

INSTALLATION AND OPERATING INSTRUCTIONS

→ DUALTHERM

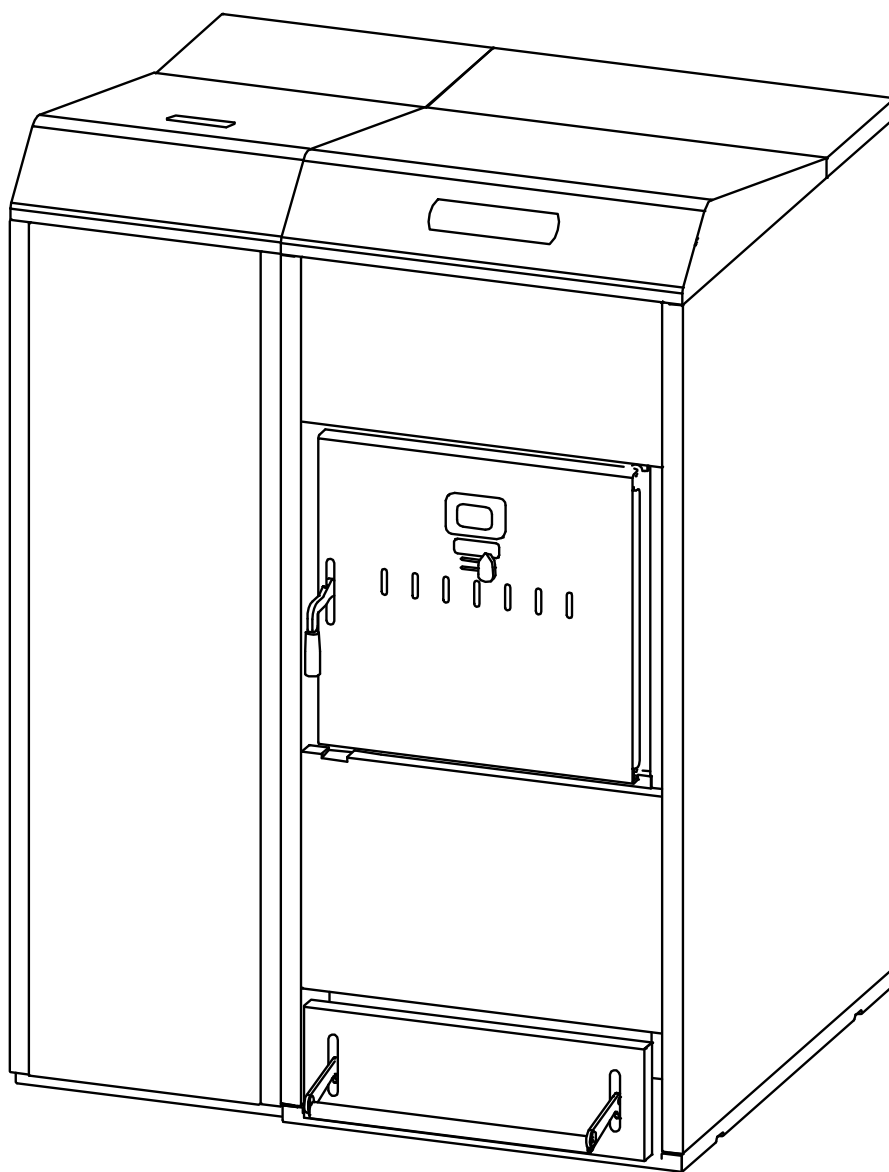

DOMUSA
T E K N I K

Thank you for choosing a DOMUSA TEKNIK heating boiler. Within the product range offered by **DOMUSA TEKNIK** you have chosen **DualTherm** model. With a suitable hydraulic installation and with a correct fuel, this boiler will provide the ideal level of comfort for your home.

This manual forms an essential part of the product and it must be given to the user. We recommend you read the warnings and recommendations in the manual carefully, as they contain important information on the safety, use and maintenance of the installation.

These boilers must be installed by qualified personnel only, in accordance with the legislation in force and following the manufacturer's instructions.

Commissioning of these boilers and any maintenance operations must only be carried out by **DOMUSA TEKNIK's** Authorised Technical Assistance Services.

Incorrect installation of these boilers could result in damage to people, animals or property, and the manufacturer will hold no liability in such cases.

DOMUSA TEKNIK informs all parties concerned that, in compliance with section 1 of the first additional provision of Law 11/1997, the responsibility for delivering packaging waste or used packaging for its proper environmental management will be that of the final owner of the product (Article 18.1 Royal Decree 782/1998). At the end of its useful life, the product must be taken to a selected collection point for electrical and electronic equipment or must be returned to the distributor at the time of purchasing a new equivalent appliance. For more detailed information on the collection schemes available, contact either the collection facilities of the local authority or the distributor where the purchase was made.

INDEX

	Page
1 LIST OF COMPONENTS.....	4
2 CONTROL COMPONENTS.....	5
3 INSTALLATION INSTRUCTIONS	6
3.1 LOCATION	6
3.2 HYDRAULIC INSTALLATION.....	6
3.3 INSTALLING THE TEMPERATURE RELIEF SAFETY VALVE	7
3.4 INSTALLING A SANIT HOT WATER TANK (OPTIONAL)	8
3.5 FEED AUGER.....	9
3.6 ELECTRICAL CONNECTION.....	10
3.7 COMBUSTION GAS EXHAUST	10
3.8 BIO HYDRAULIC KIT INSTALLATION.....	11
3.9 INSTALLATION WITH A BT BUFFER TANK	12
3.10 INSTALLATION WITH A BT-DUO BUFFER TANK (OPTIONAL)	15
4 FUEL	18
4.1 WOODEN PELLET.....	18
4.2 FIREWOOD	18
4.3 UNSUITABLE FUEL	19
5 COMMISSIONING OF THE BOILER.....	20
5.1 PRIOR WARNINGS	20
5.2 ELECTRICAL CONNECTION.....	20
5.3 FILLING THE INSTALLATION	20
5.4 INITIAL CALIBRATION OF THE FEED AUGER	20
5.5 COMMISSIONING	21
5.6 EXPLANATION TO FINAL USER	21
6 DIGITAL DISPLAY.....	22
7 COMBUSTION MODES.....	25
7.1 SELECTING AND CHANGING COMBUSTION MODES.....	25
7.2 MODE 1 (PELLET ONLY).....	25
7.3 MODE 2 (COMBINED MODE).....	26
7.4 MODE 3 (AUTOMATIC FIREWOOD).....	27
7.5 MODE 4 (MANUAL FIREWOOD).....	28
8 OPERATION.....	29
8.1 "ONLY HEATING" OPERATION	29
8.2 OPERATING WITH A SANIT DHW TANK (OPTION)	29
8.3 BOILER TEMPERATURE SET POINT SELECTION.....	30
8.4 DHW TEMPERATURE SET POINT SELECTION (WITH DHW TANK INSTALLED ONLY).....	30
8.5 SELECTING THE SET POINT TEMPERATURE OF THE BUFFER TANK (ONLY WITH BUFFER TANK).....	31
8.6 FUNCTIONING ACCORDING TO OUTDOOR TEMPERATURE CONDITIONS OTC (OPTION).....	31
9 OPERATING WITH BIO HYDRAULIC KITS (OPTIONAL).....	32
10 OPERATION WITH A BT BUFFER TANK	33
10.1 OPERATION WITH A TEMPERATURE SENSOR IN THE BT BUFFER TANK (P.08 = 1 OR 2)	33
10.2 OPERATION WITH A CONTROL THERMOSTAT IN THE BT BUFFER TANK (P.08 = 3 OR 4).....	34
11 OPERATION WITH A BT-DUO BUFFER TANK (OPTIONAL).....	35
12 OPERATING WITH LAGO FB OT+ REMOTE CONTROL (OPTIONAL)	36
13 USER MENU.....	37
14 SETUP MENU.....	39
14.1 TIMERS PROGRAMMING PROCESS.....	40
14.2 BOILER TIMER PROGRAMMING	40
14.3 CVS SUCTION SYSTEM TIMER PROGRAMMING (CVS SUCTION SYSTEM OPTION ONLY).....	40
14.4 DHW RECIRCULATION FUNCTION TIMER PROGRAMMING (DHW TANK OPTION ONLY).....	41
14.5 TIME SETTING	41
14.6 MANUAL SETTING OF FEED AUGER CALIBRATION.....	41
14.7 SCREEN CONTRAST SETTING.....	41

DualTherm

15 CALIBRATION MENU.....	42
15.1 FEED AUGER FILLING.....	43
15.2 FEED AUGER CALIBRATION.....	44
15.3 MANUAL SETTING OF FEED AUGER CALIBRATION.....	45
15.4 MANUAL ASH CLEANING ACTIVATION.....	45
15.5 MANUAL CIRCULATION PUMPS ACTIVATION.....	45
16 TECHNICAL MENU.....	45
16.1 ENTRY AND SET THE ACCESS CODE ("COD", P.25).....	48
17 BOILER'S SETUP PARAMETERS.....	49
17.1 BOILER MODEL (P.01).....	49
17.2 BOILER HEAT OUTPUT (P.02, P.03).....	49
17.3 GENERAL FAN SPEED FACTOR (P.04).....	49
17.4 FUEL FOR IGNITION (P.05).....	49
17.5 FUEL CONSUMPTION (P.06).....	49
17.6 MANAGING BT AND BT-DUO BUFFER TANKS (P.08, P.28).....	50
17.7 BOILER MINIMUM TEMPERATURE MODE (P.13, P.14).....	50
17.8 FIREWOOD FIRING POWER ADJUSTMENT (P.32).....	50
17.9 MINIMUM FIREWOOD COMBUSTION POWER ADJUSTMENT (P.33).....	50
17.10 FAN SPEED DURING MANUAL FIREWOOD FIRING (P.34).....	50
18 HEATING CIRCUIT'S SETUP PARAMETERS.....	51
18.1 HEATING PUMP POST-CIRCULATION TIME (P.15).....	51
18.2 BOILER'S PUMP OPERATING MODE (P.18).....	51
18.3 MINIMUM BOILER WATER PRESSURE (P.19).....	51
18.4 MAXIMUM HEATING FLOW TEMPERATURE OF MIXED CIRCUITS (P.27).....	51
19 DHW CIRCUIT'S SETUP PARAMETERS.....	51
19.1 DHW INSTALLATION MODE (P.09).....	52
19.2 DHW PUMP POST-CIRCULATION TIME (P.16).....	52
19.3 LEGIONELLA PROTECTION FUNCTION (P.17).....	52
19.4 DHW RE-CIRCULATION FUNCTION (P.20 = 2).....	52
20 ADDITIONAL FUNCTIONS.....	52
20.1 CVS SUCTION SYSTEM CYCLE TIME (P.22).....	52
20.2 RESET DEFAULT VALUES (P.24).....	52
20.3 PUMPS ANTI-LOCK FUNCTION.....	52
20.4 ANTI-FROST FUNCTION.....	53
20.5 BOILER PRESSURE SENSOR FUNCTION.....	53
20.6 CONNECTING THE LAGO FB OT+ REMOTE CONTROL.....	53
20.7 ROOM THERMOSTAT CONNECTION.....	53
21 MULTI-FUNCTIONAL RELAY (P.20).....	54
21.1 BOILER ALARMS EXTERNAL SIGNAL (P.20 = 1).....	54
21.2 DHW RE-CIRCULATION FUNCTION (P.20 = 2).....	54
21.3 AUTOMATIC WATER FILLING FUNCTION (P.20 = 3).....	54
22 CLEANING THE ASH DRAWER.....	55
22.1 SAFETY WARNINGS:.....	55
23 AIR ADJUSTMENT.....	56
24 SAFETY LOCK-OUTS.....	57
24.1 WATER OVERHEAT SAFETY CUT-OUT (E-11).....	57
24.2 FUEL INLET TUBE OVERHEAT SAFETY LOCK-OUT (E-05).....	57
24.3 LOW PRESSURE LOCK-OUT.....	58
25 SHUTTING DOWN THE BOILER.....	58
26 EMPTYING THE BOILER.....	58
27 BOILER MAINTENANCE.....	59
27.1 FREQUENCY OF MAINTENANCE OF THE BOILER AND CHIMNEY.....	59
27.2 BURNER CLEANING PROCEDURE.....	60
27.3 CLEANING THE VENTS AND REAR ASH DRAWER.....	61
27.4 DEFLECTOR.....	62

27.5 FUME TEMPERATURE SENSOR	62
27.6 DRAINING THE CONDENSATE WATER	62
27.7 BOILER WATER CHARACTERISTICS.....	62
28 DIAGRAMS AND MEASUREMENTS.....	63
29 CONNECTIONS DIAGRAM.....	64
29.1 BOILER	64
29.2 BURNER.....	65
30 ELECTRICAL DIAGRAM.....	66
31 TECHNICAL DATA	67
32 CIRCULATION PUMP AND PRESSURE DROP	68
32.1 HIGH EFFICIENCY CIRCULATION PUMP	68
33 SPARE PARTS LIST.....	70
34 ALARM CODES	83

1 LIST OF COMPONENTS

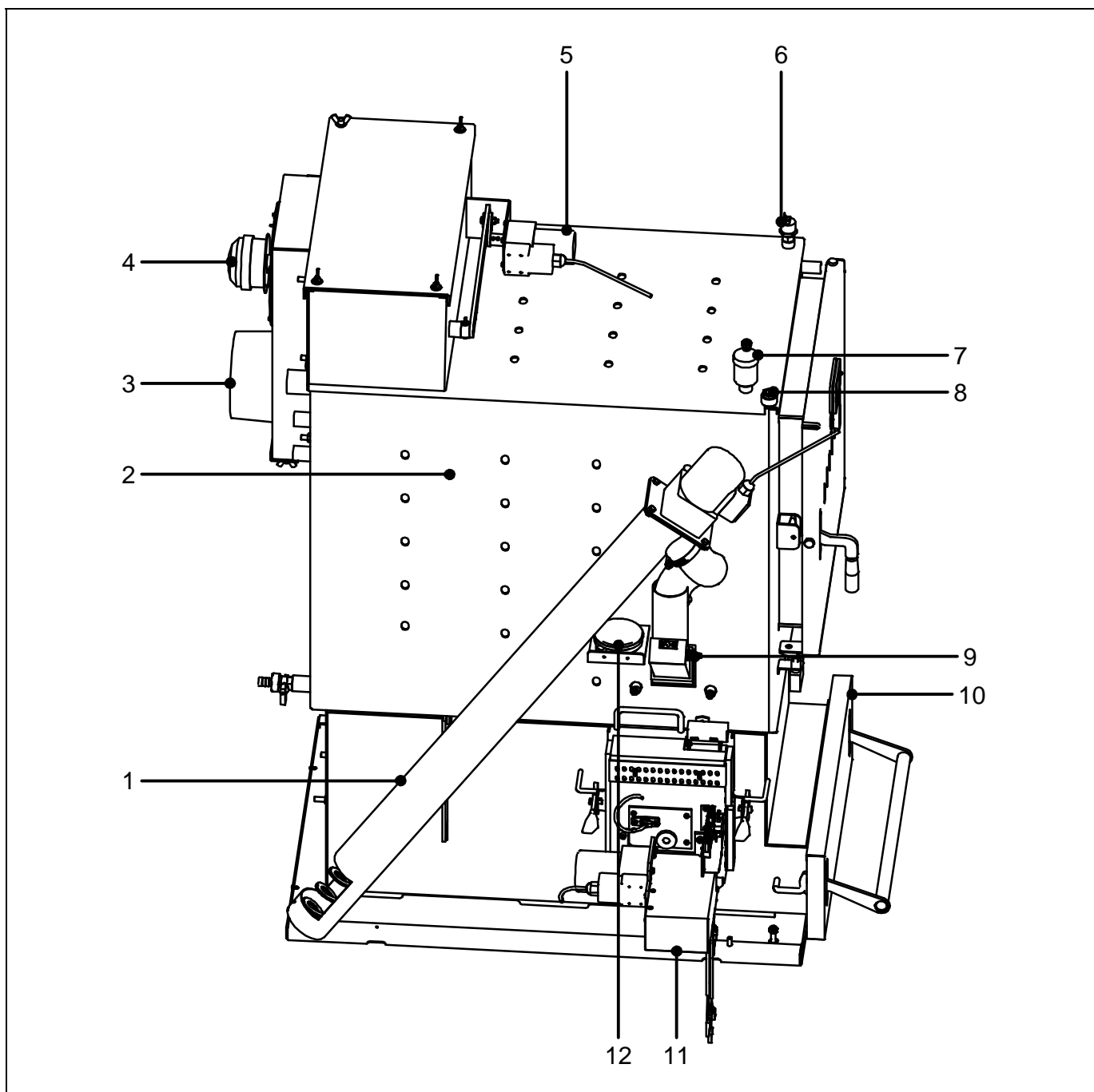

1. Feed auger.

2. Heat exchanger.

3. Flue outlet

4. Fan.

5. Heat exchanger cleaning system.

6. Water pressure sensor.

7. Automatic Air vent.

8. Sensor sheath.

9. Fuel inlet safety thermostat.

10. Ash tray.

11. Burner.

12. Air pressure sensor.

2 CONTROL COMPONENTS

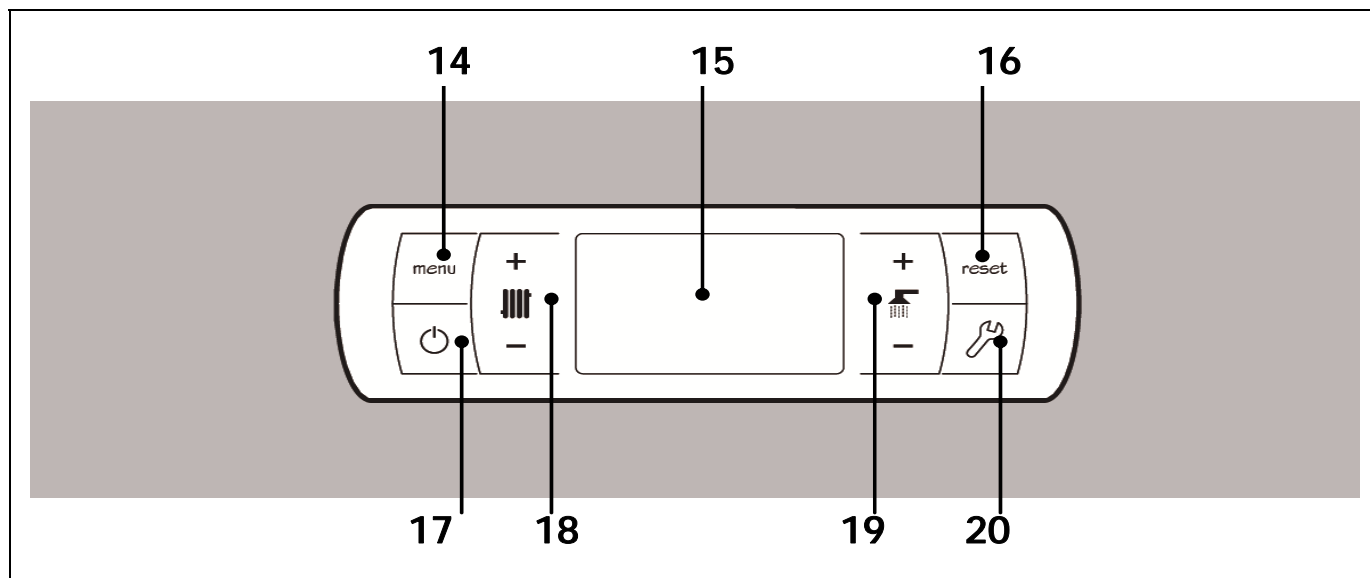

14. MENU touch button:

This button is used to access and browse through the "User Menu".

15. Digital display:

It is the main boiler functioning display, on which all the operating information, settings and values appear. This display is also used to access the appliance's user and service settings. In standard operating mode (default display), the actual boiler temperature is shown. If malfunction occurs, an alarm code will appear on the digital display instead of the temperature.

16. RESET touch button:

This button is used to restore functioning of the boiler after a lock-out situation. Also it is used to exit from any of the menus or parameters of the boiler without saving it and to return to the previous menu level.

17. ON touch button:

This button switches on and off the boiler.

18. Boiler temperature touch button:

This button is used to select the boiler set point temperature. It is also used to disable the hot water function.

19. DHW temperature touch button:

This button is used to select the desired domestic hot water set point temperature (only if a DHW tank is connected to the boiler). It is also used to disable the DHW function.

20. SET touch button:

This button is used to access and browse through the "Setup menu". Touch this button to access the settings options.

3 INSTALLATION INSTRUCTIONS

The boiler must be installed by authorised personnel in compliance with the applicable laws and regulations.

This boiler is suitable for heating water to a temperature below boiling point at atmospheric pressure. It must be connected to a heating installation and/or a domestic hot water distribution network, which must always be compatible with its performance and power.

This appliance must only be used for the purpose for which it has been expressly designed. Any other use is considered unsuitable and therefore hazardous. The manufacturer shall not be considered liable under any circumstances for damage caused by unsuitable, erroneous or irrational use.

Remove all the packaging and check the contents are complete. In case of doubt, do not use the boiler. Contact your supplier. Keep the packaging elements out of reach of children, as they can be dangerous.

When you no longer wish to use the boiler, disable the parts that could be a potential source of hazard.

3.1 Location

The boiler must be installed in a sufficiently ventilated site, away from humidity. It must be located so that the air grilles on the premises are not obstructed and normal boiler maintenance is possible even if it is placed between items of furniture. Therefore, a free distance of at least a half metre should be left between the reserve tank and the wall, as well as a free distance of one metre above the boiler.

If, for transport reasons, the boiler volume must be reduced, it is possible to separate the boiler-hopper body assembly. To do this, release the pellet burner connectors.

3.2 Hydraulic installation

The hydraulic installation must be made by qualified personnel. The applicable installation legislation is to be complied with, and the following recommendations should also be taken into account:

- The inside of the installation piping should be thoroughly cleaned before switching on the boiler.
- It is recommended inserting cut-off valves between the installation piping and the boiler to simplify maintenance tasks.
- Leave a free space around the boiler for carrying out any maintenance and repair operations.
- Drain valves and suitable devices for correctly bleeding the air from the circuit during the boiler filling stage should be fitted.
- Install all the necessary safety elements (expansion vessel, safety valve, etc.) to comply with the applicable regulations for the installation.
- If the boiler is installed at a lower height than the heating installation, it is recommended to create a siphon at the boiler outlet, to prevent the installation from heating up due to natural convection when heating is not required.
- It is advisable to install a buffer. The minimum volume of the buffer tank must be calculated based on Standard EN 303-5.

- It is imperative and obligatory to install a heating water buffer when the heating system has a mixed circuit for under-floor heating (see "Example of installation of a buffer"). The minimum volume of the buffer tank should be calculated based on Standard EN 303-5.
- It is obligatory and essential to install a device for raising the return temperature up to 65°C, to prevent any water condensation in the heat exchanger. If this requirement is not complied with, DOMUSA TEKNIK's guarantee of the appliance will automatically be null and void.
- It is obligatory to install a thermal discharge valve tared at 95-97°C (optionally supplied by DOMUSA TEKNIK). To correctly install the boiler, carefully follow the instructions given in section "Installing the temperature relief safety valve". If this requirement is not complied with, DOMUSA TEKNIK's guarantee of the appliance will automatically be null and void.

3.3 Installing the temperature relief safety valve

In order to avoid the temperature inside the boiler reaching damaging levels, this valve opens and lets the mains water supply pass through the interior coil, thereby dispelling the heat. This occurs when, for hydraulic reasons or due to lack of electric power supply, the boiler cannot dispel the heat it is generating. **The valve is obligatory in DualTherm boiler installations.**

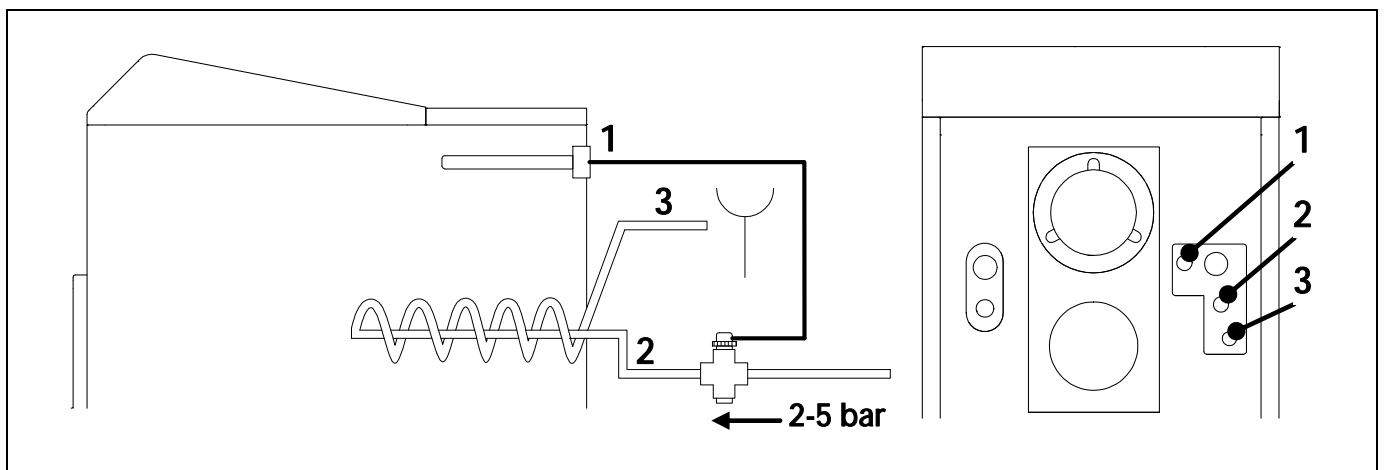

- | | |
|------------------------|-----------------------|
| 1. Thermostatic sheath | 3. Drain water outlet |
| 2. Mains water inlet | |

The valve is regulated by the hot water from the boiler. If the water temperature is higher than 95°C, the valve lets the mains water go through the interior coil. This water moving in the coil absorbs the boiler heat, preventing overheating and damage the boiler.

The thermal discharge valve should be connected to the tundish. The connection must not be blocked manually. Furthermore, access must be granted to the heat protection mechanism and to the cleaning inspection, once assembled. The minimum connection pressure for the safety heat exchanger is 2 bars. The nominal pressure of the valve is 5 bars.

The temperature relief valve is installed upstream of the coil (placed respecting the flow direction according to the arrow on the coil). The mains water supply must be connected directly to the temperature relief valve. The immersion sheath should be placed in the appropriate socket, as shown in the diagram.

IMPORTANT: It should not be possible to close the supply pipe so as to avoid any accidental blockage.

IMPORTANT: The cold water pressure should not depend on the power supply.

IMPORTANT: The pipe must be thoroughly washed before installation.

DualTherm

3.4 Installing a Sanit hot water tank (Optional)

For a correct electrical connection of a Sanit DHW tank with **DualTherm** boiler, these steps should be followed:

- **Unplug the boiler from the mains.**
- Connect a DHW temperature sensor (supplied optionally) to the sensor terminal strip **J7 (Sa; terminals 18 and 19)** (see "*Connections Diagram*").
- Insert the temperature sensor bulb in the bulb-holder sheath provide on the hot water tank.
- Connect the 3-way DHW diverter valve or the hot water tank pump (depending on the installation, modify parameter **P.09**) to the supply terminal strip **J3 (BA; terminals 6 and N)** (see "*Connections Diagram*").

The hydraulic installation for the 3-way DHW diverter valve should be made so that the heating circuit can flow through the valve when it is in rest position (not energised):

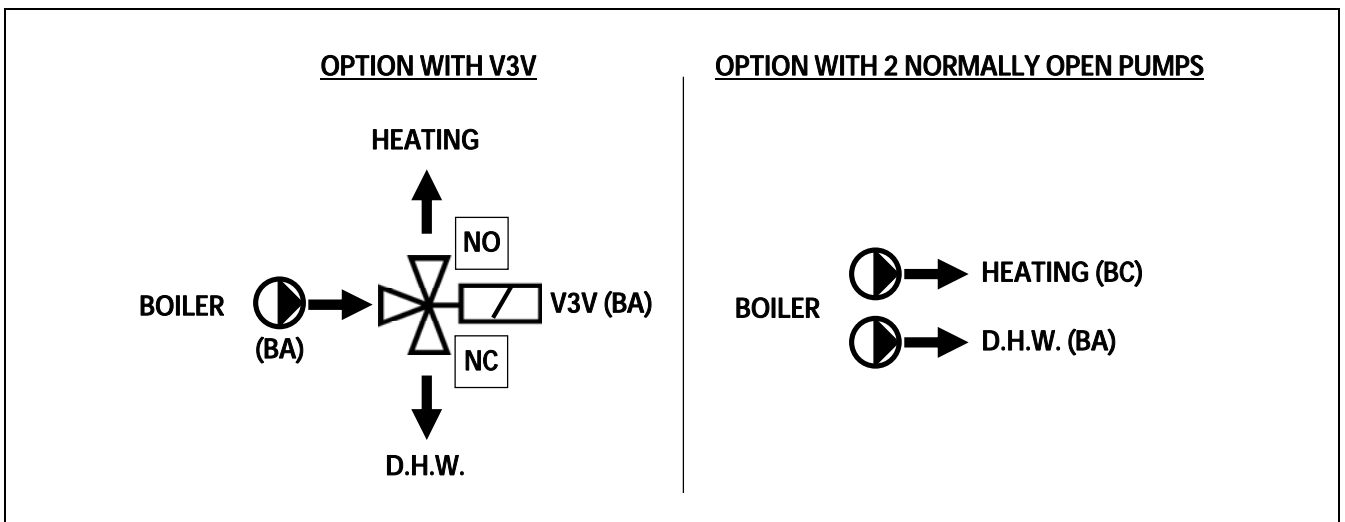

For correct hydraulic installation of the DHW tank, carefully follow the assembly and connection instructions enclosed with the same.

3.5 Feed auger

The **DualTherm** boiler is equipped with a hopper for pellet storing.

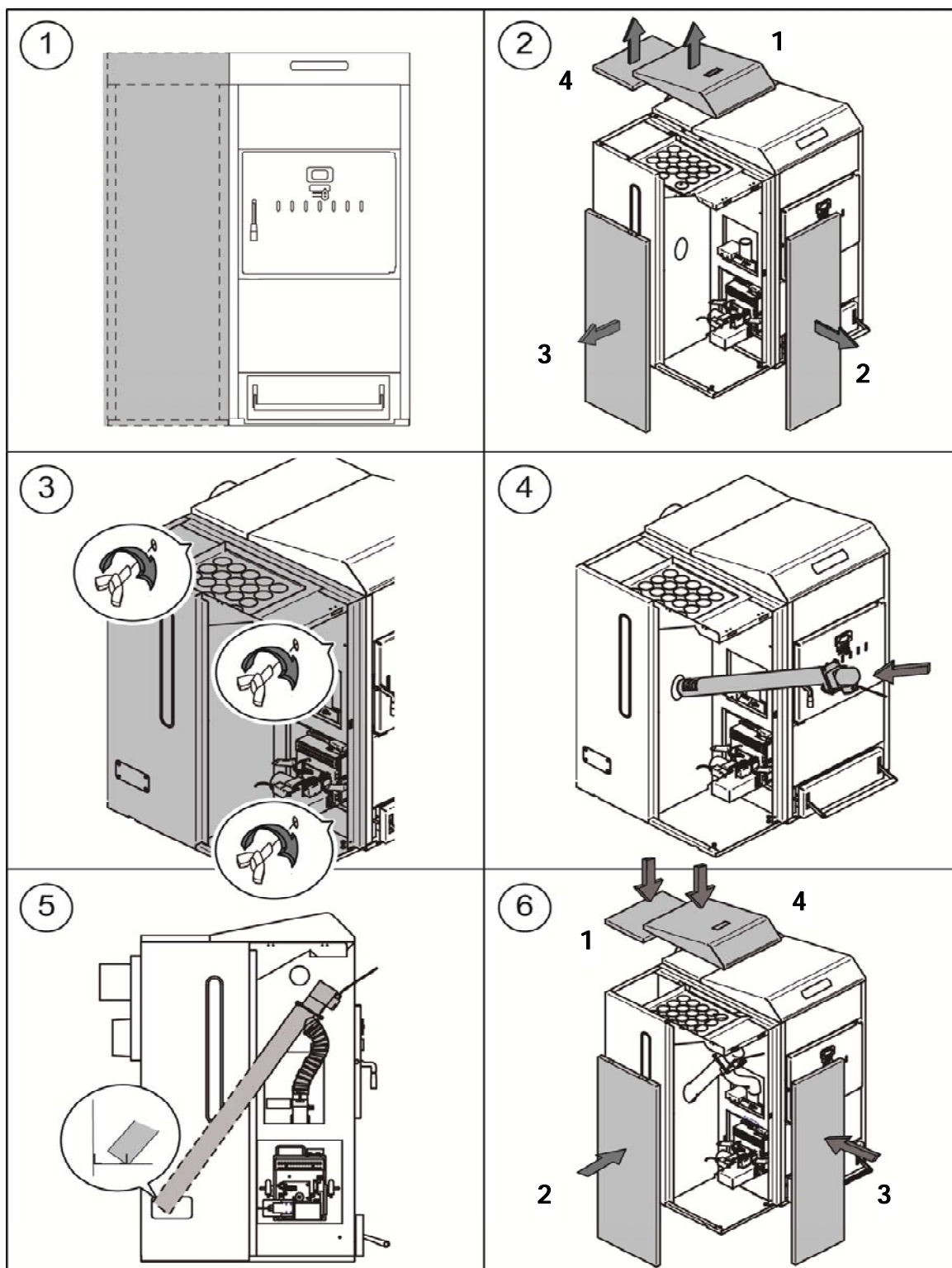

NOTE: The screws to fasten the hopper with the boiler are contained in the documentation bag.

NOTE: Position the flexible hose in such a way as to allow the feeding of the pellets with the least possible resistance to the burner.

DualTherm

3.6 Electrical Connection

The boiler is suitable for a 230 V~, 50 Hz to terminals 1 and 2 of terminal strip J1 (see "Electrical Connection Diagram"). **The ground terminal should also be connected.**

The boiler has a strip TA₁ (J6), prepared for connecting a room thermostat or room chronothermostat (see *Electrical Connection Diagram*) for remote control of the heating circuit. To correctly connect the room thermostat, remove the bridge joining the terminals on the strip TA₁. Optionally, connection strip J5 can be connected to a Lago FB OT for controlling remotely the DHW and circuits (see "Use of LAGO FB OT").

The terminal strip J2 includes terminals for connecting the feed auger, whereas the terminal strip J3 includes terminals for connecting the circulation pump of the boiler (BC) and the 3-way diverter valve (or circulation pump) for the optional DHW circuit. The terminal strip J7 includes terminals for connecting a sensor for the optional DHW circuit. This sensor must be supplied by **DOMUSA TEKNIK**.

IMPORTANT: Before carrying out any work on the boiler's electrical installation, always ensure it is disconnected from the mains.

3.7 Combustion gas exhaust

The **DualTherm** boiler is a biomass boiler and it must be connected to a flue, i.e. a smoke duct able to create a pressure drop (which in this case should be between 0.10 and 0.20 mbar), in compliance with the applicable laws to this regard.

The combustion product exhaust ducts must be installed by qualified personnel and must comply with the regulations in force. For the flue to create a pressure drop, the following recommendations should be taken into account:

- The flue should be thermally insulated.
- It should be independently located, with a separate flue for each boiler.
- It should be vertical, avoiding any angles greater than 45°.
- It should always have the same diameter. It is recommendable for it to be circular, and never any narrower than the boiler outlet.
- **It is obligatory to install a fume inspection plate with a condensate collector, to remove the condensation generated in the flue.** Otherwise, the condensation may reach the inside of the boiler and cause irreparable damage, **which would not be covered by DOMUSA TEKNIK's guarantee. The condensation pipe should lead to a drain outlet**, as a large amount of water may be generated. This connection must be made in compliance with the regulations for draining off condensation water to the drain network.
- **It is recommended to install a draught stabiliser** to prevent any pressure drop variations in the flue due to atmospheric conditions, which could affect correct boiler combustion. **This draught stabiliser must be installed below the fume inspection plate to prevent any leakage of combustion gases.**

3.8 BIO hydraulic kit installation

Optionally, a **BIO hydraulic kit**, within the kits range offered by **DOMUSA TEKNIK**, could be connected to **DualTherm** boiler. In that way the features of the boiler will be increased. **It is imperative and obligatory to install a buffer tank when the heating system has a mixed circuit for under-floor heating** (see "Example of installation of a buffer").

Look at the following instructions for a correct installation:

- **Unplug the boiler and the hydraulic kit from the main power supply.**
- Connect the communication between the boiler and BIO hydraulic kit. Use the cable of two wires with two connectors (+A –B) supplied with the kit (documentation bag). **To assure the correct running of BIO hydraulic Kit it is essential to respect the polarity of the connection. The same wire must be connected to the +A terminal of the boiler as well as to the +A terminal of the hydraulic Kit. Same operation with the –B terminals as it is shown in the picture below.**
- After connecting the boiler and the hydraulic Kit, plug the **BIO hydraulic Kit** to the main power supply. It is recommended to plug the Kit before the boiler to ensure the correct performance of the system.
- Plug the boiler to the main power supply.

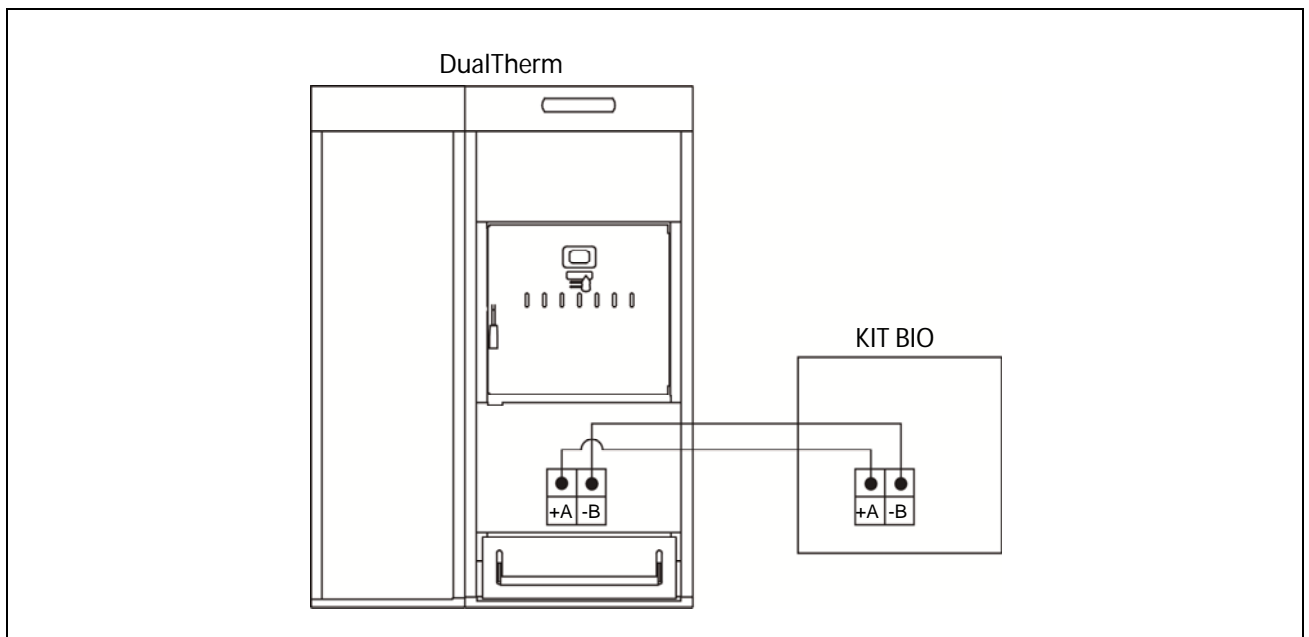

Follow the instructions provided with the kit to assure a correct installation.

IMPORTANT: It is compulsory to respect the polarity of both wires of the cable to assure a correct performance of BIO hydraulic Kit.

NOTE: It is recommended to plug the kit before the boiler to assure a correct performance.

DualTherm

3.9 Installation with a BT Buffer Tank

The **DualTherm** boiler can be installed with a **BT Buffer Tank** during the installation from the wide range offered by DOMUSA TEKNIK, which may increase the benefits provided by the boiler in the heating service.

For this reason, the electronic control of the boiler is equipped with an input for a temperature sensor or a temperature thermostat (**Sbt**; terminals 18-19 on connection strip **J7**) and a circulation pump output (**Bbt**; terminals N-7 on the connection strip **J2**) dedicated exclusively to managing the heating of the buffer tank. Using these control elements of the boiler it is possible to manage 4 different modes of buffer tank hydraulic installation. The installation type will be selected using parameter **P.08** in the "Technician" menu on the control panel.

The boiler is supplied with this installation option disabled. To enable it, the electrical resistance (**Rbt**) connected between terminals **20** and **21** of connection strip **J7** (see "Connection Diagram") must be removed and replaced with a temperature sensor (supplied as an option by DOMUSA TEKNIK) or a control thermostat installed in the BT buffer tank. After disconnecting the **P.08** parameter "Technician" menu of the control panel must be enabled, from where you can select the installation mode desired.

3.9.1 Installation with Sanit DHW tank after BT tank and control by temperature sensor (P.08 = 1)

In this installation mode, all heating circuits, as well as the circuit for DHW production by accumulation must be hydraulically connected to the BT buffer tank. In other words, as shown in the following hydraulic diagram, the BT buffer tank is connected to the boiler, interposing a circulation pump (**Bbt**), and all the heating circuits of the system are connected to the BT tank. The temperature of the BT tank is controlled and managed by a temperature sensor (**Sbt**) immersed in the buffer tank and electrically connected to the boiler. The temperature sensor is optionally supplied by DOMUSA TEKNIK.

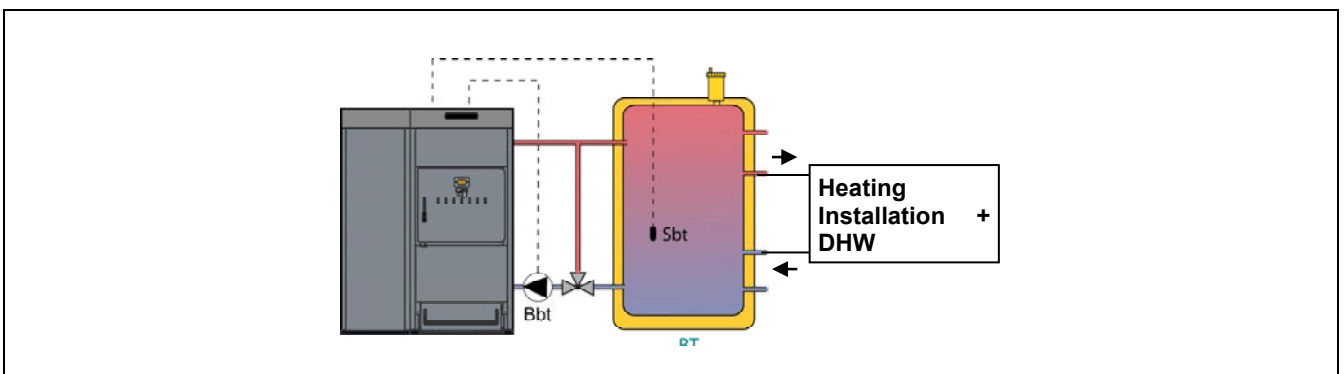

After the hydraulic installation of all the system components, proceed as follows to carry out the correct electrical connection of the BT buffer tank to the **DualTherm** boiler:

- **Unplug the boiler from the mains.**
- Disconnect the electrical resistance (**Rbt**) connected between terminals **20** and **21** of connection strip **J7** (see "Connection Diagram").
- Connect the BT tank temperature sensor (supplied optionally) to the sensor connection strip **J7** (**Sbt**; terminals **20** and **21**) (see "Connection Diagram").
- Insert the temperature sensor bulb in the bulb-holder sheath provided in the buffer tank.
- Connect the BT tank feed pump to the terminal strip **J2** (**Bbt**; terminals **N** and **7**) (see "Connection Diagram").
- Connect the boiler to the mains power.

- Using the control panel, access parameter **P.08** in the "Technician" menu (see "Technician Menu") and set the value to "1".
- If it is necessary, set the parameter **P.28** "BT buffer tank temperature hysteresis".

Once the hydraulic and electrical connections described above have been completed, read carefully the section "Operation with a BT buffer tank" to adjust and configure the BT buffer tank operation.

3.9.2 Installation with Sanit DHW tank before BT tank and control by temperature sensor (P.08 = 2)

In this installation mode, all heating circuits must be hydraulically connected to the BT buffer tank, and the circuit for producing DHW by accumulation should be hydraulically connected to the boiler, upstream from the BT buffer tank. The BT buffer tank and the Sanit DHW tank, if present, are connected in parallel to the boiler. Depending on the type of installation of the DHW tank, the BT tank feed pump (**Bbt**) will be installed as indicated in the following hydraulic diagrams. The temperature of the BT tank is controlled and managed by a temperature sensor (**Sbt**) immersed in the buffer tank and electrically connected to the boiler. The temperature sensor is optionally supplied by DOMUSA TEKNIK.

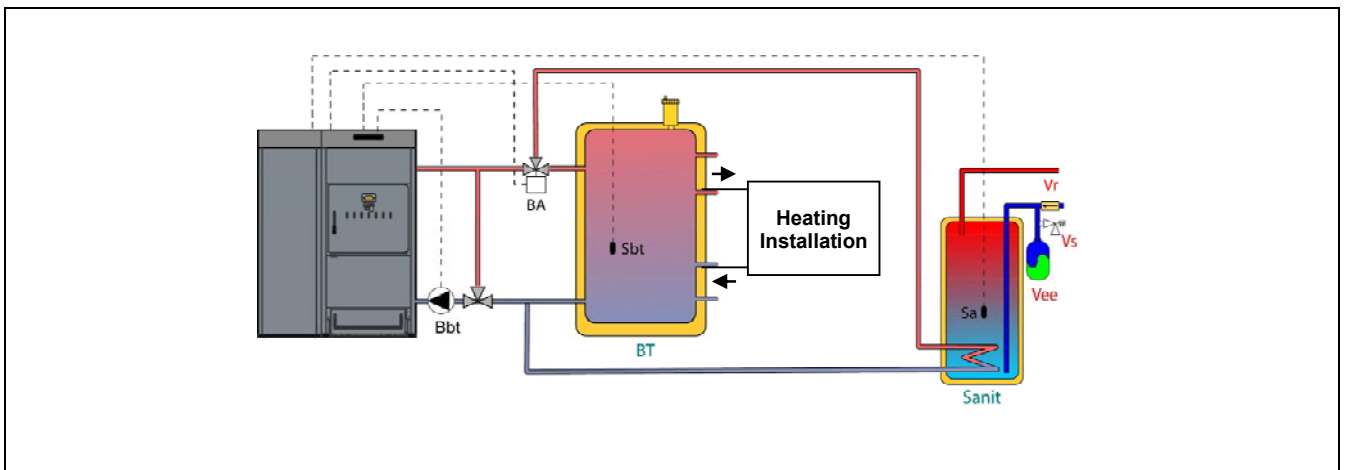

After the hydraulic installation of all the system components, proceed as follows to carry out the correct electrical connection of the BT buffer tank to the **DualTherm** boiler:

- **Unplug the boiler from the main.**
- Disconnect the electrical resistance (**Rbt**) connected between terminals **20** and **21** of connection strip **J7** (see "Connection Diagram").
- Connect the BT tank temperature sensor (supplied optionally) to the sensor connection strip **J7** (**Sbt**; terminals **20** and **21**) (see "Connection Diagram").
- Insert the temperature sensor bulb in the bulb-holder sheath provided in the buffer tank.
- Connect the BT tank feed pump to the component connection strip **J2** (**Bbt**; terminals **N** and **7**) (see "Connection Diagram").
- Connect the boiler to the mains.
- Using the control panel, access parameter **P.08** in the "Technician" menu (see "Technician Menu") and set the value to "2". Next, access parameter **P.09** from the same menu and set the value to "0".
- After that, if it is necessary, set also the parameter **P.28** "BT buffer tank temperature hysteresis".

For the correct hydraulic and electrical installation of a Sanit DHW tank with a **DualTherm** boiler, carefully follow the directions in the section "Installing a Sanit tank" in this manual.

DualTherm

Once the hydraulic and electrical connection described above has been completed, to adjust and configure the BT buffer tank operation, carefully read the section "Operation with a BT buffer tank" in this manual.

3.9.3 Installation with Sanit DHW tank after BT tank and control by thermostat (P.08 = 3)

In this installation mode, all heating circuits, as well as the circuit for producing DHW by accumulation, if present, must be hydraulically connected to the BT buffer tank. In other words, as shown in the following hydraulic diagram, the BT buffer tank is connected to the boiler, interposing a circulation pump (**Bbt**), and all the heating circuits of the system are connected to the BT tank. The temperature of the BT tank is controlled and managed by a thermostat (**Tbt**) installed and immersed in the buffer tank and electrically connected to the boiler. The temperature control thermostat is not supplied by DOMUSA TEKNIK but can be purchased at any specialist central heating supplies warehouse.

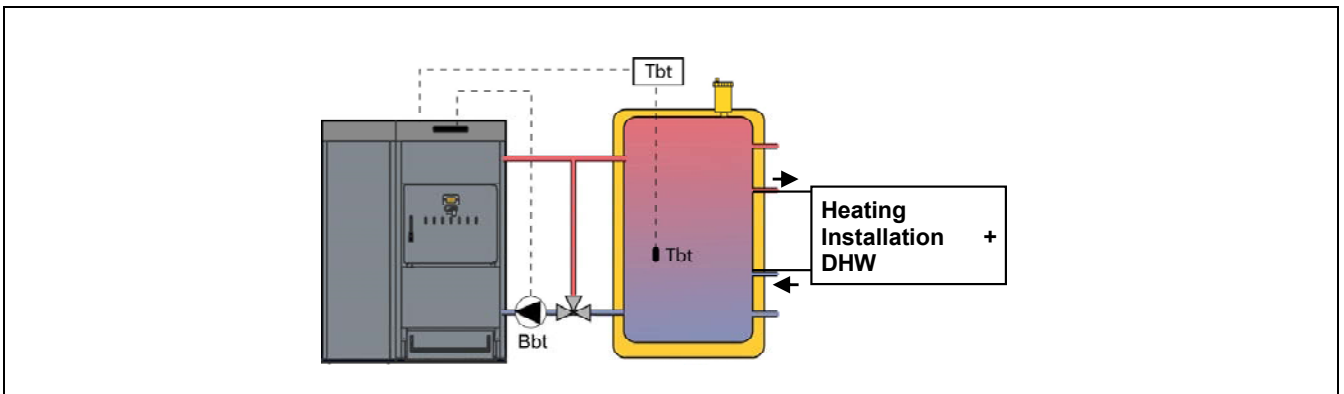

After the hydraulic installation of all the system components, proceed as follows to carry out the correct electrical connection of the BT buffer tank to the **BioClass HM** boiler:

- **Unplug the boiler from the mains.**
- Disconnect the electrical resistance (**Rbt**) connected between terminals **20** and **21** of connection strip **J7** (see "Connection Diagram").
- Connect the **NC** contact (normally closed) on the BT tank control thermostat on the sensor connection strip **J7** (**Sbt**; terminals **20** and **21**) (see "Connection Diagram").
- Insert the thermostat bulb into the bulb-holder sheath provided in the buffer tank.
- Connect the BT tank feed pump to the component connection strip **J2** (**Bbt**; terminals **N** and **7**) (see "Connection Diagram").
- Connect the boiler to the mains power.
- Using the control panel, access parameter **P.08** in the "Technician" menu (see "Technician Menu") and set the value to **"3"**.

Once the hydraulic and electrical connection described above has been completed, to adjust and configure the BT buffer tank operation, carefully read the section "Operation with a BT buffer tank" in this manual.

3.9.4 Installation with Sanit DHW tank before BT tank and control by thermostat (P.08 = 4)

In this installation mode, all heating circuits must be hydraulically connected to the BT buffer tank, and the circuit for producing DHW by accumulation should be hydraulically connected to the boiler, upstream from the BT buffer tank. In other words, the BT buffer tank and the Sanit DHW tank, if present, are connected in parallel to the boiler. Depending on the type of installation of the DHW tank, the BT tank feed pump (**Bbt**) will be installed as indicated in the following hydraulic diagrams. The temperature of the BT tank is controlled and managed by a thermostat (**Tbt**) installed and

immersed in the buffer tank and electrically connected to the boiler. The temperature control thermostat is not supplied by DOMUSA TEKNIK but can be purchased at any specialist central heating supplies warehouse.

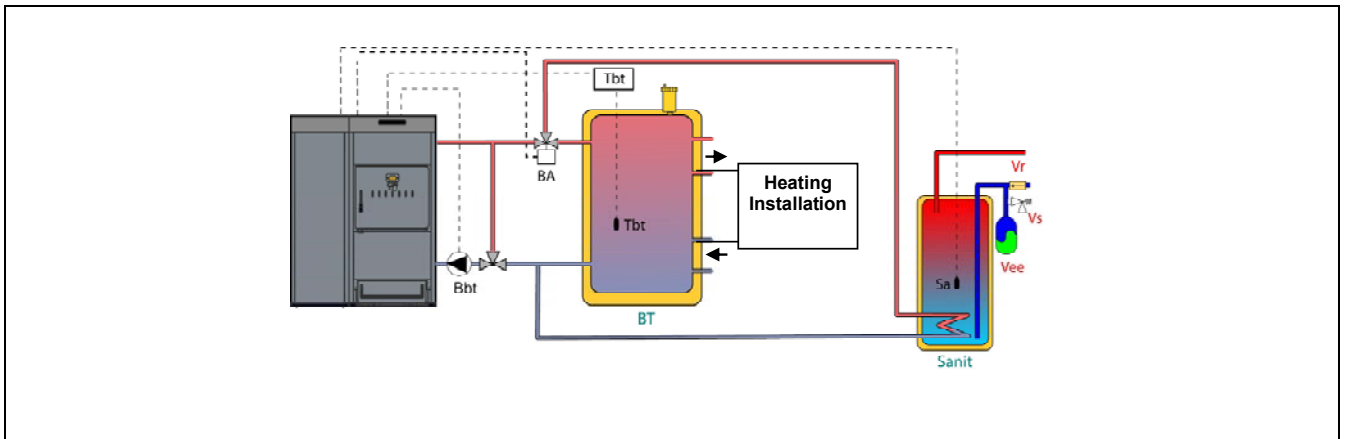

After the hydraulic installation of all the system components, proceed as follows to carry out the correct electrical connection of the BT buffer tank to the **DualTherm** boiler:

- **Unplug the boiler from the mains power.**
- Disconnect the electrical resistance (**Rbt**) connected between terminals **20** and **21** of connection strip **J7** (see "Connection Diagram").
- Connect the **NC** contact (normally closed) on the BT tank control thermostat on the sensor connection strip **J7** (**Sbt**; terminals **20** and **21**) (see "Connection Diagram").
- Insert the thermostat bulb into the bulb-holder sheath provided in the buffer tank.
- Connect the BT tank feed pump to the component connection strip **J2** (**Bbt**; terminals **N** and **7**) (see "Connection Diagram").
- Connect the boiler to the mains power.
- Using the control panel, access parameter **P.08** in the "Technician" menu (see "Technician Menu") and set the value to "**4**". Next, access parameter **P.09** from the same menu and set the value to "**0**".

For the correct hydraulic and electrical installation of a Sanit DHW tank with a **DualTherm** boiler, carefully follow the directions in the section "Installing a Sanit tank" in this manual.

Once the hydraulic and electrical connection described above has been completed, to adjust and configure the BT buffer tank operation, carefully read the section "Operation with a BT buffer tank" in this manual.

3.10 Installation with a BT-DUO buffer tank (Optional)

The **DualTherm** boiler can be accompanied by a **BT-DUO Buffer Tank** during the installation from the wide range offered by DOMUSA TEKNIK, which may increase the benefits provided by the boiler in the heating service. This tank has a hot water storage tank inside, thereby adding the provision of DHW in addition to the buffer tank functionality. For this reason, its connection to the boiler as well as its operating configuration are specific.

For this reason the electronic control of the boiler is equipped with an input for connecting the primary control thermostat **Tcp** of the BT-DUO tank (input **Sbt**; terminals 20-21 on connection strip **J7**) and a circulation pump output (**Bbt**; terminals N-7 on the connection strip **J2**) dedicated exclusively to managing the heating of the buffer tank. Also, for correctly managing the DHW production in the tank integrated in the BT-DUO tank, a DHW temperature sensor (supplied optionally) must be included in the installation.

DualTherm

The boiler is supplied with this installation option disabled. To enable it, the electrical resistance (**Rbt**) connected between terminals **20** and **21** of connection strip **J7** (see "Connection Diagram") must be disconnected and replaced with a temperature sensor (supplied as an option by DOMUSA TEKNIK) or a control thermostat installed in the BT buffer tank. After disconnecting the resistance in the "Technician" menu of the control panel, parameter **P.08** must be enabled, via which you can select the installation mode and appropriate functioning for this type of buffer tank.

The BT-DUO buffer tank is hydraulically connected to the boiler, interposing a circulation pump (**Bbt**), and all the central heating circuits of the system are connected to the BT-DUO tank. For the correct hydraulic installation of the **BT-DUO** tank and the feed pump **Bbt**, carefully follow the instructions in the following hydraulic diagram:

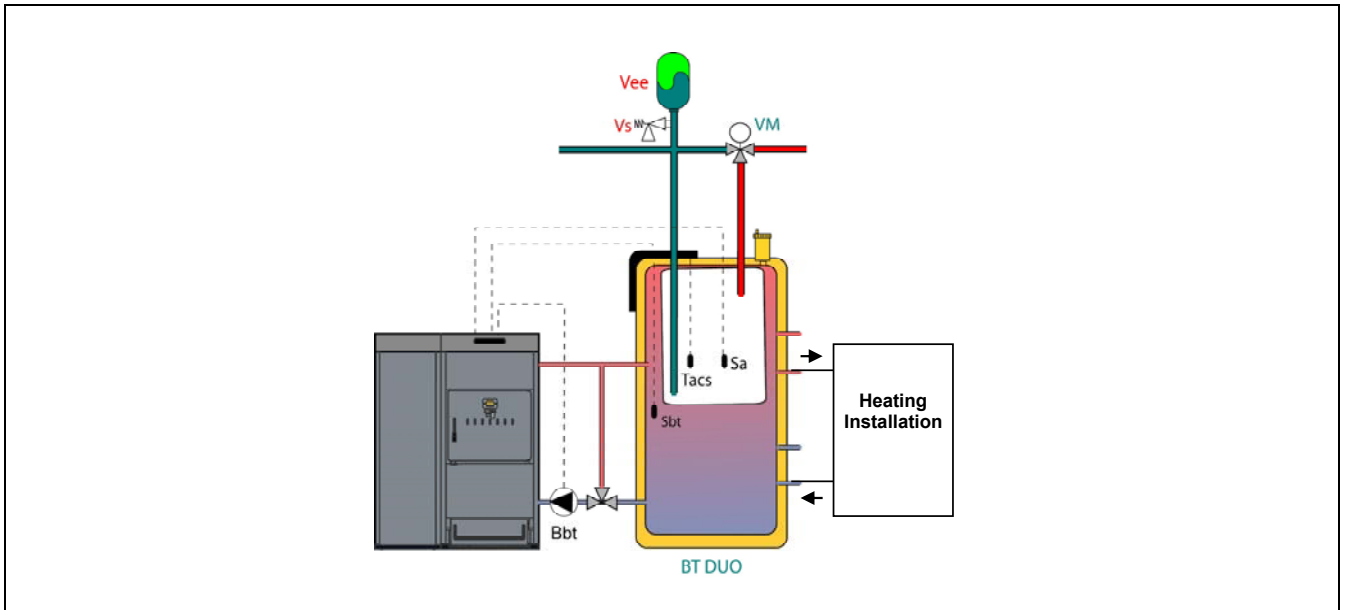

After the hydraulic installation of all the system components, proceed as follows to carry out the correct electrical connection of the BT-DUO buffer tank to the **DualTherm** boiler:

- **Unplug the boiler from the mains power.**
- Disconnect the electrical resistance (**Rbt**) connected between terminals **20** and **21** of connection strip **J7** (see "Connection Diagram").
- Using a 2-wire electrical hose connect the **TAcald** terminals (terminals **7** and **8** in the wiring diagram of the BT-DUO tank manual) of the BT-DUO tank control thermostat (**Tcp**) to the sensor connection strip **J7** (**Sbt**; terminals **20** and **21**) (see "Connection Diagram").
- Connect the DHW temperature sensor (supplied optionally) to the sensor connection strip **J7** (**Sa**; terminals **18** and **19**) (see "Connection Diagram"), previously removing the resistance **Ra**, supplied as standard with the boiler.
- Insert the DHW temperature sensor bulb into the bulb-holder sheath provided in the DHW tank of the BT-DUO buffer tank.
- Connect the BT-DUO tank feed pump to the component connection strip **J2** (**Bbt**; terminals **N** and **7**) (see "Connection Diagram").
- Connect the boiler to the mains power.
- To correctly configure the type of installation you must adjust parameters **P.08** y **P.09** in the "Technician" menu on the control panel. Access parameter **P.08** in the "Technician" menu (see "Technician Menu") and set the value to "**4**". Next, access parameter **P.09** from the same menu and set the value to "**0**".

For the correct hydraulic and electrical installation of a **BT-DUO** buffer tank, carefully follow the instructions in the manual supplied with it.

Once the hydraulic and electrical connection described above has been completed, to adjust and configure the BT-DUO buffer tank operation, carefully read the section "*Operation with a BT-DUO buffer tank*" in this manual.

DualTherm

4 FUEL

4.1 Wooden pellet

The **DualTherm** boiler must be fuelled with **DIN PLUS**-certified wood pellets. The DIN PLUS certificate assures that the fuel's moisture levels and calorific value are ideal for optimum boiler functioning performance. If this requirement is not complied, **DOMUSA TEKNIK**'s guarantee will automatically be null and void.

The following points should be taken into account for correct fuel storage:

- The stored pellets should be kept dry all year round.
- The applicable legislation in each country for correct fuel storage must be complied.

4.2 Firewood

The quality of the firewood is very important in the performance and useful life of the **DualTherm** boiler. The use of different fuels gives rise to different powers and yields.

The firewood moisture must be less than 25%. If the percentage of water in the firewood is too high, the corrosion inside the boiler increases and the boiler performance is reduced. "Green" wood (recently cut) may contain over 50% moisture. Its caloric power is approximately half of that of "seasoned" wood with 15% moisture. The higher moisture of the wood, the slower the combustion and the lower the flame temperature. This abruptly increases the generation of soot and tar.

For proper operation of the **DualTherm** boiler, the maximum firewood length (L) should be less than 50 cm and the maximum diameter (D), 15 cm, the optimal diameter being between 10 cm and 15 cm.

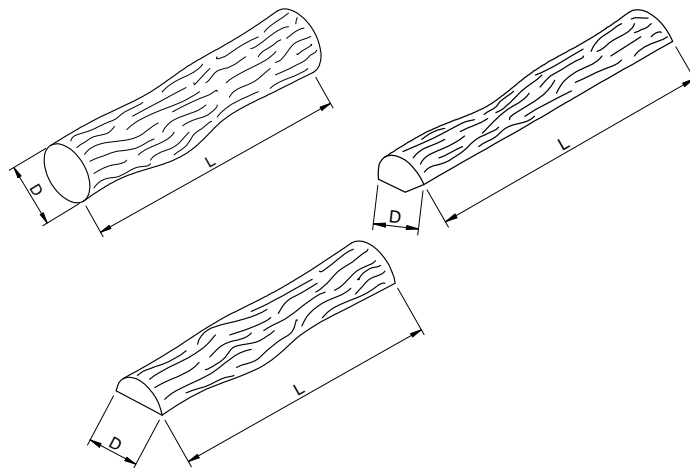

Do not load firewood into the entire combustion chamber. Always leave a space of at least 10 cm to the deflector.

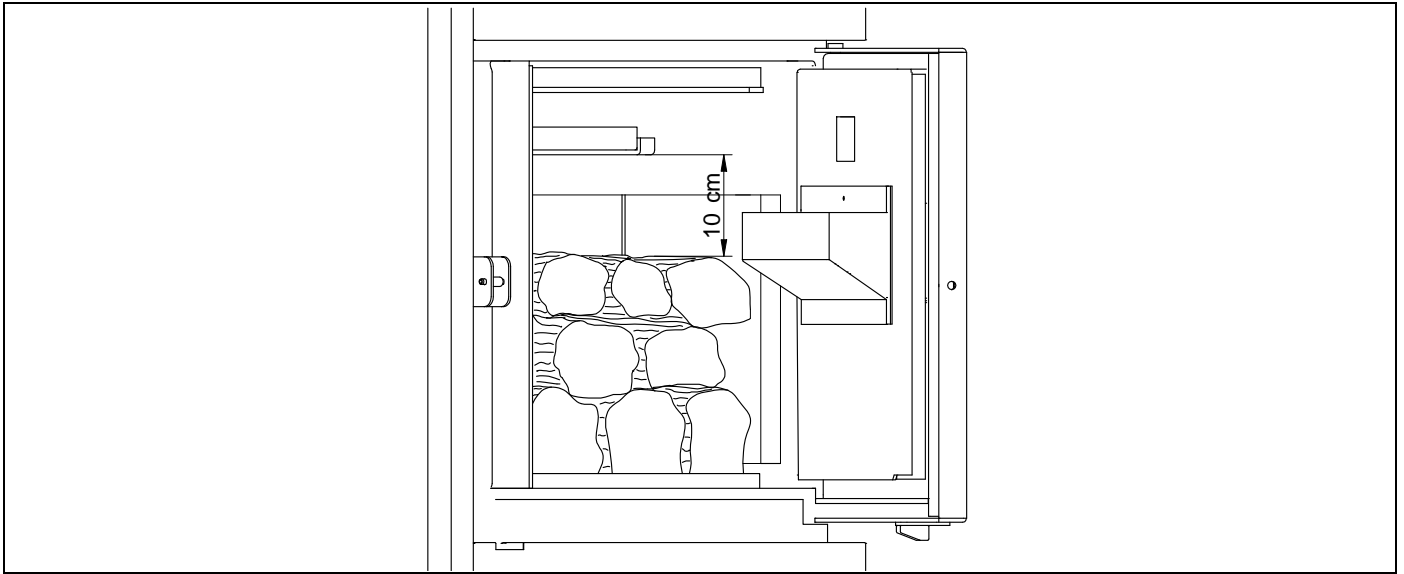

Always put at least four logs at a time. It is advisable to add small wooden slats when using large firewood logs and/or with more moisture. Put at least one of those logs over the burner.

IMPORTANT: Leave spaces between the logs, as this will allow air circulation and, therefore, a faster and more powerful ignition and combustion.

4.3 Unsuitable fuel

- Wood with >25% moisture.
- Waste, plastics
- Paper and cardboard (only for manual ignition).
- Sawdust, wood shavings and/or small wood chips.
- Wood containing nail, staples or any other metal parts
- Coal.
- Generally forbidden by legislation regarding atmospheric contamination and air quality, such as beams, treated wood, plywood, etc.

5 COMMISSIONING OF THE BOILER

5.1 Prior warnings

Repair and maintenance of the boiler must be carried out by a qualified professional, authorised by **DOMUSA TEKNIK**. For optimum functioning and conservation of the boiler, it should be serviced annually.

Carefully read this instruction manual and keep it in a safe, easily-accessible place. **DOMUSA TEKNIK** will not be liable for any damages caused by failure to follow these instructions.

Before any servicing, **disconnect the boiler from the mains**.

5.2 Electrical Connection

It is recommended to install a bipolar switch close to the boiler in order to interrupt the electricity supply to the boiler during maintenance.

5.3 Filling the installation

The hydraulic installation must include a filling valve, drain valves and the necessary hydraulic components for correctly filling the installation.

To fill the installation, open the filling valve until the parameter "*Water pressure*" of "*User Menu*" shows a pressure of 1 - 1.5 bars. The installation must be filled slowly, bleeding the air from the water circuit using the drain valves provided on the same. Close the filling valve after filling.

DualTherm boilers have a pressure sensor for controlling the pressure of the installation. If the installation does not have the minimum pressure set at **P.19** parameter of "*Technical Menu*" (by default 0.5 bar), a low pressure alarm will appear ("**E-19**").

IMPORTANT: Switching on the boiler with no water inside could result in serious damage.

5.4 Initial calibration of the feed auger

The **DualTherm** boiler is supplied from the factory with an auger, which should be assembled inside the hopper, as indicated in section "*Auger*". Due to the diversity of fuel qualities on the market, it will be essential to carry out at least an initial calibration of the feeder for optimal operation of the boiler.

During the commissioning, after filling the installation, alarm ("**E-25**") code is displayed. It isn't possible to switch on the boiler before calibrating the feed auger. Follow the instructions described in "*Feed auger calibration*" section of "*Setup menu*" to assure a correct calibration. Once the calibration is finished, alarm ("**E-25**") would disappear and it will be possible to switch on the boiler.

5.5 Commissioning

In order for the **guarantee to be valid**, the boiler must be commissioned by **personnel authorised by DOMUSA TEKNIK**. Before beginning the commissioning, the following must be complied with:

- The boiler must be plugged in to the mains.
- The installation must be filled with water (the pressure must be between 1 and 1.5 bar).
- The hopper must be filled with fuel.
- None of the wires or hoses should be in contact with a hot surface such as the heat exchanger.

The commissioning sequence is as follows:

- Check if the flue is correctly installed using a condensation inspection tap and a draught stabiliser.
- Check the hopper and the feed auger are correctly installed. **The feed auger must be calibrated for a correct boiler performance** (See *"Calibrating the feed auger"*). Check the right type of fuel is being used (wood pellet must be **DIN PLUS**).
- If the installation has flow and return valves, check they are open.

5.6 Explanation to final user

After commissioning, the Technical Assistance Service will explain to the user how the boiler works, making any observations they consider relevant.

The installer is responsible for clearly explaining to the user the functioning of any control or regulation device forming part of the installation but not supplied with the boiler.

DualTherm

6 DIGITAL DISPLAY

DualTherm boiler is equipped with a digital touch display for viewing and adjustment of the different boiler settings. The display has various display areas where different icons and numbers appear to indicate the different status of the boiler.

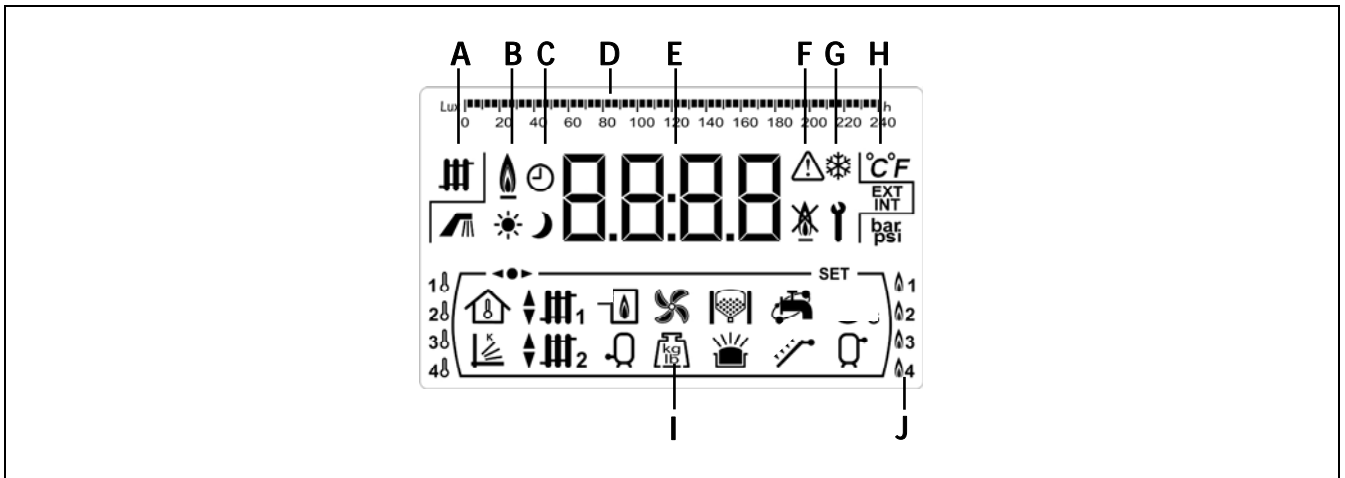



A Boiler status:  Heating function enabled.
 DHW production enabled.

B Icon for flame detection:  Flame detected.

C Timer icons:

 It is displayed when the real time is inside "ON" programmed period.

 It is displayed when actual time is inside "OFF" programmed period.

 When any screen is displayed it relates to the display of actual time, programming, etc.

D Scale marking bar: The meaning can change depending on the parameter displayed:



Time scale: Used to indicate values or settings related to the time and/or time programming:



Lux scale: Used to indicate the lux level read by the flame sensor:



E Numerical digits.

F Alarm icons:  Warning.
 Boiler lock-out.

G Special functions icons:

 **Anti-frost function:** This icon blinks when the boiler's anti-frost function is activated.

 **Technical icon:** It is displayed when any of the boiler's technical parameter on the "Technical Menu" or "Setup menu" is displaying or modifying.

H Auxiliary icons.

- °C Value or setting related to a temperature is shown by the numerical digits.
- EXT Value or setting related to the outside temperature is shown by the numerical digits.
- INT Value or setting related to the room temperature are shown by the numerical digits.
- bar Value or setting related to the boiler water pressure is shown by the numerical digits.

I Operating mode icons:

 It is displayed when a value or setting related to the room temperature or room thermostat or remote controls is shown by the numerical digits.

 It is displayed when a value or setting related to OTC operating mode is shown by the numerical digits.

 It is displayed when the direct heating circuit n° 1 demand is activated or when a value or setting related to this circuit is shown by the numerical digits.

 It is displayed when the direct heating circuit n° 2 demand is activated or when a value or setting related to this circuit is shown by the numerical digits.

 It is displayed when the mixing heating circuit n° 1 demand is activated or when a value or setting related to this circuit is shown by the numerical digits. The arrows appear according to the 3 way mixing valve of the circuit activation mode. The upper arrow indicates that the hot channel of the valve is opening, and the lower arrow indicates that the hot channel of the valve is closing.

 It is displayed when the mixing heating circuit n° 2 demand is activated or when a value or setting related to this circuit is shown by the numerical digits. The arrows appear according to the 3 way mixing valve of the circuit activation mode. The upper arrow indicates that the hot channel of the valve is opening, and the lower arrow indicates that the hot channel of the valve is closing.

 It is displayed when any value or setting **related to the boiler and/or the burner** is shown by the numerical digits.

 It is displayed when a value or setting related to DHW tank is shown by the numerical digits.

 It is displayed when a value or setting related to boiler's fan is shown by the numerical digits.





 It is displayed when a value or setting related to weight, calibration, fuel consumption, etc. is shown by the numerical digits.

 It is displayed when a value or setting related to the **CVS Suction System** is shown by the numerical digits.





 Display of any value or parameter related to the wood burning furnace.

 Display of any value or parameter related to the firewood load in the wood burning furnace.

DualTherm

-  It is displayed when a value or setting related to DHW recirculation function is shown by the numerical digits. It displays blinking when the DHW recirculation pump is switched on.
-  It is displayed when the feed auger is switched on and it is displayed blinking when it is in manual operation mode.
-  Display of any value or parameter related to the temperature or operation of the buffer tank.
-  It is displayed when any of the "Menu" is in browse mode.
- SET** It is displayed when the parameter shown by the numerical digits is adjustable and it is displayed blinking when the parameter is in adjustment mode.

J Combustion Mode Icons:

-  **1** Mode 1 (Pellet only).
-  **2** Mode 2 (Combined).
-  **3** Mode 3 (Automatic firewood).
-  **4** Mode 4 (Manual firewood)

7 COMBUSTION MODES

The **DualTherm** boiler is an automatic pellet boiler with the option of manually loading the firewood. The firewood load should be carried out in the burning furnace, which has a water-cooled grill.

The **DualTherm** boiler provides great versatility thanks to its different burning mode. Up to 4 Combustion Modes can be selected:

Mode 1 (Pellet only). The boiler operates exclusively with wooden pellets.



Mode 2 (Combined). The boiler combines operation with pellets and firewood. The boiler turns on automatically when there is a heat demand. If there is a firewood load, it automatically lights up with the pellet burner. Once the firewood load is fired, the pellet burner turns off. When the firewood load is depleted, in case the heat demand persists, the pellet burner starts automatically to continue to provide heat depending on the needs of the home.

Mode 3 (Automatic firewood). The boiler operates with firewood and uses the pellets exclusively for ignition. When there is heat demand, the firewood load will be turned on automatically by the pellet burner. After automatic detection of the firewood, the pellet burner turns off. Once the firewood is consumed, if there is still a heat demand, the pellet burner will not turn on.

Mode 4 (Manual firewood). The boiler will only operate with firewood. The firewood will light up manually. Once the wood load is consumed, the boiler will remain off until the wood is reloaded.

The DualTherm boiler is factory-set to operate in Mode 2.

7.1 Selecting and Changing Combustion Modes

The selection of the desired Combustion Mode is done through the "**Settings Menu**". To access the "**Settings Menu**", press the symbol . Using the symbols "+" or "-" for Heating (18), you can browse through the menu settings. Once the selection parameter of the Combustion Mode is selected, press  again to access it and perform any adjustments or modifications. To select the desired Operation Mode, touch the "+" or "-" symbols to increase or decrease the value of the Combustion Mode, respectively.

Once the desired parameter has been adjusted, press  again to save and return to the "**Settings Menu**". From the "**Settings menu**" or any of its settings, press Reset to return to the previous display level without saving.

Once the combustion mode is selected, the Combustion Mode change process will start. During this process, the symbols of both Combustion Modes will be displayed until the change is effective.

7.2 Mode 1 (Pellet only)

In this Combustion Mode, the boiler works exclusively with pellets and NO firewood should be loaded into the combustion furnace. The boiler automatically lights up when there is a heat demand and adjusts itself to the needs of the home.



When the boiler temperature exceeds 70°C, the boiler pump (BC) will be activated to distribute the hot water through the installation or, in the case of a buffer, the buffer load pump (Bbt) will be activated to load the buffer. The modulation pellet burner of the **DualTherm** will maintain the installation at the required temperature. When the temperature in the installation exceeds the boiler set-point temperature by 4°C, the burner will shut off until the boiler temperature drops to 10°C below the desired temperature, starting again a new heating cycle.

The operation of the boiler with a buffer is described in further detail in section "*Installation with a buffer*" of this manual.

DualTherm

7.3 Mode 2 (Combined Mode)



In this Combustion Mode, the boiler combines operation with pellets and firewood.

The boiler automatically lights up the pellet burner when there is a heat demand. If there is a firewood load in the burning furnace, it will automatically light up with the pellet burner. Once the firewood load is fired, the pellet burner turns off. When the firewood load is depleted, the screen displays the symbols  and  and begin flashing. In the event that the heat demand persists, the pellet burner will start automatically to continue to supply heat depending on the needs of the home.



When there is no firewood in the burning furnace, the modulation pellet burner of the **DualTherm** boiler will maintain the installation at the required temperature. When the temperature in the installation exceeds the boiler set-point temperature by 4°C, the burner will shut off until the boiler temperature drops to 10°C below the desired temperature, starting again a new heating cycle. When the boiler temperature exceeds 70°C, the boiler pump (**BC**) will be activated to distribute the hot water through the installation or, in the case of a buffer, the buffer load pump (**Bbt**) will be activated to load the buffer. The operation of the boiler with an buffer is described in further detail in section "*Installation with a buffer*" of this manual.

In the event that any firewood load is fired in the furnace, the **DualTherm** boiler will maintain the installation in the required installation through the fan modulation. When the temperature in the installation exceeds the boiler set-point temperature by 6°C, the fan will shut off until its temperature drops to 2°C below the desired temperature. When the boiler temperature exceeds 70°C, the boiler pump (**BC**) will be activated to distribute the hot water through the installation or, in the case of an buffer, the buffer load pump (**Bbt**) will be activated to load the buffer. This pump will remain on whenever any firewood is fired in the furnace. The operation of the boiler with a buffer is described in further detail in section "*Installation with a buffer*" of this manual.

To reduce pellet consumption in the process of firing the firewood, open the door, add the entire firewood load and close the door. Avoid opening and closing the door during the firing process. If any firewood load is fired, you can add another load without having to start the pellet burner. To reload the firewood, slowly open the door to prevent smoke from escaping, insert the firewood and close the door.

IMPORTANT: Whenever you load firewood, make sure that the door properly has been properly closed. When the door is open, the screen displays the symbols  and , which begin flashing.



IMPORTANT: For safety reasons, the door must remain closed during operation and periods of use. Open only to proceed with the loading of firewood.

NOTE: During the firewood firing process, the screen displays the symbols  and , which begin flashing. The firing process can last approximately 30 minutes. Avoid reloading firewood during this period.

NOTE: For automatic firing of the firewood, check that there are pellets in the reserve tank.

7.4 Mode 3 (Automatic firewood)



In this Combustion Mode, the boiler operates with firewood and uses the pellet exclusively for its automatic firing.

When the firewood furnace door is opened and closed, the pellet burner is activated to fire the firewood whenever there is a heat demand. Once the firewood load is fired, the pellet burner turns off. When the firewood load is depleted, the screen displays the symbols  and  are displayed and begin flashing. In the event that the heat demand persists, the pellet burner will not turn on until there is another opening and closing of the door.



If any firewood load is fired in the furnace, the **DualTherm** boiler will maintain the installation in the required installation through the fan modulation. When the temperature in the installation exceeds the boiler set-point temperature by 6°C, the fan will shut off until its temperature drops to 2°C below the desired temperature. When the boiler temperature exceeds 70°C, the boiler pump (**BC**) will be activated to distribute the hot water through the installation or, in the case of a buffer, the buffer load pump (**Bbt**) will be activated to load the buffer. This pump will remain on whenever any firewood is fired in the furnace. The operation of the boiler with a buffer is described in further detail in section "*Installation with a buffer*" of this manual.

To reduce pellet consumption in the process of firing the firewood, open the door, add the entire firewood load and close the door. Avoid opening and closing the door during the firing process.

If any firewood load is fired, you can add another load without having to fire it. To reload the firewood, slowly open the door to prevent smoke from escaping, insert the firewood and close the door.

IMPORTANT: Whenever you load firewood, make sure that the door properly has been properly closed. When the door is open, the screen displays the symbols  and , which begin flashing.

IMPORTANT: For safety reasons, the door must remain closed during operation and periods of use. Open only to proceed with the loading of firewood.

NOTE: During the firewood firing process, the screen displays the symbols  and , which begin flashing. Avoid reloading firewood during this period.

NOTE: For automatic firing of the firewood, check that there are pellets in the reserve tank.

DualTherm



7.5 Mode 4 (Manual firewood)

In this Combustion Mode, the boiler operates exclusively with firewood. The firewood should be fired manually. Once the firewood is consumed, the boiler will remain off until the wood is reloaded.



The ignition process is manual and should be performed as follows:



- Load the burning furnace with firewood. Add a small lumber slats or other ignition media as ignition pads.
- Light a paper ball using a match or a lighter.
- The lit paper is placed with the added material to facilitate the ignition of the firewood (slats, etc.). The door can be kept slightly open to ease ignition.
- Close the door. The control automatically regulates the combustion process.

If any firewood load is fired in the furnace, the **DualTherm** boiler will maintain the installation in the required installation through the fan modulation. When the temperature in the installation exceeds the boiler set-point temperature by 6°C, the fan will shut off until its temperature drops to 2°C below the desired temperature. When the boiler temperature exceeds 70°C, the boiler pump (**BC**) will be activated to distribute the hot water through the installation or, in the case of a buffer, the buffer load pump (**Bbt**) will be activated to load the buffer. This pump will remain on whenever any firewood is fired in the furnace. The operation of the boiler with a buffer is described in further detail in section "*Installation with a buffer*" of this manual.



During the firewood firing process, the screen displays the symbols  and , which begin flashing.

If any firewood load is fired, you can add another load without having to start the pellet burner. To reload the firewood, slowly open the door to prevent smoke from escaping, insert the firewood and close the door.

When the firewood load is depleted, the screen displays the symbols  and , which begin flashing.

IMPORTANT: Whenever you load firewood, make sure that the door properly has been properly closed. When the door is open, the screen displays the symbols  and , which begin flashing.

IMPORTANT: For safety reasons, the door must remain closed during operation and periods of use. Open only to proceed with the loading of firewood.

NOTE: During the firewood firing process, the screen displays the symbols  and , which begin flashing.

8 OPERATION

DualTherm is set by default as an "Only Heating" boiler. In option, it is possible to connect a DHW tank (**Sanit**) and/or a **BT buffer tank** and/or a **BT DUO tank** and/or a **BIO Hydraulic Kit** to increase the features offered.

8.1 "Only heating" operation

In this operation mode, it is needed to set a temperature of the boiler (see "*Boiler temperature set point selection*"), of the room thermostat (**TA1**) or of the **LAGO FB OT+** remote control (if there is any connected) in order to start the boiler up.

It is possible to disable the heating service (**Summer** mode) by setting to "**oFF**" the boiler temperature set point. In this operating mode only the DHW service is available if there is a DHW tank installed.

NOTE: When the heating service is disabled, they will be disabled all the circuits of the BIO Hydraulic Kit, if there is any connected.

8.2 Operating with a Sanit DHW tank (Option)

DualTherm boiler could be installed together with a DHW tank **Sanit**, within the product range offered by **DOMUSA TEKNIK**, to obtain Domestic Hot Water service. Follow the instructions described in section "*Installing a Sanit hot water tank*" to assure a correct installation.

In this operating mode, it is needed to set a DHW temperature set point (see "*DHW temperature set point selection*") in order to start DHW service up. The burner will start running and the DHW pump or valve will switch on if the boiler's temperature overtakes 70 °C and it is higher than the one into DHW tank. When DHW tank temperature reaches the set point temperature, after a period of time (parameter **P.16** of "Technical Menu"), the boiler will be able to heat the heating installation by switching on the heating pump. The burner modulates the heat output level to maintain the boiler temperature set point. The heating pump will stop when the room temperature reaches the set point set at the room thermostat or remote control (if there is any connected).

It is possible to disable the DHW by setting to "**oFF**" the DHW temperature set point.

NOTE: To assure the optimal DHW service, the heating service will not be available while the DHW service is activated to heat the DHW tank.

DualTherm

8.3 Boiler temperature set point selection

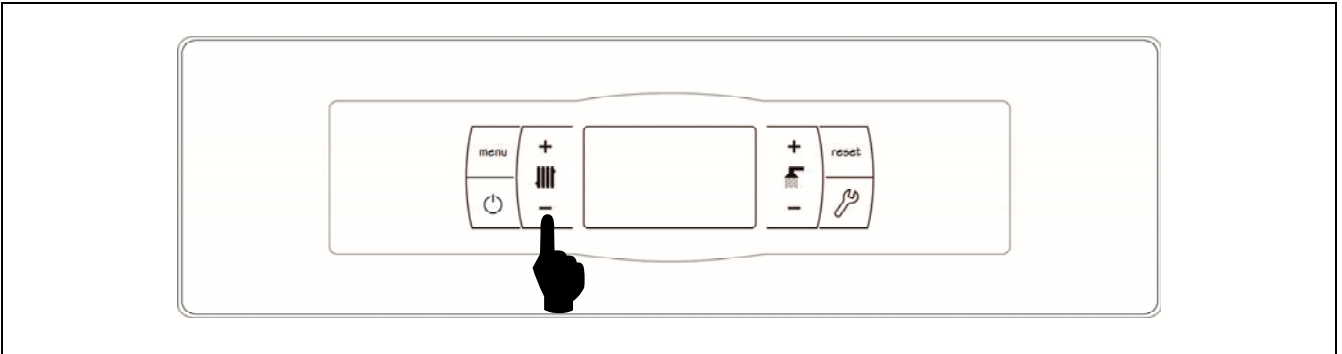

Boiler temperature set point selection is made by the tactile selector shown in the picture. Press "+" and "-" buttons to increase or decrease the set point desired. Few seconds after the desired set point temperature is adjusted the display returns to main position. The range of values for boiler temperature set point is OFF, 75 - 85 °C.

It is also possible to set boiler temperature set point browsing through the "User Menu" by pressing **MENU** button. When parameter "Boiler set point temperature" is displayed, the boiler temperature set point is set by pressing "+" and "-" buttons.

When the "OTC operating mode" is activated by means of **P.10** parameter of "Technical Menu" and the K-factor is set for the heating circuit of the boiler (or direct heating circuit of **BIO Hydraulic Kit**), the boiler temperature set point is calculated depending on the K-factor selected. It is possible to disable the heating service of the boiler (**Summer** mode) by setting to "OFF" the boiler temperature set point by pressing "-" symbol for heating.

8.4 DHW temperature set point selection (with DHW tank installed only)

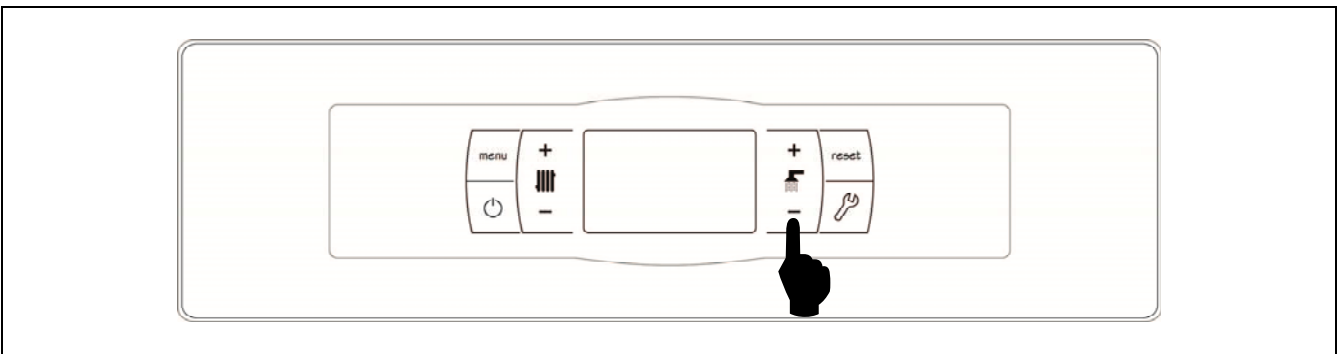

DHW temperature set point selection is made by the tactile selector shown in the picture. Press "+" and "-" buttons to increase or decrease the set point desired. Few seconds after the desired set point temperature is adjusted the display returns to main position. The range of values for DHW temperature set point is OFF, 15 - 65 °C.

It is also possible to set the DHW temperature set point browsing through the "User Menu" by pressing **MENU** button. When parameter "DHW temperature set point" is displayed, the DHW temperature set point is set by pressing "+" and "-" buttons.

It is possible to disable the DHW service by setting to "OFF" the DHW temperature set point by pressing "-" for DHW

8.5 Selecting the set point temperature of the buffer tank (only with buffer tank)

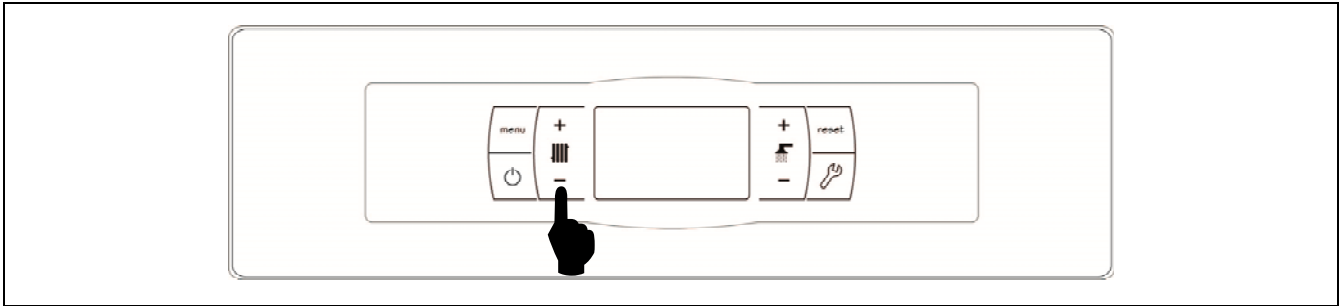

The desired buffer tank temperature is selected using the touch button, as shown in the figure. To select the desired temperature, touch the "+" or "-" symbols to increase or decrease the temperature. When the temperature has been selected, the display will return to standby mode after a few seconds. The permitted range of set point temperature is OFF, 30 - 80 °C.

The buffer tank set point temperature can also be selected by using the touch button MENU to browse to the display option "Buffer tank set point temperature". When this option appears on the display, touch the "+" or "-" symbols to select the desired temperature.

If you wish to totally disable the central heating function of the installation (**Summer** mode), select the set point value "OFF", by touching the "-" symbol until this value appears on the display.

8.6 Functioning according to Outdoor Temperature Conditions OTC (option)

When the boiler is installed together with a **BIO Hydraulic Kit** and an outdoor temperature sensor AFS is connected in the Kit, the OTC operation mode could be activated by means of **P.10** parameter at the "Technical Menu".

When this operation mode is activated, the boiler and/or heating flow temperature are automatically adjusted in accordance with the K-factor curve set at the "Technical Menu" (parameters **P.11** and **P.12**) and the outdoor temperature measured by the outdoor sensor. If the installation is correctly dimensioned, the boiler temperature and/or flow temperature calculated will ensure the room temperature set point set at room thermostat or remote control (if there is any connected).

The K-factor curve relates the outdoor temperature, measured by the sensor installed outside the building, with the boiler temperature set point. The diagram shows the temperature value for each point on the K-factor curve.

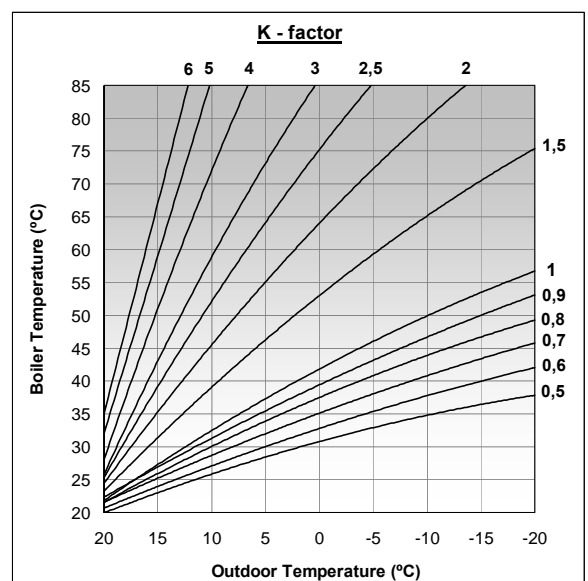

Depending on the type of heating circuit, isolation of the building and position of the outdoor sensor, the optimal K-factor curve could be different. Nevertheless, a general rule could be that for high temperature heating circuits (radiators heating circuit) the K-factor curve should be 1 or higher and for low temperature heating circuits (under floor heating circuit) it should be 0.8 or less.

IMPORTANT: To connect the outdoor sensor AFS to BIO Hydraulic Kit, follow the connection instructions provided within the Kit.

DualTherm

9 OPERATING WITH BIO HYDRAULIC KITS (OPTIONAL)

All models in the **DualTherm** boiler line can be connected to a kit of the **BIO Hydraulic Kit** line to manage more than one heating circuit, always accompanied by a buffer between the boiler and the heating system. Up to 3 heating circuits and a DHW circuit can be managed depending on the **BIO Hydraulic Kit** chosen. For a detailed description of the functioning of the Kit, read the manual supplied within the Kit. Nevertheless the following guidelines are given:

Operation of direct heating circuit

When the **BIO Hydraulic Kit** installed has a direct circuit pump (**Bcd**), its **mode** of operation can be selected through parameter **P.23** of the "*Technical Menu*" of the boiler:

P.23 = 0 => Operation as a heating circulation pump (default value).

P.23 = 1 => Operation as a DHW accumulator load pump.

When the direct circuit pump is configured for heating circuit operation mode (**P.23 = 0**), this circuit will operate with the set-point temperature of the selected buffer and the temperature of the room thermostat **TA₁** or a LAGO FB OT+ remote control, both connected to the terminal strip of the boiler (see "*Connections diagram*"). When the **BIO Hydraulic Kit** is operating with an outdoor temperature sensor, by means of parameter **P.10** OTC operation mode (Outdoor Temperature Control) may be selected for the direct circuit. OTC mode allows the boiler temperature setting depending on the K-factor curve set at **P.12** parameter and the actual outdoor temperature read by the sensor.

When the direct circuit pump is configured as a DHW tank charging pump (**P.23 = 1**), the direct circuit will work according to the DHW temperature set point selected on the boiler main board and the temperature read by the DHW sensor **Sa** installed into the tank.

In both cases, the burner and circulating pump will start operating (**Bcd** of the **BIO Hydraulic Kit**) until the temperature set point is reached in the boiler or in the DHW storage tank.

Mixing circuit n° 1 functioning

The mixing heating circuit No 1 will work together with the flow temperature set point adjusted for circuit No 1 and the temperature of the room thermostat or LAGO FB OT+ remote control connected in the **BIO Hydraulic Kit** (see "*Connection diagram*" of the **BIO Hydraulic Kit** instructions manual). When the **BIO Hydraulic Kit** is operating with an outdoor temperature sensor, by means of parameter **P.10** OTC operation mode (Outdoor Temperature Control) may be selected for the direct circuit. OTC mode allows the boiler temperature setting depending on the K-factor curve set at **P.11** parameter and the actual outdoor temperature read by the sensor.

Mixing circuit n° 2 functioning

The mixing heating circuit No 2 will work together with the flow temperature set point adjusted for circuit No 2 and the temperature of the room thermostat or LAGO FB OT+ remote control connected in the **BIO Hydraulic Kit** (see "*Connection diagram*" of the **BIO Hydraulic Kit** instructions manual). When the **BIO Hydraulic Kit** is operating with an outdoor temperature sensor, by means of parameter **P.10** OTC operation mode (Outdoor Temperature Control) may be selected for the direct circuit. OTC mode allows the boiler temperature setting depending on the K-factor curve set at **P.12** parameter and the actual outdoor temperature read by the sensor.

10 OPERATION WITH A BT BUFFER TANK

The **DualTherm** boiler can be accompanied by a **BT Buffer tank** from the wide range of tanks offered by **DOMUSA TEKNIK**. This tank accumulates heat energy that improves the performance of the system when switching the boiler on and off. For its correct installation, carefully follow the assembly instructions included with the tank and for its correct integration with the **DualTherm** boiler, read the instructions in the section "*Installing a BT Buffer tank*" in this manual.

The electronic control of the **DualTherm** boiler is able to manage four different installation configurations of the BT buffer tank. Depending on the configuration of the installation (parameter **P.08** in the "Technician" menu) there are 2 operating modes:

10.1 Operation with a temperature sensor in the BT buffer tank (P.08 = 1 or 2)

In this operating mode you must select the desired set point temperature of the buffer tank (*see "Selecting the buffer tank set point temperature"*) and the temperature of the room thermostat No. 1 (**TA1**) or remote control **LAGO FB OT+** (if present). The burner will start working to heat the water in the boiler. When the boiler temperature exceeds 70 °C the feed pump for the buffer tank (**Bbt**) will start up to heat the BT tank. When the temperature of the tank reaches the set-point temperature, the pellet burner, or if there is a firewood load, the fan will shut down until its temperature drops to the value set in parameter **P.28** (by default 5 °C) below that desired, once again starting a new heating cycle.

Regarding the central heating service of the boiler, the circulation pump (**BC**) will be activated whenever room thermostat No. 1 (**TA1**), or the remote control **LAGO FB OT+** (if present), demands heating. In other words, when the room temperature where the thermostat or the remote control is installed is lower than that which is set. When the atmosphere reaches the desired temperature and after a time of post-circulation (parameter **P.15** in the "Technician Menu"), the operation of the heating pump (**BC**) will turn off.

The boiler's central heating service can be totally disabled (*Summer* mode) by selecting a buffer tank set point value of "**oFF**". In this operating mode, only the DHW production function will remain enabled, providing there is a DHW tank connected to the tank (**P.08 = 1**) or to the boiler (**P.08 = 2**).

NOTE: When the heating function is disabled, all the circuits of the BIO hydraulic Kit will also be disabled, if connected.

NOTE: This operating mode is only activated when parameter P.08 of the "Technician" menu is set to 1 or 2 and when there is a buffer tank installed.

DualTherm

10.2 Operation with a control thermostat in the BT buffer tank (P.08 = 3 or 4)

In this operating mode you must select the desired set point temperature of the boiler (*see "Selecting the boiler set point temperature"*) and, using the control thermostat installed in the buffer tank, you must also select the desired set point temperature in the buffer tank. **It is essential for the operation of the installation that the set point temperature selected for the boiler exceeds the set point selected for the control thermostat of the buffer tank and it is recommended that it be at least 5 to 10 °C higher.** The DualTherm boiler will start operation to heat its water. When the boiler temperature exceeds 70 °C the feed pump for the buffer tank (**Bbt**) will start up to heat the BT tank, provided that its control thermostat is activated (demanding heating). When the buffer tank thermostat reaches the desired temperature and turns off the heating demand, operation of the buffer tank feed pump (**Bbt**) will be disabled. In the event that there is a firewood load, the operation of the load pump will be activated until it is depleted.

Regarding the central heating service of the boiler, the circulation pump (**BC**) will be activated whenever room thermostat No. 1 (**TA1**), or the remote control **LAGO FB OT+** (if present), demands heating. In other words, when the room temperature where the thermostat or the remote control is installed is lower than that which is set. When the atmosphere reaches the desired temperature and after a time of post-circulation (parameter **P.15** in the "Technician Menu"), the operation of the heating pump (**BC**) will turn off.

The boiler's central heating service can be totally disabled (*Summer* mode) by selecting a boiler setpoint value of "**oFF**". In this operating mode, only the DHW production function will remain enabled, providing there is a DHW tank connected to the tank (**P.08 = 3**) or to the boiler (**P.08 = 4**).

IMPORTANT: It is essential for the operation of the installation that the set point temperature of the boiler exceeds the set point selected for the control thermostat of the buffer tank.

NOTE: When the heating function is disabled, all the circuits of the BIO hydraulic Kit will also be disabled, if connected.

NOTE: This operating mode is only activated when parameter P.08 of the "Technician" menu is set to 3 or 4 and when there is a buffer tank installed.

11 OPERATION WITH A BT-DUO BUFFER TANK (OPTIONAL)

The **DualTherm** boiler can be accompanied by a **BT-DUO Buffer tank** from the wide range of tanks offered by **DOMUSA TEKNIK**. This tank accumulates heat energy that improves the performance of the system when switching the boiler on and off. It also incorporates a DHW cylinder in its interior for obtaining Domestic Hot Water. For its correct installation, carefully follow the assembly instructions included with the tank and for its correct integration with the **DualTherm** boiler, read the instructions in the section "*Installing a BT-DUO Buffer tank*" in this manual.

In this operating mode you must select the desired set point temperature of the boiler (*see "Selecting the boiler set point temperature"*) and, using the adjustment thermostat of the control panel in the BT-DUO buffer tank, you must also select the desired set point temperature in the buffer tank. **It is essential for the operation of the installation that the set point temperature selected for the boiler exceeds the set point selected for the thermostat of the BT-DUO buffer tank and it is recommended that it be at least 5 to 10 °C higher.** The **DualTherm** boiler will start operation to heat its water. When the boiler temperature exceeds 70 °C the feed pump for the buffer tank will start up to heat the BT-DUO tank, provided that its control thermostat is activated (demanding heating). When the BT-DUO tank thermostat reaches the desired temperature and turns off the heating demand, the operation of its feed pump will be disabled. In the event that there is a firewood load, the load pump will be activated until it detects the depletion of the firewood.

Regarding the central heating service of the boiler, the circulation pump connected to it (**BC**) will be activated whenever room thermostat No. 1 (**TA1**), or the remote control **LAGO FB OT+** (if present), demands heating. In other words, when the room temperature where the thermostat or the remote control is installed is lower than that which is set. When the atmosphere reaches the desired temperature and after a time of post-circulation (parameter **P.15** in the "Technician Menu"), the operation of the heating pump (**BC**) will turn off.

Regarding the operation of the service for providing DHW, provided that a DHW temperature sensor is installed in the **BT-DUO** tank, you must select the desired DHW set point temperature (*see "Selecting the DHW set point temperature"*). The heat demand and the **BT-DUO** tank load pump will be activated whenever the water temperature of the boiler exceeds 70 °C. When the tank reaches the DHW set point temperature selected and after a waiting period (parameter **P.16** in the "Technician Menu"), it will once again be available to heat the central heating system, activating the central heating service. In order to provide an optimal production of DHW, while this is active the boiler's central heating service will remain disabled and it will not be restored until it has finished heating the DHW cylinder of the **BT DUO** tank.

The boiler's central heating service can be totally disabled (*Summer* mode) by selecting a boiler set point value of "**oFF**". In this operating mode, only the DHW production function will remain enabled, via the cylinder integrated inside the **BT-DUO** tank. Also, you may totally disable the domestic hot water production function by selecting "**oFF**" as the DHW set point temperature.

IMPORTANT: It is essential that the set point temperature of the boiler exceeds the set point selected for the control thermostat of the buffer tank.

NOTE: When the heating function is disabled, all the circuits of the BIO hydraulic Kit will also be disabled, if connected.

NOTE: For the correct operation of the BT-DUO buffer tank, parameters P.08 and P.09 in the "Technician" menu must be set to 4 and 0 respectively.

12 OPERATING WITH LAGO FB OT+ REMOTE CONTROL (OPTIONAL)

A remote control (**LAGO FB OT+**) can optionally be supplied together with **DualTherm** boiler. This remote control can be used to fully operate the boiler from anywhere in the room in which it is installed. The **LAGO FB OT+** remote control regulates the parameters of heating circuit and the domestic hot water production.

This remote control allows the hours of comfort to be programmed for heating circuit, regulating the installation to the particular requirements of the building by measuring the room temperature and consequently adapting the installation temperature. The remote control can also be used to regulate the hot water and heating temperatures set point at any time, and for viewing the different boiler operation parameters. It also warns of any functioning anomalies affecting the boiler.

The **LAGO FB OT+** remote control may optionally be connected to an outdoor temperature sensor, for measuring the temperature around the building. With this option installed, the remote control can adjust the building comfort level according to the weather conditions, optimising fuel consumption and heating comfort in the building.

The **LAGO FB OT+** remote control takes over the control of the boiler when it is connected. The different selectable temperatures boiler of the boiler must be set at the remote control. It is easy to install, requiring only 2 wires for communication between the boiler and the **LAGO FB OT+** control, by connecting the two wires on terminal strip **J5** (see *"Electrical Connection Diagram"*). For a correct installation and functioning, read carefully the instructions within the remote control.

The following sections contain a general explanation of the different operating modes and options of **LAGO FB OT+** remote control.

Operation of the heating circuit

The maximum temperature for heating circuit, the operating period of time and the desired room temperature can be set at remote control. **LAGO FB OT+** remote control will calculate the boiler temperature required at each particular time, depending on the temperature of the room and it will activate or deactivate the heating demand depending on the heating times and room temperatures programmed.

DHW service function

When **DualTherm** boiler is installed together with a DHW tank the desired DHW temperature and the desired periods of time for DHW service must to be set at **LAGO FB OT+** remote control. **LAGO FB OT+** remote control regulate the DHW tank temperature and enables or disables the DHW service according to the time periods scheduled.

13 USER MENU

"User Menu" shows the settings related to boiler functioning on the digital display.

To access this menu press MENU; press this button repeatedly to browse through the different settings available. When one of the options is displayed, after 20 seconds the display returns to main position. In the following table are listed all the settings of "User Menu":

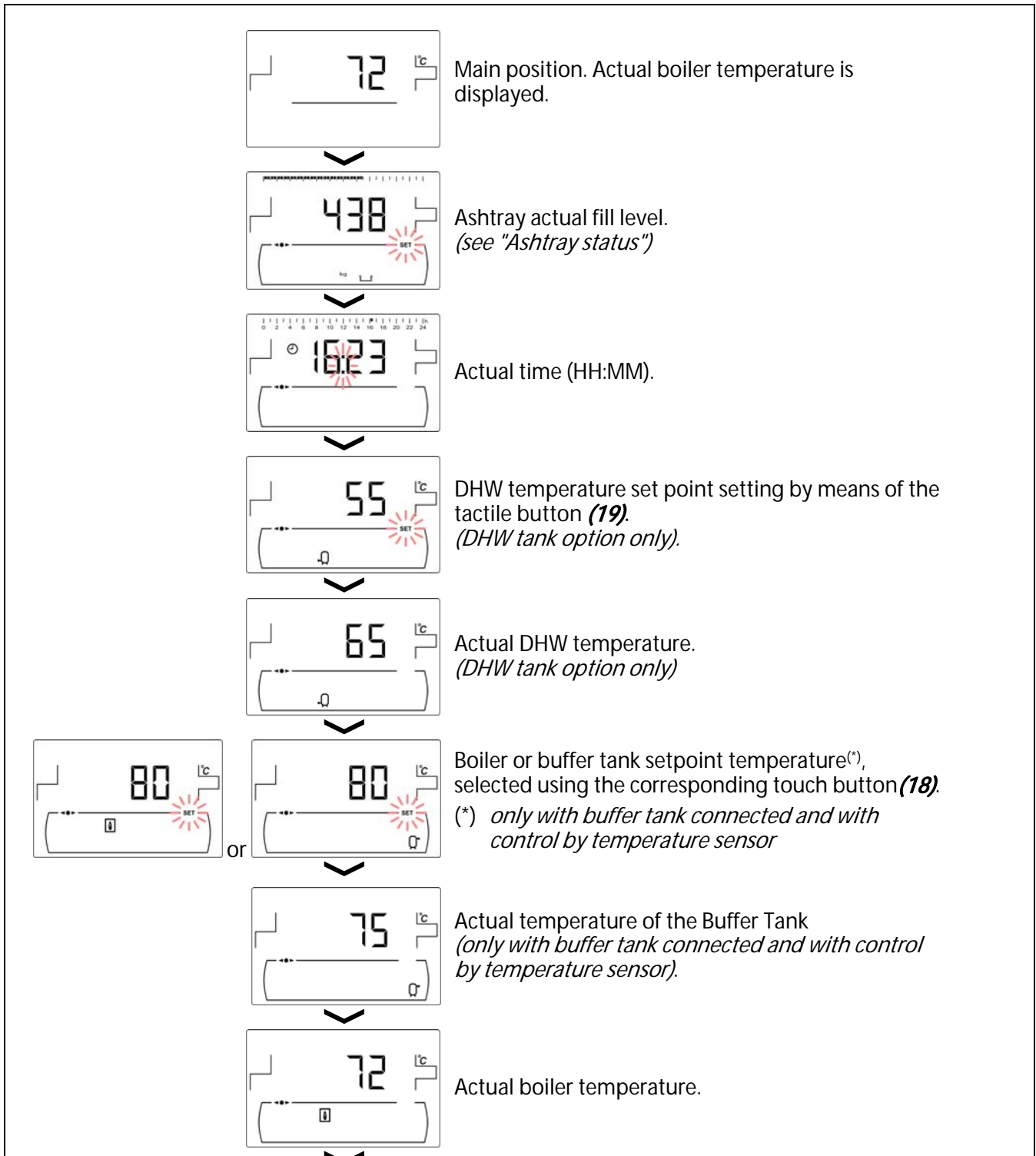

DualTherm

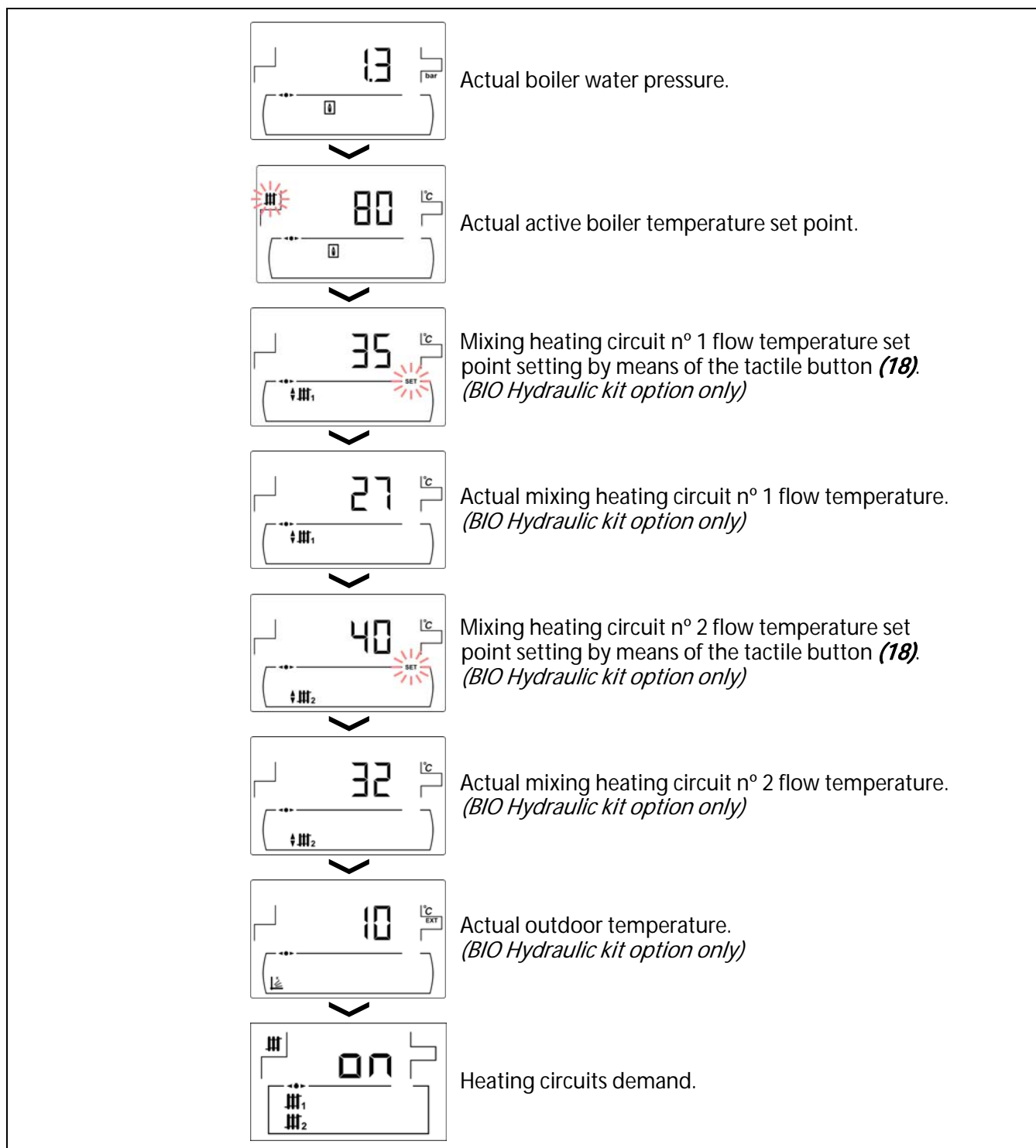

14 SETUP MENU

"Setup menu" consists of operating parameters of the boiler which can be adjusted by the user (Timer programming, time setting, ...)

To access to the "Setup menu" press . Browse through the menu by pressing the symbols "+" or "-" of heating (18). When a parameter is displayed, press to access and set it. When the parameter has been set, press again, the new value will be saved and the display will return to "Setup menu". Press RESET any time to go back without recording any value. In the following table are listed all the parameters of "Setup menu".

Nº.	Parameter	Display
1	Boiler timer programming.	
2	CVS Suction System timer programming. <i>(CVS Suction System option only)</i>	
3	DHW recirculation function timer programming. <i>(DHW tank option only)</i>	
4	Time setting.	
5	Selecting the Combustion Mode.	
6	Manual setting of feed auger calibration.	
7	Screen contrast setting.	

DualTherm

14.1 Timers programming process

DualTherm boiler allows setting 3 different timers: boiler timer, **CVS Suction System** timer (if there is any connected) and DHW recirculation pump timer (if this function is activated on the "Technical Menu"). The default setting for the timers is disabled ("- - - -"), so the functioning that is regulated by each timer will operate 24 hours. The programming process is the same for any timer.

When the desired timer is displayed, press  to access. SET symbol blinks to start the setting process:

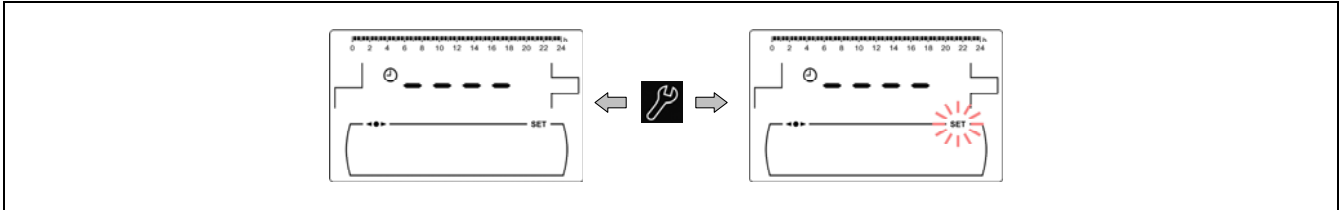

Select the time periods (30 minutes periods) by pressing "+" or "-" of heating (18).

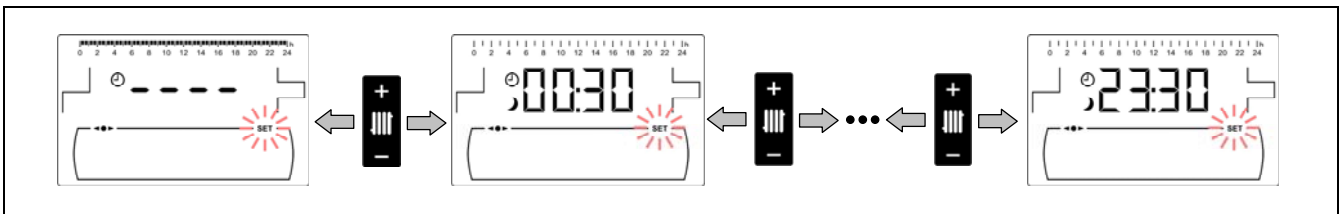

When the period desired is selected, change it state by pressing "+" or "-" of DHW (19). The function will be switched off if symbol ☾ is displayed and it will be switched on if symbol ☀ is displayed.

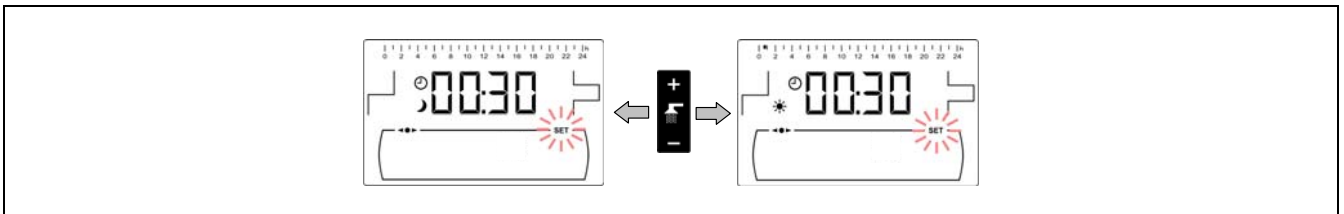

After setting all the periods desired, press  to save and return to "Setup menu" level.

14.2 Boiler timer programming

This timer is used to adjust the switching on and off periods of the boiler functioning. To disable the timer, select boiler timer programming (🔥) and set it to "- - - -" by pressing "-" of the boiler temperature touch button (18). The boiler timer will be cancelled and it will be switched on permanently.

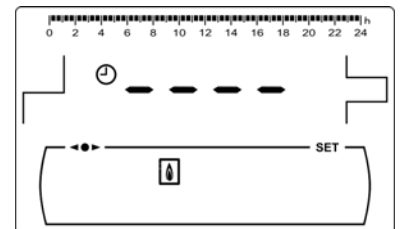

14.3 CVS Suction System timer programming (CVS Suction System option only)

This timer is only displayed when an **CVS Suction System** is connected to the boiler. It is used to adjust the switching on and off periods of the **CVS Suction System** functioning. To disable the timer, select the **CVS Suction System** timer programming (🌊) and set it to "- - - -" by pressing "-" of the boiler temperature touch button (18). Kit timer will be cancelled and it will be switched on

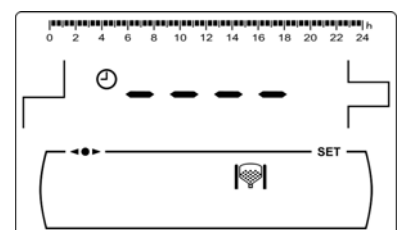

permanently.

14.4 DHW recirculation function timer programming (DHW tank option only)

This timer is only displayed when the DHW recirculation function is selected in the multifunction relay parameter (P.20 = 2) of the "Technical Menu". It is used to adjust the switching on and off periods of DHW recirculation pump. To disable the timer, select the DHW recirculation timer programming (🔧) and set it to "- - - -" by pressing "-" of the boiler temperature touch button (18). The timer will be cancelled and DHW recirculation pump will be switched on permanently.

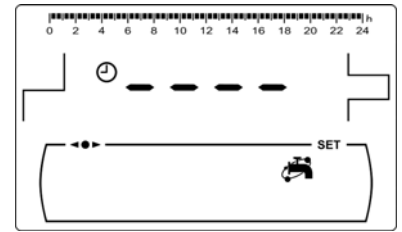

14.5 Time setting

When "Time setting" parameter of "Setup menu" is displayed, press 🔧 to access. The first two digits of numerical digits blinks (hours) and setting process begins:

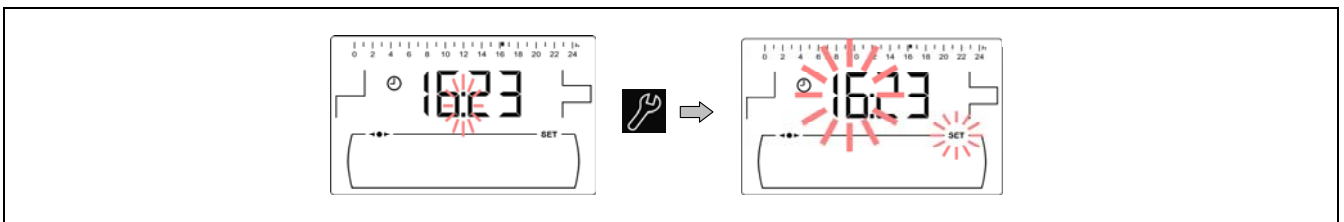

Set the hour value by pressing "+" or "-" of DHW (19). Pressing 🔧 the value is saved and the minutes digits blinks to set them.

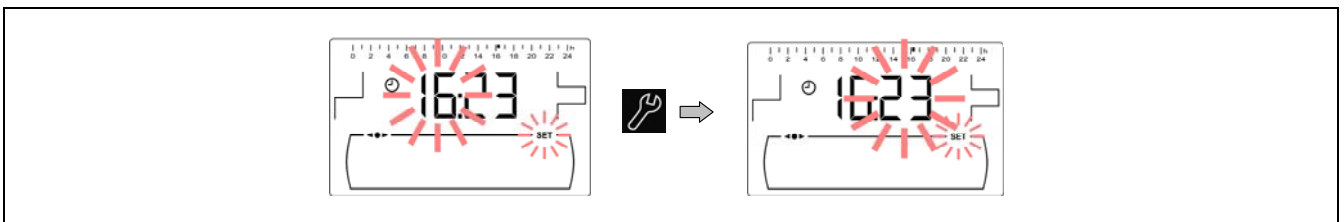

Set the minutes value by pressing "+" or "-" of DHW (19). Pressing 🔧 the value is saved and it returns to "Setup menu" level.

14.6 Manual setting of feed auger calibration

When this parameter is displayed (📊) on "Setup menu", press 🔧 to access and set the value desired by pressing "+" or "-" of DHW (19). The range of values selectable is OFF, 500 – 5.000 g.

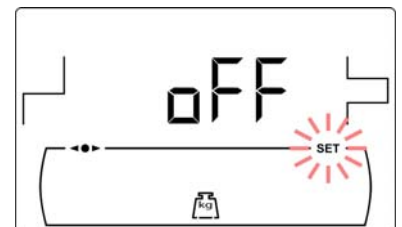



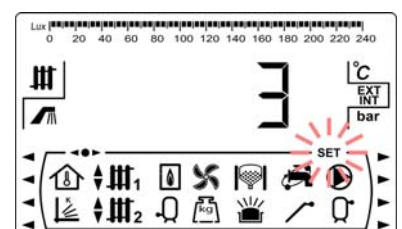

14.7 Screen contrast setting





When this parameter of the "Setup menu" is displayed, press 🔧 to access and set the value desired by pressing "+" or "-" of DHW (19). The range of values selectable is 1 - 5.



15 CALIBRATION MENU

"*Calibration Menu*" consists of a number of processes and parameters that allow the correct set up of the boiler.

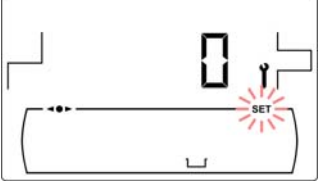
To access the "*Calibration Menu*", the boiler must be switched off by pressing  tactile button. After having switched off the boiler press  for 5 seconds to access to the menu. Browse through the menu by pressing the symbols "+" or "-" of heating (18). When the desired parameter is displayed, press  to access and set it. When the parameter or process has been set, press  again, the value will be saved and the display will return to "*Calibration menu*". Press RESET any time to go back without recording any value. In the following table are listed all the parameters and processes included in "*Calibration menu*".

Nº.	Parameter	Display
1	Feed auger filling	
2	Feed auger calibration	
3	Manual setting of feed auger calibration	
4	Manual ash cleaning activation	
5	Manual circulation pumps activation	

15.1 Feed auger filling

During the commissioning of the boiler, before calibrating the feed auger or if the hopper runs out of fuel, **it is compulsory** to fill of fuel the feed auger. By means of this parameter the feed auger will be filled of fuel, process required for a correct boiler functioning.

When "Feed auger filling" parameter is displayed (🔧) on "Calibration Menu", press 🔧 to access. SET symbol blinks and pressing 🔧 again it will be activated filling procedure. The feed auger will be activated and a count up to 15 minutes (maximum) will be displayed. During the process by pressing 🔧 the feed auger could be stopped at any time and by pressing RESET the filling procedure could be finished and return to "Calibration Menu" at any time.

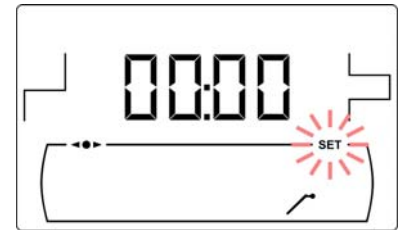

To ensure a complete filling of boiler feed auger it is recommended to make a complete 15 minute procedure of filling, at least once. Follow the steps shown in the following pictures for a correct filling of the feed auger:

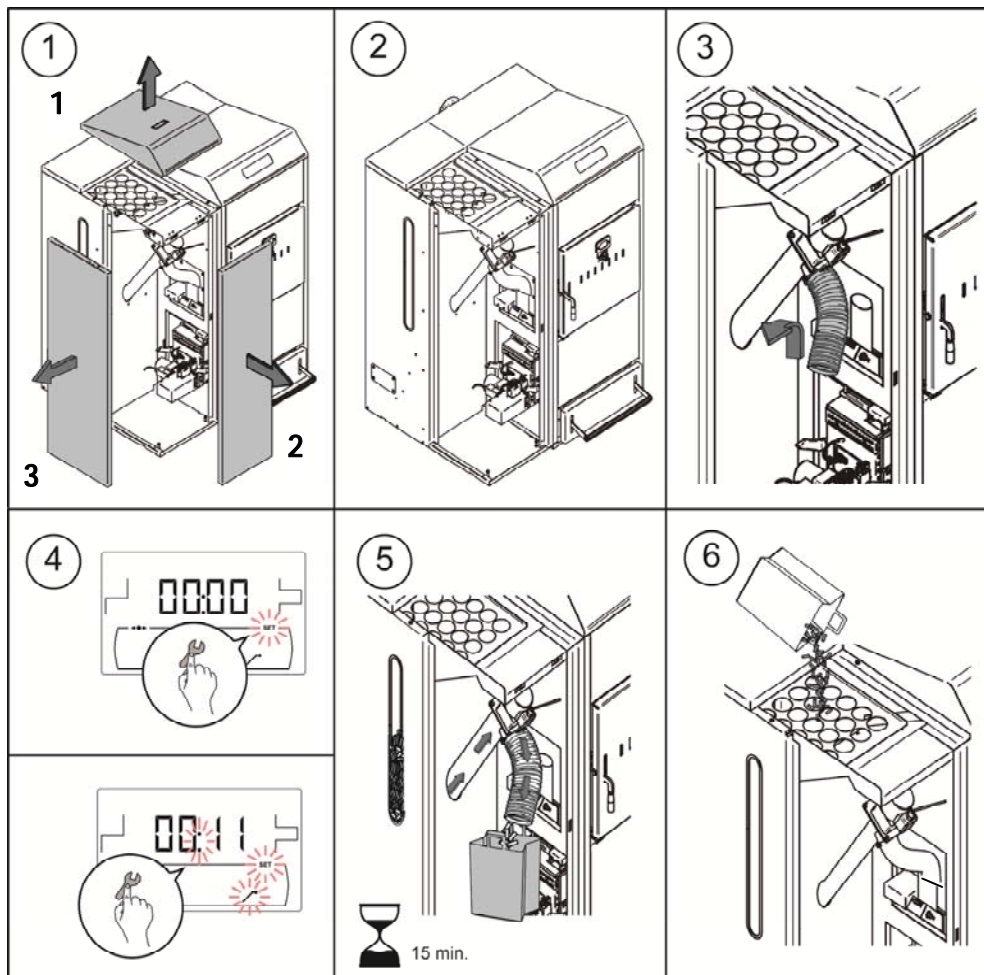

IMPORTANT: It is compulsory to fill the feed auger during the commissioning or when the hopper runs out of fuel.

DualTherm

15.2 Feed auger calibration

By means of calibrating the feed auger the electronic controller of the boiler adjusts the optimum amount of fuel required to supply the burner and to produce the correct heat output and combustion. By means of this parameter the feed auger calibration procedure will be made, process required for a correct boiler functioning. **In any case the hopper is empty or it runs out of fuel, it is compulsory to fill the feed auger before carrying out the calibration process. It is compulsory to calibrate the feed auger on commissioning and whenever the fuel supplier is changed** (not all suppliers provide fuel of the same quality and size).

When "Feed auger calibration" parameter is displayed (🗑️) on "Calibration Menu", press 🔧 to access. SET symbol blinks and pressing 🔧 again it will be activated calibration procedure. The feed auger will be activated and a countdown from 200 doses will begin. When the countdown finishes current calibration value will be displayed, press 🔧 to adjust the new value obtained during the procedure by pressing "+" or "-" symbols of DHW (19). Finally pressing 🔧 the value will be saved and it will return to Calibration Menu level.

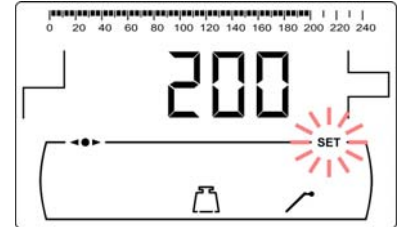

This process must be carried out at least twice to ensure the correct amount of fuel has been added. Follow the steps shown in the following pictures for a correct calibration of the feed auger:

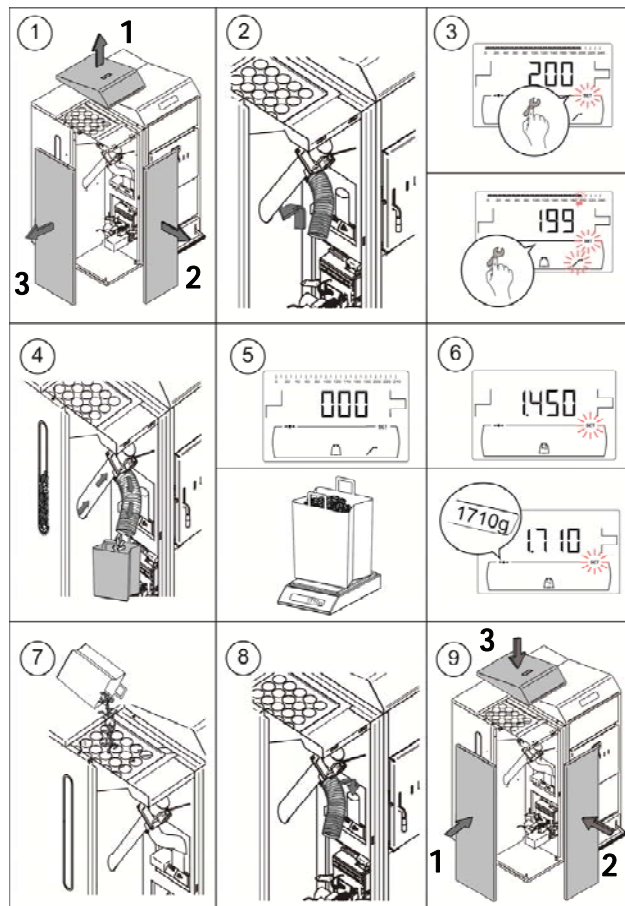



IMPORTANT: Calibrate the feed auger during commissioning of the boiler or whenever the fuel supplier has been changed.

15.3 Manual setting of feed auger calibration

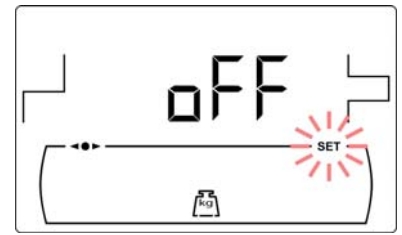
By means of this parameter the weight obtained in the feed auger calibration procedure can be set manually. When "Manual setting of feed auger calibration" parameter is displayed (kg) on "Calibration Menu", press  to access and set the value desired by pressing "+" or "-" of DHW (19). The range of values selectable is OFF, 0.500 - 5.000 g.



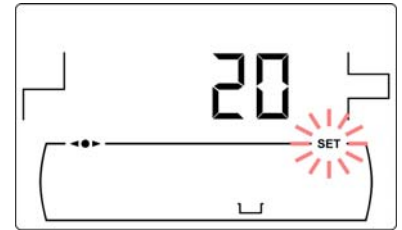

15.4 Manual ash cleaning activation

By means of this parameter the burner ash cleaning device can be switched on manually up to a maximum of 20 cleaning cycles. When "Manual ash cleaning activation" parameter is displayed (□) on "Calibration Menu", press  to access. SET symbol blinks and pressing  again it will be activated the cleaning system. A countdown of 20 cycles will be displayed. When the countdown is finished the cleaning device will stop. By pressing  the cleaning procedure can be stopped at any time and by pressing RESET it will return to "Calibration Menu" level.



15.5 Manual circulation pumps activation



By means of this parameter the circulation pumps can be switched on manually. When "Manual circulation pump activation" parameter is displayed (▶) on "Calibration Menu", press  to access. SET symbol blinks and pressing  again the circulation pumps will be activated for a period of not more than 20 minutes.











By pressing  the circulation pumps can be stopped at any time and by pressing RESET it will return to "Calibration Menu" level.

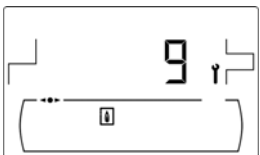

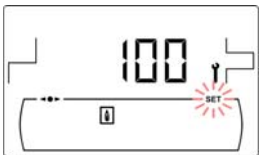



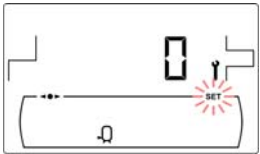

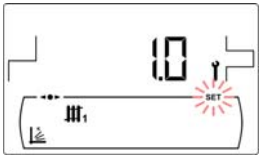
16 TECHNICAL MENU

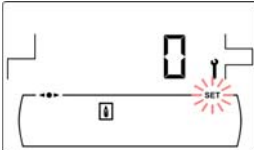
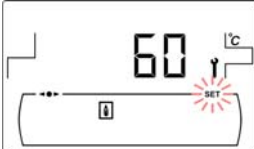
"Technical Menu" consists of a number of technical operating parameters that only have to be modified by a person with sufficient technical knowledge of the meaning of each parameter. Any inappropriate setting of a parameter of "Technical Menu" can cause a serious malfunctioning of the boiler and could cause damages to people, animals or things.

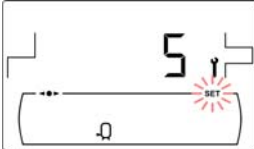

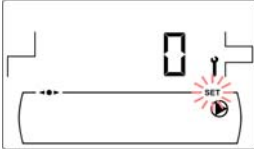

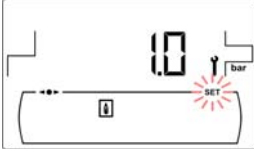

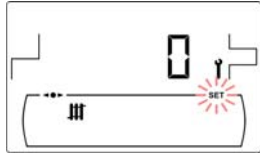

To access the "Technical Menu" press MENU and RESET tactile buttons together for 5 seconds. Access code ("cod") request will be displayed (see "Entry and set the access code"). After entering the correct code, the first parameter of "Technical menu" will be displayed. Browse through the menu (P.01, ..., P.27) by pressing the symbols "+" or "-" of heating (18). When the desired parameter is displayed, press  to access and set it by pressing the symbols "+" or "-" of DHW (19). When the parameter has been set, press  again, the value will be saved and the display will return to "Technical menu". Press RESET any time to go back without recording any value. The following table lists these parameters and they are described in detail in the following sections of the manual:

DualTherm

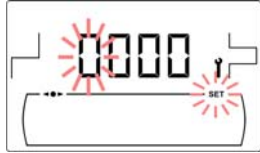
N°	Parameter	Display
Cod	Access code (by default 1234)	
P.01	Boiler model	
P.02	Minimum boiler heat output (%)	
P.03	Maximum boiler heat output (%)	
P.04	General fan speed factor (%)	
P.05	Fuel for ignition (g)	
P.06	Fuel consumption (kg/h)	
P.08	Selecting the type of installation for the BT buffer tank <i>(Only with buffer tank installed)</i>	
P.09	DHW installation mode <i>(DHW tank option only)</i>	
P.10	OTC operating mode <i>(Bio Hydraulic kit option only)</i>	
P.11	Heating circuit n. 1 K-factor curve <i>(Bio Hydraulic kit option only)</i>	

N°	Parameter	Display
P.12	Heating circuit n. 2 K-factor curve <i>(Bio Hydraulic kit option only)</i>	
P.13	Boiler minimum temperature mode	
P.14	Minimum boiler temperature (°C)	
P.15	Heating pump post-circulation time (min)	
P.16	DHW pump post-circulation time (min) <i>(DHW tank option only)</i>	
P.17	Legionella protection function <i>(DHW tank option only)</i>	
P.18	Boiler's pump operating mode (BC)	
P.19	Minimum boiler water pressure (bar)	
P.20	Multifunction relay	
P.21	Automatic water filling pressure(bar) <i>(P.20 = 3 option only)</i>	
P.22	CVS Suction System cycle time (s) <i>(CVS Suction System option only)</i>	

DualTherm

N°	Parameter	Display
P.23	BIO Hydraulic Kit direct pump operating mode <i>(BIO Hydraulic Kit option only)</i>	
P.24	Reset default values	
P.25	Set access code	
P.27	Maximum heating flow temperature of mixed circuits <i>(Only with the optional Hydraulic Kit Bio)</i>	
P.28	BT buffer tank temperature hysteresis <i>(Only with buffer tank installed)</i>	
P.32	Adjusting the power of the pellet burner during firewood firing	
P.33	Minimum firewood combustion power adjustment	
P.34	Fan speed during manual firewood firing	

16.1 Entry and set the access code ("cod", P.25)

When the access code request is displayed or to set a new one (P.25), press  to access. SET symbol blinks and it would be possible to enter the code or set it. Press the "+" o "-" for heating symbols (18) to browse trough the digits and press the "+" o "-" for DHW symbols (19) to set each digit. By default, the access code is "1234". The P.25 parameter allows to set a new access code.

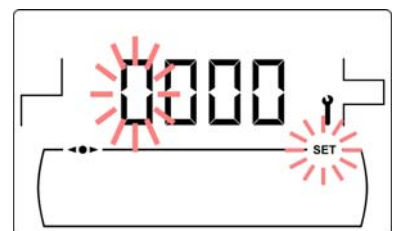

17 BOILER'S SETUP PARAMETERS

The following parameters in the "*Technical Menu*" allow to adjust the boiler to each installation. They only may be modified by a person with sufficient technical knowledge of the meaning of each parameter. Any inappropriate setting of a parameter of "*Technical Menu*" can cause a serious malfunctioning of the boiler and could cause damages to people, animals or things.

17.1 Boiler Model (P.01)

Parameter **P.01** displays the model of the boiler set at DIP-switch on the electronic board.

P.01 = 25 => DualTherm 25

P.01 = 35 => DualTherm 35

17.2 Boiler heat output (P.02, P.03)

The **DualTherm** boiler is configured to modulate the pellet burner power between a minimum and maximum power. By means of parameters **P.02** and **P.03** the minimum and maximum heat output of the burner may be set at desired value. The range of modulation selectable depends on the model of boiler and the type of fuel set.

17.3 General fan speed factor (P.04)

By means of parameter **P.04** the fan speed percentage may be set, in order to increase or decrease the combustion air quantity and ensure a correct combustion. Changing its value affects the fan speed percentage for the entire modulation curve. If it is set below 100 % the air quantity will decrease and if it is set a higher value the air quantity will increase. The range of values selectable is 0 - 200 % (by default 100%).

17.4 Fuel for ignition (P.05)

By means of parameter **P.05** the amount of fuel for burner ignition procedure may be set at desired value. The default value depends on the model of boiler and the type of fuel set. The range of values selectable is 10 - 900 g.

17.5 Fuel consumption (P.06)

By means of parameter **P.06** the amount of fuel consumed by the boiler at 100% heat output may be set, in kilograms per hour. This parameter is related to the boiler model (heat output) and the type of fuel used, as well as its calorific value.

DualTherm

17.6 Managing BT and BT-DUO buffer tanks (P.08, P.28)

Parameter **P.08** is used to set the type of hydraulic installation that has been used for the **BT** or **BT-DUO** buffer tank. This parameter depends on the installation and must be set by the installer once the buffer tank has been assembled. The factory default value is 0, management function of BT buffer tanks disabled. The electronic control of the **DualTherm** boiler is able to manage the operation of 4 different types of installation.

P.08 = 0 => Function disabled (default value).

P.08 = 1 => Installation with Sanit DHW tank after BT tank and control by temperature sensor.

P.08 = 2 => Installation with Sanit DHW tank before BT tank and control by temperature sensor.

P.08 = 3 => Installation with Sanit DHW tank after BT tank and control by thermostat.

P.08 = 4 => Installation with Sanit DHW tank before BT tank and control by thermostat.

When the installation type **1** or **2** is selected, by means of parameter **P.28**, it is possible to adjust the hysteresis of temperature for the sensor **Sbt**, in order to set the temperature to start up and stop the BT buffer tank heating operation. The parameter **P.28** can be adjusted between 5 and 40 °C and by default it is set to 5 °C.

17.7 Boiler minimum temperature mode (P.13, P.14)

By means of parameters **P.13** and **P.14** a different mode of temperature managing may be set (by default **P.13** = **2**), if heating or/and DHW services are enabled. When parameter **P.13** is set to 0, by parameter **P.14** the minimum temperature can be selected as desired, between 30 and 60 °C. The following regulation modes of minimum temperature can be selected:

P.13 = 0 => Maintains the minimum temperature set at **P.14** parameter.

P.13 = 1 => Maintains the boiler temperature set point.

P.13 = 2 => Does not maintain any boiler temperature.

17.8 Firewood firing power adjustment (P.32)

Through parameter **P.32**, it is possible to adjust the power to fire the firewood.

17.9 Minimum firewood combustion power adjustment (P.33)

The **DualTherm** boiler is configured to modulate its power between a minimum and maximum power. Through parameters **P.33**, it is possible to adjust the minimum power.

17.10 Fan speed during manual firewood firing (P.34)

Through parameter **P.34**, it is possible to adjust the fan speed during the manual firing process of the firewood (exclusive parameter for Mode 4). Changing its value adjusts the fan percentage during the manual firing process.

18 HEATING CIRCUIT'S SETUP PARAMETERS

DualTherm is equipped with an electronic controller to manage efficiently the automatic functioning of the boiler. It also has the following additional parameters to regulate the heating circuit connected. They only may be modified by a person with sufficient technical knowledge of the meaning of each parameter. Any inappropriate setting of a parameter of *"Technical Menu"* can cause a serious malfunctioning of the boiler and could cause damages to people, animals or things.

18.1 Heating pump post-circulation time (P.15)

This function keeps the heating pump (**BC**) running for a period of time after deactivating the heating service, to avoid the overheating due to the temperature inertias of the heating installation. By means of parameter **P.15** the period of time that the pump continues to operate may be set. The range of values selectable is 0 - 40 minutes (by default 3 minutes).

18.2 Boiler's pump operating mode (P.18)

The electronic controller allows to select between two operating modes of boiler's circulating pump (**BC**) by means of **P.18** parameter of the *"Technical Menu"*. The following operating modes can be selected:

- P.18 = 0** => Standard mode: The circulation pump will be run depending if the heating demand is activated or not. When a firewood load is fired and the installation does not have a buffer, the circulation pump of the boiler will continue to operate continuously.
- P.18 = 1** => Continuous mode: The pump continues to run provided that the heating mode is enabled (boiler temperature set point different to OFF). If there is room thermostat or remote control connected to the boiler, the electronic controller will regulate the burner functioning according to the heating demand, keeping the pump running continuously.

18.3 Minimum boiler water pressure (P.19)

DualTherm is equipped with a water pressure sensor that makes possible to know the pressure of the boiler. If the pressure descends below the value set at **P.19** parameter, the electronic controller locks out the functioning of the boiler and **E-19** alarm code is displayed (see *"Safety lock-outs"*). The range of values selectable is 0.1 - 0.5 bar (by default 0.5 bar).

18.4 Maximum heating flow temperature of mixed circuits (P.27)

The electronic controller allows to select the maximum heating flow temperature for mixed circuits installed in the boiler with an optional Bio Hydraulic Kit. By means of parameter **P.27** the maximum heating flow temperature may be set. The range of values selectable is 45 - 80 °C (by default 45 °C for mixed circuits)).

19 DHW CIRCUIT'S SETUP PARAMETERS

DualTherm is equipped with an electronic controller to regulate a Domestic Hot Water production service, if a DHW tank is connected to the boiler. The following parameters are used to set the parameters related to DHW service. These parameters are only displayed if a DHW tank is connected. They only may be modified by a person with sufficient technical knowledge of the meaning of each parameter. Any inappropriate setting of a parameter of *"Technical Menu"* can cause a serious malfunctioning of the boiler and could cause damages to people, animals or things.

DualTherm

19.1 DHW installation mode (P.09)

DualTherm could be set to be connected to a DHW production installation managed by a 3-way DHW diverter valve or by a hot water tank pump. These two operating modes can be selected by means of **P.09** parameter:

P.09 = 0=> 3-way DHW diverter valve installation.

P.09 = 1=> Hot water tank pump installation (by default).

19.2 DHW pump post-circulation time (P.16)

This function keeps the DHW valve or pump running for a period of time after deactivating de DHW service, to avoid the overheating of the boiler due to the temperature inertias of the DHW installation. By means of parameter **P.16** the period of time that the pump/valve continues to operate may be set. The range of values selectable is 0 - 20 minutes (by default 5 minutes).

19.3 Legionella protection function (P.17)

This option prevents the proliferation of legionella bacteria in the DHW tank. Every 7 days the temperature of tank hot water is increased to 70 °C to kill the bacteria. This function is only active if the boiler is turned on and a DHW tank is connected. By means of parameter **P.17** the protection against Legionella bacteria function may be activate or deactivate. By default this function is set deactivated.

19.4 DHW re-circulation function (P.20 = 2)

The multifunction of the auxiliary relay output allows to install a DHW re-circulating pump in DHW hydraulic circuit, in order to increase the comfort of DHW service. To activate this function read "*Multifunction-Relay functions*" section.

20 ADDITIONAL FUNCTIONS

DualTherm boiler includes the following additional control functions. They only may be modified by a person with sufficient technical knowledge of the meaning of each parameter. Any inappropriate setting of a parameter of "*Technical Menu*" can cause a serious malfunctioning of the boiler and could cause damages to people, animals or things.

20.1 CVS Suction System cycle time (P.22)

DualTherm boiler allows the installation of an optional automatic fuel loading system **named CVS Suction System**. By means of parameter **P.22** the activation cycle time of the loading system may be set. This parameter will be available only if an **CVS Suction System** is connected to the boiler. The range of values selectable is 35 - 195 seconds (by default 195 s). For a detailed information follow the instructions included within the **CVS Suction System**.

20.2 Reset default values (P.24)

In case any parameter is wrongly set or if the boiler works incorrectly, all the original values of the parameters can be reset automatically by selecting "Yes" in **P.24** parameter.

20.3 Pumps anti-lock function

This function prevents the boiler circulating pumps from locking if they have been out of use for a long period of time. This system remains enabled while the boiler is plugged into the mains.

20.4 Anti-frost function

This function protects the boiler from freezing during cold weather periods. If the boiler temperature drops below 6 °C, the heating pump will start running until the boiler temperature reaches 8 °C. If the boiler temperature continues to drop below 4 °C, the burner will start running, in order to heat the installation. It will continue working until the boiler reaches 15 °C. This system remains on standby while the boiler is plugged into the mains.

20.5 Boiler pressure sensor function

This function prevents boiler failure caused by a low or high water pressure level in the boiler. The pressure is detected by a pressure sensor and its value appears on the control panel display (in the "User Menu"). When the pressure drops below the pressure set at **P.19** parameter (by default 0.5 bar), the electronic controller locks out the boiler functioning and displays **E-19** alarm code on the screen. When the boiler pressure exceeds 2.5 bar, **(E-28)** alarm code is displayed on the screen, warning about the excess of pressure. When it occurs repeatedly it is recommended calling the nearest **Technical Assistance Service** and draining the boiler water until the pressure is between 1 and 1.5 bar.

20.6 Connecting the LAGO FB OT+ remote control

The boiler has the terminal strip **J5** for connecting the **LAGO FB OT+** remote control (see "Connection Diagram") that allows to regulate boiler's heating circuit according to the room temperature, besides adjusting the DHW temperature (as long as the DHW temperature sensor is connected in the boiler).

Installing a **LAGO FB OT+** remote control enables the heating and DHW services to adapt to the scheduled times of use of the installation. It also optimises the installation's functioning, adapting the heating temperature set point to the room temperature, improving the comfort.

20.7 Room thermostat connection

The boiler has a terminal strip **J6** for connecting a room thermostat or a room chrono-thermostat (TA₁, see "Connection Diagram") that allows to switch on and off the heating circuit demand according to the actual room temperature. The terminal strip **J6** is supplied with a electrical bridge connecting its terminals, so it will be necessary to remove it before connecting the room thermostat.

Installing a room thermostat will optimise the installation's performance, adapting the heating to building requirements and obtaining enhanced comfort. Also, if the thermostat allows the hours of functioning to be programmed (chronothermostat), it can adapt the heating system to the hours of use of the installation.

21 MULTI-FUNCTIONAL RELAY (P.20)

DualTherm is equipped with an auxiliary relay output that may be used to select a series of additional functions that increase the boiler performance, features and comfort of the installation.

Several operating modes may be set at **P.20** parameter of the *“Technical Menu”* to define the *“multi-functional relay”* function. The default value of this parameter is 0 (disabled). The following sections describe the functions that could be set.

21.1 Boiler alarms external signal (P.20 = 1)

When this function is selected (**P.20 = 1**) if the boiler shows an error or an operating alarm code the multi-functional relay output will be activated, supplying voltage (230 V~) between terminals no. **4**: **“NO”** and **N** of the terminal strip **J3**, where any external alarm signalling device may be connected to warn of boiler malfunctioning.

When the boiler lockage is reset, the multi-functional relay output will supply voltage again (230 V~) between terminals no. **3**: **“NC”** and **N** of the terminal strip **J3**.

21.2 DHW re-circulation function (P.20 = 2)

This function is available only if a DHW tank is connected on the boiler. The DHW recirculation function (**P.20 = 2**) will keep the whole DHW installation hot during the operating periods programmed in the boiler, so when any hot water tap is turned on the hot water will be supplied instantly, increasing the comfort of the DHW installation.

A DHW re-circulation pump will be required to install in the installation. This pump has to be connected in the multi-functional relay output, between the terminals No **4 (NO)** and **N** of the terminal strip **J3** (see *“Connections diagram”*). The hydraulic installation and electrical connection of re-circulation system must be made by qualified personnel.

During the operating periods programmed in the boiler, the multi-functional relay output will be activated, supplying voltage (230 V~) between terminals No **4 (NO)** and **N** of the terminal strip **J3**, where the recirculation pump must be connected. During the switched off periods programmed the multi-functional relay output will be deactivated, supplying voltage (230 V~) between terminals No **3 (NC)** and **N** of the terminal strip **J3** and the re-circulation pump will be stop.

21.3 Automatic water filling function (P.20 = 3)

DualTherm boiler may be connected to an automatic water filling system which can be activated or deactivated by **P.20** parameter.

It will be required to install a motorised valve to filling the water between the distribution water and the primary circuit of the boiler. This valve has to be connected in the multi-functional relay output between the terminals No **4 (NO)** and **N** of the terminal strip **J3** (see *“Connections diagram”*). The hydraulic installation and electrical connection of the automatic water filling system must be made by qualified personnel.

If the function is enabled (**P.20 = 3**) the electronic controller of the boiler will active the multi-functional relay output supplying voltage (230 V~) between the terminals No **4 (NO)** and **N** of the terminal strip **J3** (see *“Connections diagram”*) that activates the connected filling valve to refill the primary circuit up to the pressure set at **P.21** parameter. If the boiler pressure drops below the minimum pressure set at **P.19** parameter the boiler will automatically fill up again until the filling pressure value is reached.

22 CLEANING THE ASH DRAWER

The **DualTherm** boiler is equipped with an ash drawer, where the solid residues from the burnt fuel are collected on cleaning the burner and burning furnace. This drawer should be cleaned periodically. It is recommended to regularly check the drawer and remove the ash that has accumulated.

In addition, the lower area of the vents contains another ash drawer where solid remains are deposited. This box should be cleaned with a lower frequency than the burner's ash drawer and burning furnace.

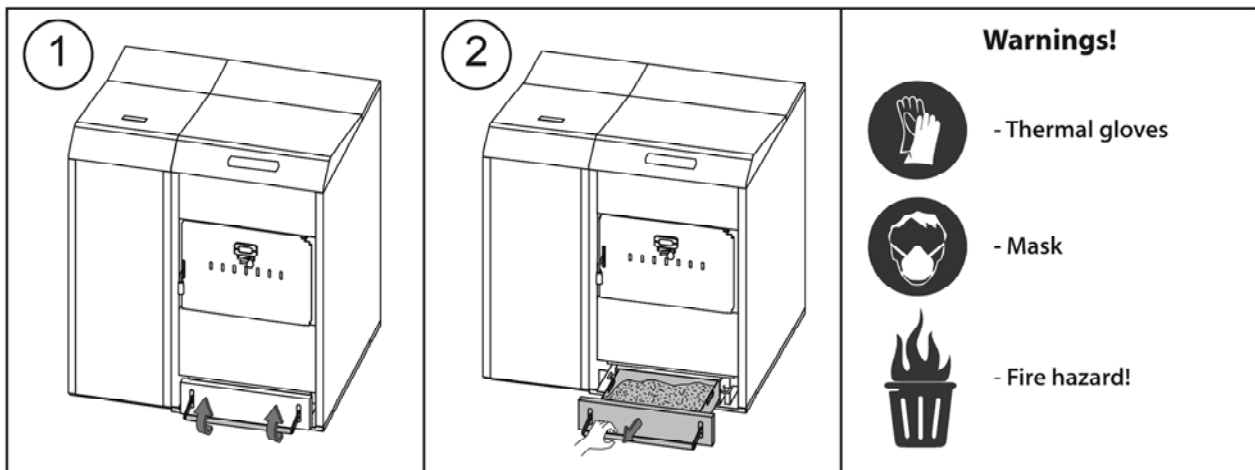

22.1 Safety warnings:

For **safe handling** of the ash drawer, you should take the necessary safety precautions and wear suitable clothing to protect against possible injury. The following advice should be particularly taken into account:

- **Switch off the boiler** before taking out the ash drawer. It is recommended to take out the ash drawer when no flame is detected in the burner.
- It is recommended to wear insulating **thermal gloves** to protect your hands from any burns from hot parts of the drawer.
- It is recommended you wear a protective **mask** to avoid breathing in any ash particles, particularly in the case of people with allergies or any type of respiratory problems, who should always wear a mask when carrying out ash removal.
- As the ash to be removed from the drawer may be burning or glowing, special precautions should be taken regarding to the type of container it is emptied into. A **metal** container is recommended, if not **the ash should be totally put out** using water or another extinguishing agent.

DOMUSA TEKNIK shall not be liable for any damage caused to people, animals or property as a result of incorrect handling of the ash drawer or the ash itself.

IMPORTANT: The ash drawer must only be cleaned when the boiler is switched off or on pause.

DualTherm

23 AIR ADJUSTMENT

The **DualTherm** boiler allows the manual adjustment of the secondary air. The aim of secondary air intake is to optimise firewood combustion while reducing emissions and improving boiler performance. By means of the firewood loading door regulator, the secondary air intake flow rate is regulated in the burning furnace.

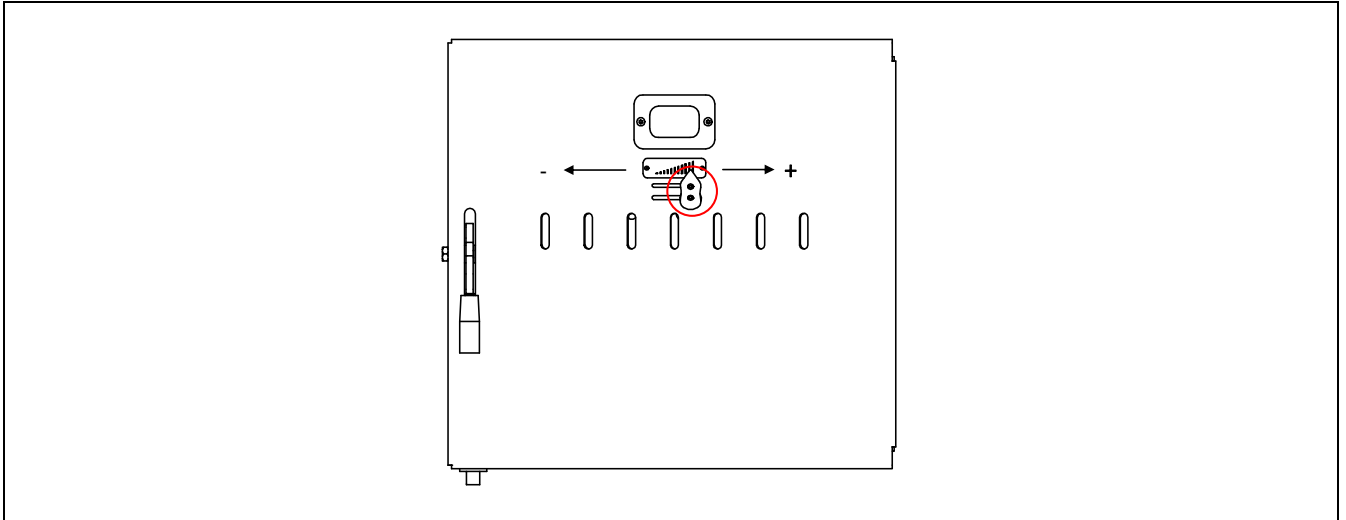

To regulate the air intake, slide the door regulator to the right or to the left depending on the amount of air you wish to supply to the burning furnace.

The secondary air inlet must be lowered or completely closed in the following cases:

- If large and/or high-humidity firewood is used
- If the firewood load is not fired properly with the pellet burner in Mode 2 (Combined Mode) or Mode 3 (Automatic Firewood)
- If work is to be performed exclusively with pellet

24 SAFETY LOCK-OUTS

The boiler's electronic controller may activate the following safety lock-outs to stop the boiler functioning in order to prevent serious damages. When any of these lock-outs occur, the boiler will switch off and an alarm code will be displayed on boiler's screen.

IMPORTANT: If any of the safety lock-outs described below should occur repeatedly, switch off the boiler and put in contact with the nearest official Technical Assistance Service.

24.1 Water overheat safety cut-out (E-11)

When this lock-out occurs "**E-11**" alarm code (temperature alarm) will appear on the screen. The burner will switch off and stop heating the installation.

This lock-out occurs when the temperature of boiler's water exceeds 110 °C. To unlock it, wait until the temperature drops below 100 °C and press the button of the safety thermostat, located underside of the electrical case of the boiler, after having removed the button cover:

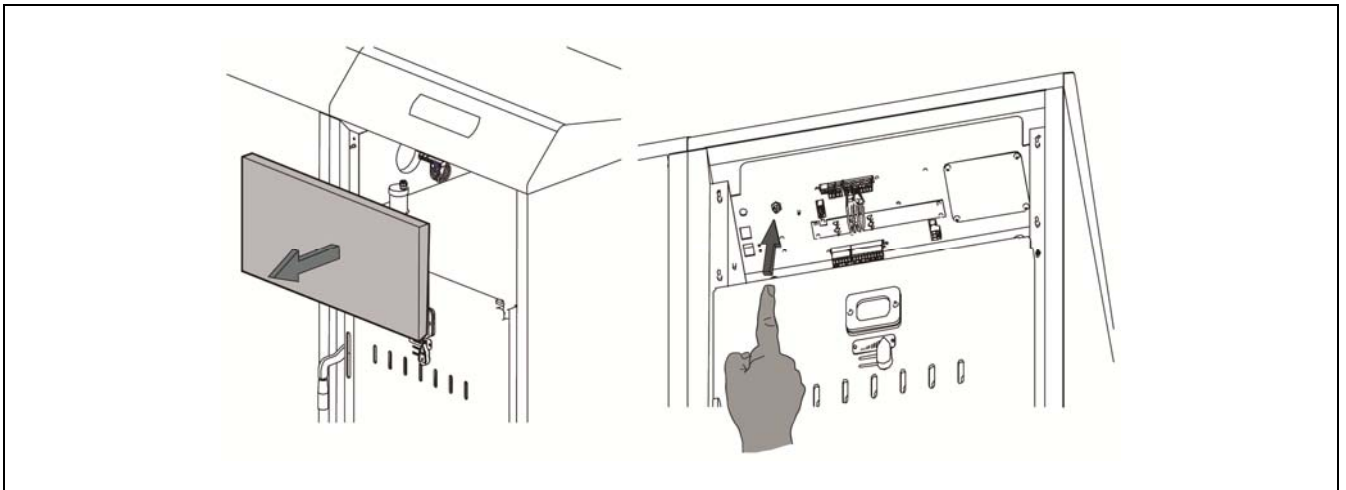

24.2 Fuel inlet tube overheat safety lock-out (E-05)

When this lock-out occurs "**E-05**" alarm code will appear on the screen. The burner will switch off and stop heating the installation.

This lock-out occurs when the temperature of the fuel entrance tube exceeds 80 °C. To unlock it, wait until the temperature drops and press the button on the safety thermostat using a screwdriver or a pen as is shown in the picture below:

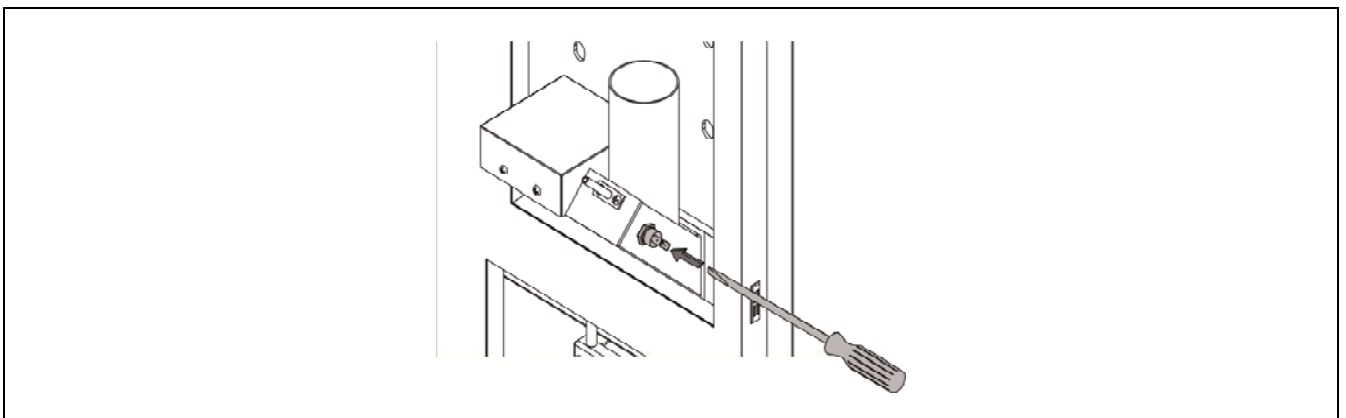

DualTherm

24.3 Low pressure lock-out

When this lock-out occurs, **"E19"** alarm code will appear on the digital display. The burner and the boiler's circulation pumps will switch off, cutting off the heating and water flow to the installation.

This lock-out occurs when the pressure of boiler's water drops below the value set at **P.19** parameter of *"Technical menu"* (by default 0.5 bar), preventing the boiler from functioning when the water is drained from the installation, due to either leakage or maintenance operations. To unlock this alarm, fill the installation again (see *"Filling the installation"*) up to 1 or 1.5 bar, displayed on *"Water pressure"* parameter of *"User menu"*.

25 SHUTTING DOWN THE BOILER

Press  during 1 second to shut down the boiler. When the boiler is shut down the heating and DHW services are switched off but anti-frost and pumps anti-lock functions continue activated whereas the boiler is kept connected to the power supply and fuel installation.

Unplug the boiler from the power supply and cut out the fuel supply to shut down the boiler completely.

26 EMPTYING THE BOILER

Use the drain cock located on the bottom of the backside of the boiler to empty it of water. Before opening it, connect a flexible pipe leaded to a sewer. After finishing the procedure, close the cock and remove de flexible pipe.

27 BOILER MAINTENANCE

Various maintenance operations should be carried out at different intervals of time to keep the boiler in perfect working order. The yearly maintenance operations should be carried out by personnel authorised by **DOMUSA TEKNIK**.

27.1 Frequency of maintenance of the boiler and chimney

The most important aspects to be checked are as follows:

N°	Operation	Frequency
1.	Check the fuel storage.	as required
2.	Clean the ash in the ash drawer.	as required
3.	Cleaning the burning furnace grill	as required
4.	Check the boiler visually.	weekly
5.	Check if the feed auger is correctly calibrated.	as required
6.	Check and clean the boiler fume circuit.	yearly
7.	Checking and cleaning the rear ash drawer	yearly
8.	Checking and cleaning the flue	yearly
9.	Check and clean the chimney. The chimney must be free of any obstacles and have no leaks.	yearly
10.	Clean the burner.	yearly
11.	Check the expansion vessel. It must be full, according to its data plate.	yearly
12.	Check the seal between the burner and the boiler.	yearly
13.	Check if the hydraulic circuits are correctly sealed.	yearly
14.	Check the water pressure of the boiler. When the installation is cold , it should be between 1 and 1.5 bar.	yearly

NOTE: Depending on the fuel type and weather conditions, it may be necessary to clean the combustion chamber of the burner at a bigger frequency.

DualTherm

27.2 Burner cleaning procedure

The following procedure is recommended for a correct cleaning of the burner:

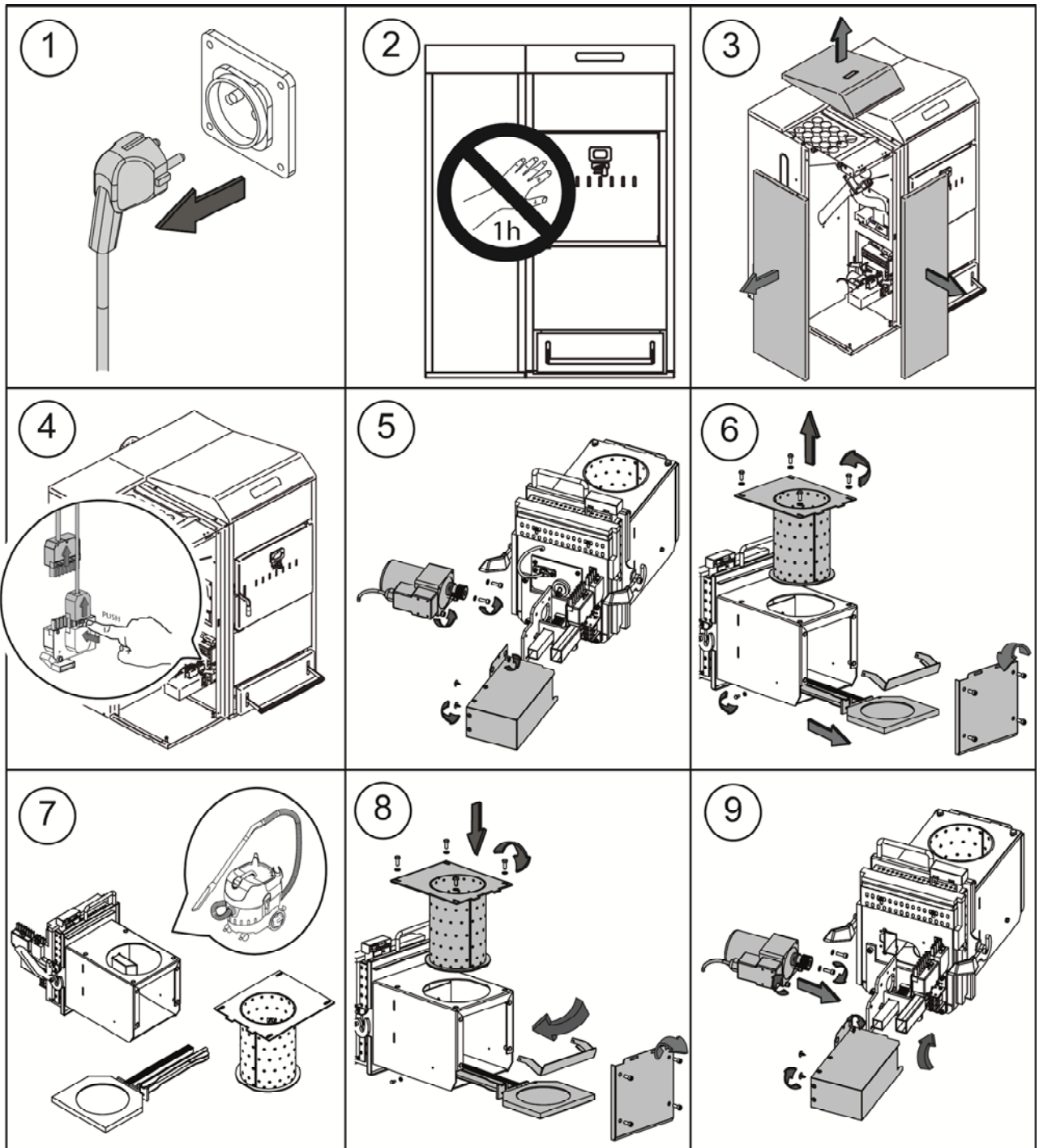

27.3 Cleaning the vents and rear ash drawer

The following procedure is recommended for correctly cleaning the vents:

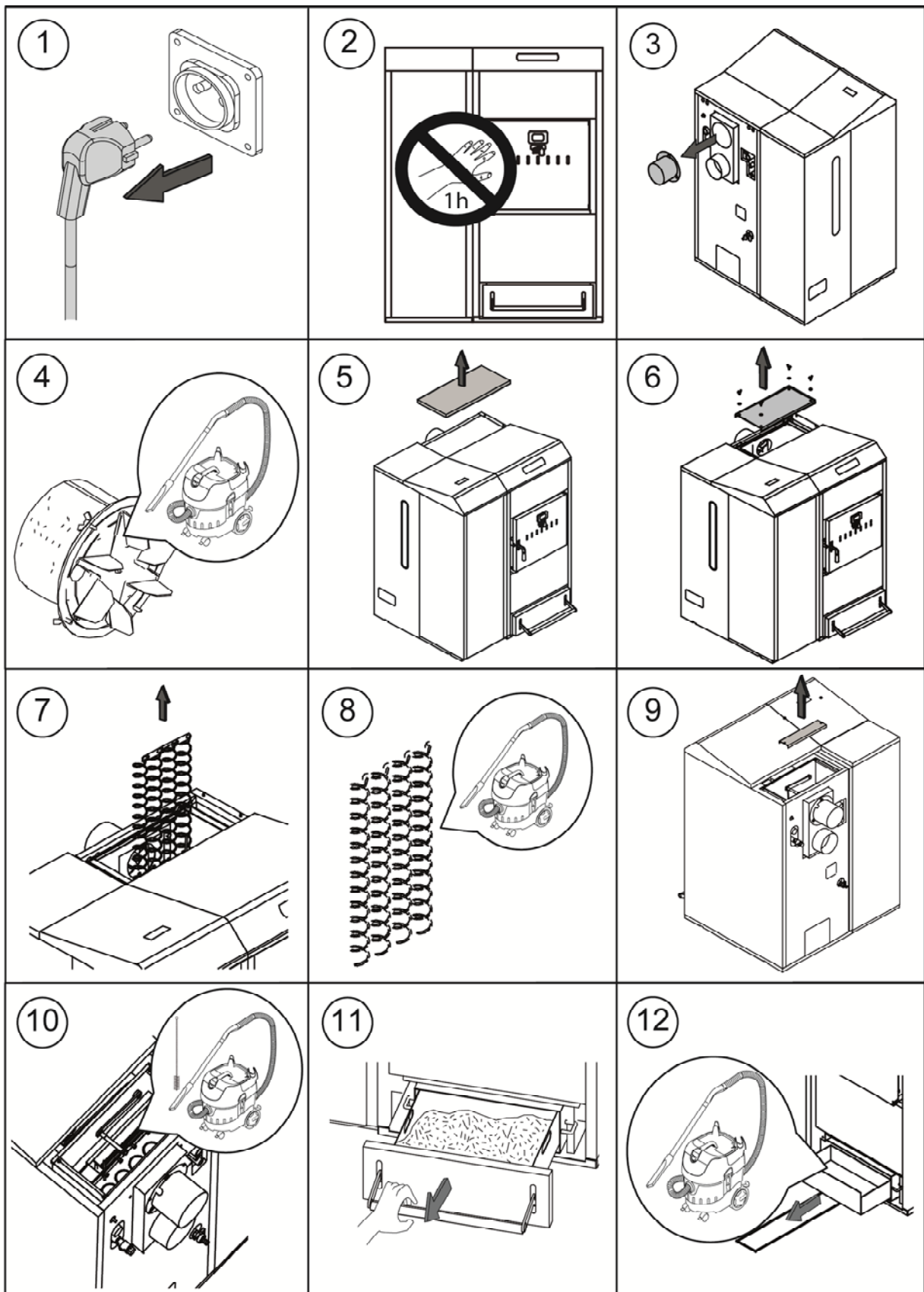

NOTE: Clean the rear ash drawer after cleaning the vents.

DualTherm

27.4 Deflector

The deflector is a crucial part for the correct operation of the boiler. It ensures optimal smoke flow and reduces combustion emissions. It should be in the correct position, and the boiler should never be used without the deflector. The deflector rests on the side brackets inside the burning furnace. Make sure that the deflector is placed at the bottom of the burning furnace.

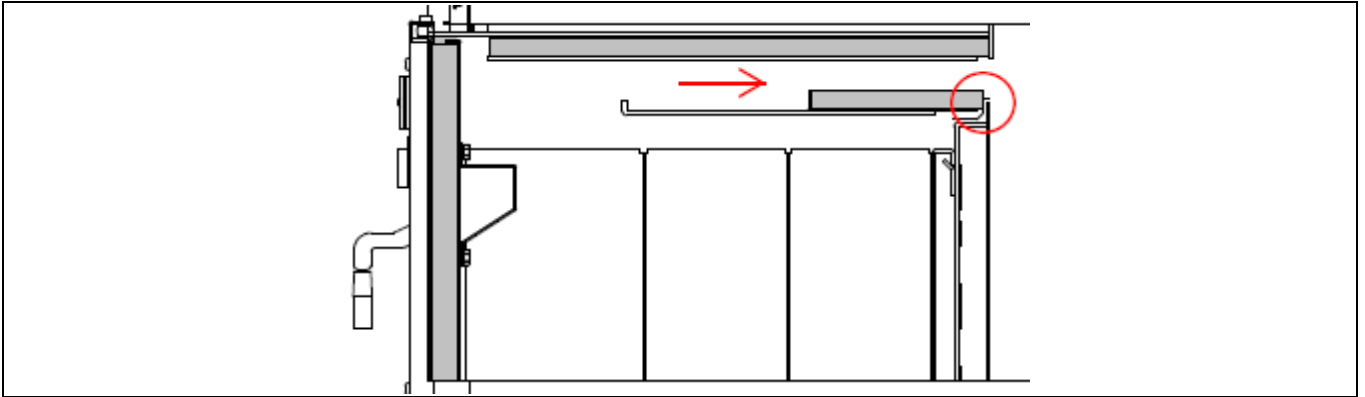

27.5 Fume temperature sensor

The DualTherm boiler has a fume temperature sensor. To replace it, insert the sensor into the hole provided in the back of the boiler:

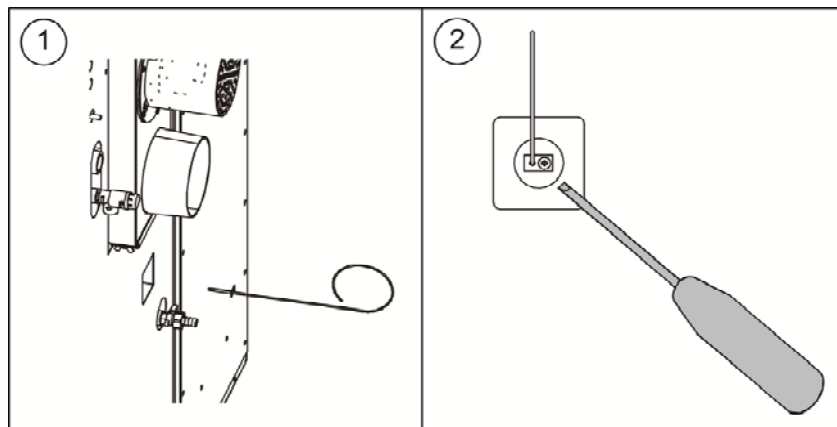

27.6 Draining the condensate water

The draining device to take out the condensate water from the chimney should not be altered in any way and it must be kept free of obstructions.

27.7 Boiler water characteristics

In areas with water hardness of over 25-30 °fH, treated water must be used in the heating installation to avoid any scale deposits on the boiler. It should be noted that even a few millimetres of scale will greatly reduce the boiler's heat conductivity, causing a major drop in performance.

Treated water must be used in the heating circuit in the following cases:

- Very large circuits (containing a large amount of water).
- Frequent filling of the installation.

If it is necessary to drain partially or totally the water of the installation very often, we recommend filling it with treated water.

28 DIAGRAMS AND MEASUREMENTS

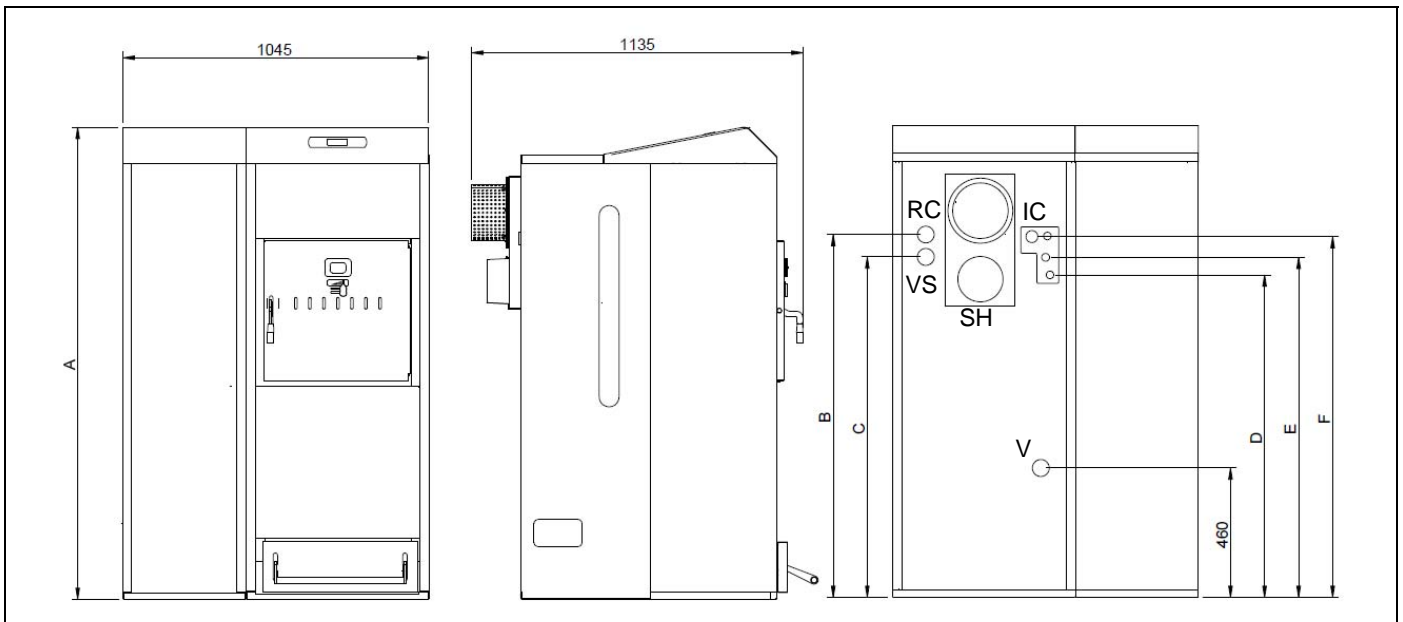

MODEL	A	B	C	D	E	F
DualTherm 25	1460	1080	1005	950	1010	1085
DualTherm 35	1610	1230	1155	1100	1160	1230

IC: Forward Heating (1" H)
RC: Backward Heating (1" H)
SH: Fume Output (Ø150 mm)
V: Empty
VS: Safety Valve ½" H.

Reserve tank

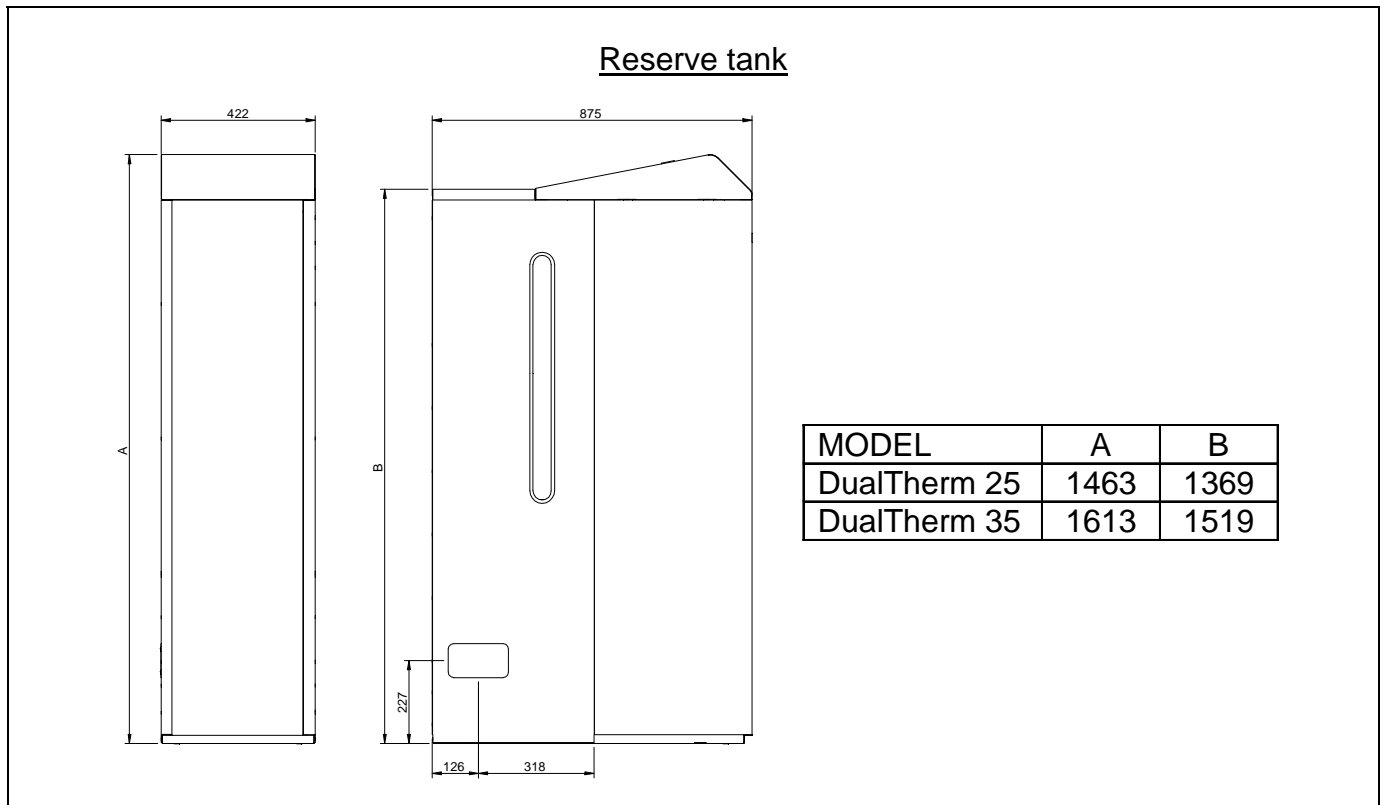

MODEL	A	B
DualTherm 25	1463	1369
DualTherm 35	1613	1519

DualTherm

29 CONNECTIONS DIAGRAM

29.1 Boiler

DualTherm

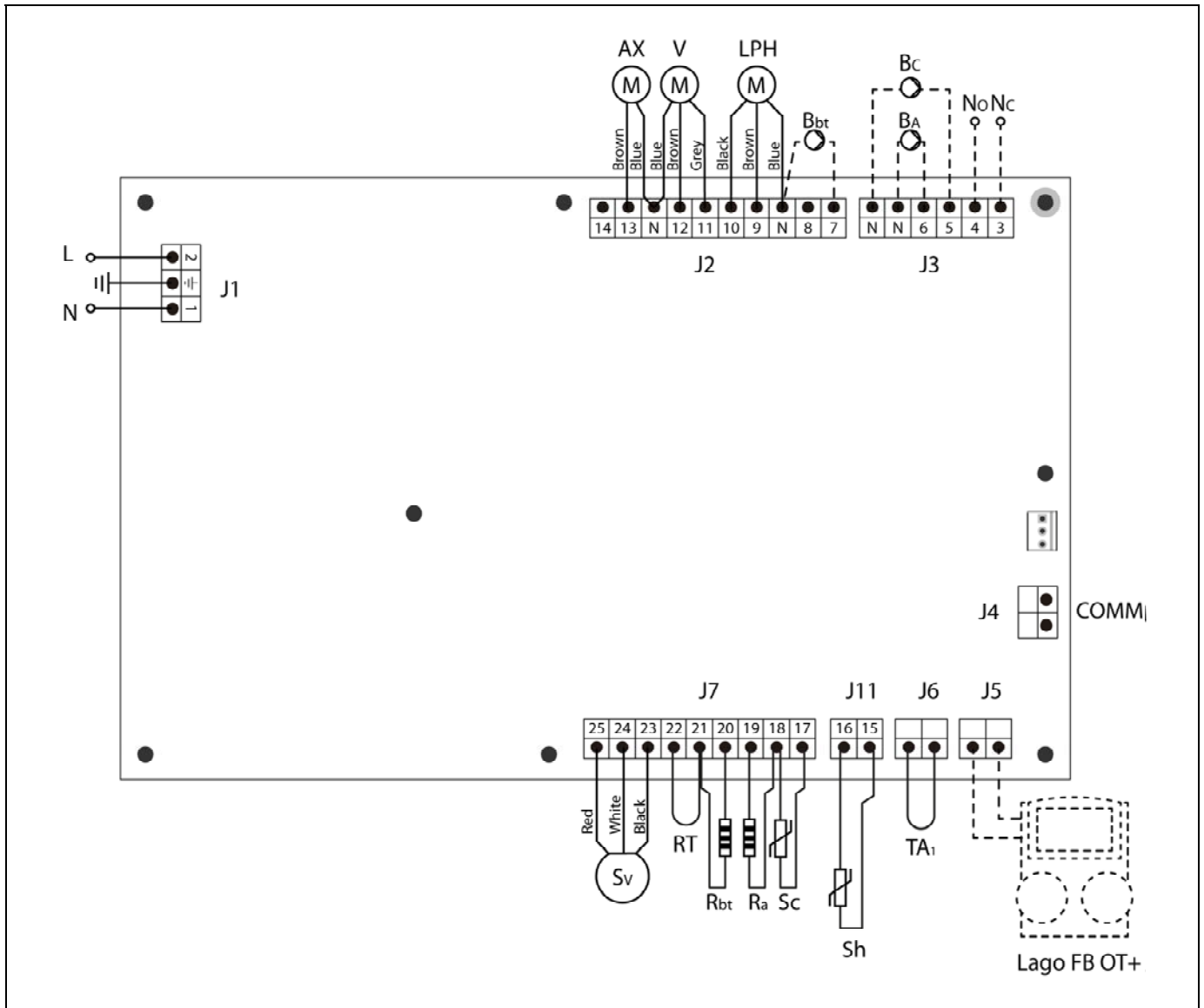

- L:** Phase.
- N:** Neutral.
- AX:** Feed auger.
- V:** Fan.
- LPH:** Heat exchanger cleaning device.
- Bbt:** BT buffer tank charging pump.
- BC:** Boiler pump.
- BA:** DHW tank pump or DHW valve.
- NO:** Multi-functional relay.
- NC:** Multi function relay.
- TA₁:** Room thermostat.
- Sc:** Boiler temperature sensor.
- Sh:** Flue (thermopar).
- Ra/Sa:** DHW tank option resistance.
- Rbt/Sbt:** Resistance for BT tank Option.
- RT:** Remote relay.
- Sv:** Fan speed sensor.
- J1:** Power supply connector.
- J2:** Component connector.
- J3:** Component connector.
- J4:** Communication connector.
- J5:** **LAGO FB OT+** remote control connector.
- J6:** Room thermostat connector.
- J7:** Sensors connector.

29.2 Burner

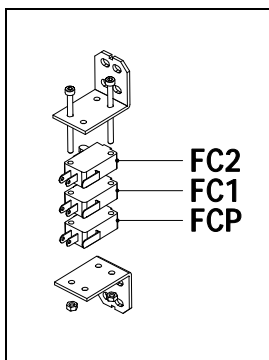
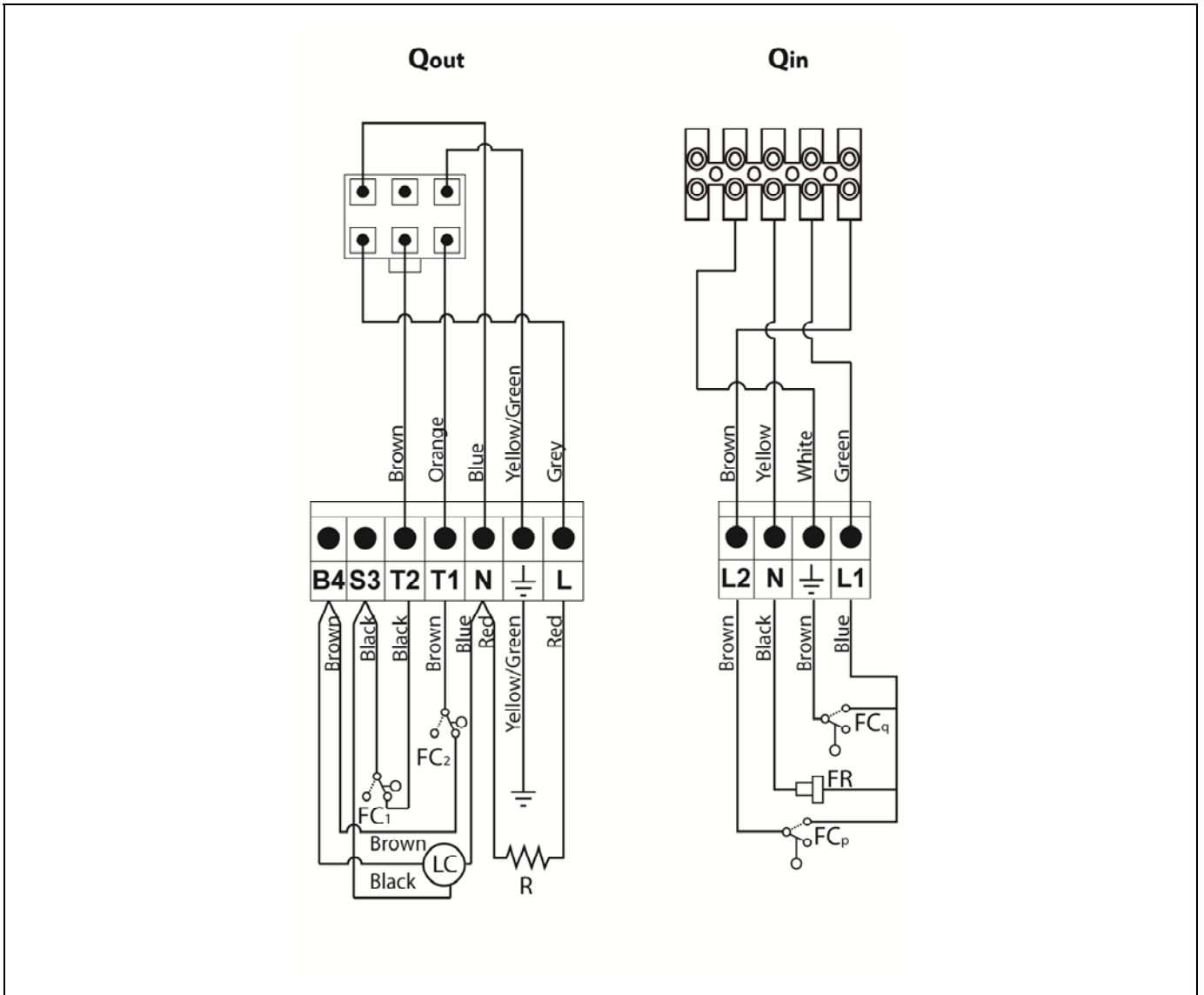

Qout: Burner outputs connector.

R: Ignition heater.

LC: Burner ash cleaning device.

FC₁: Closed switch.

FC₂: Open switch.

Qin: Burner inputs connector.

FC_q: Burner switch.

FR: Photocell.

FC_p: Ash cleaning device switch.

DualTherm

30 ELECTRICAL DIAGRAM

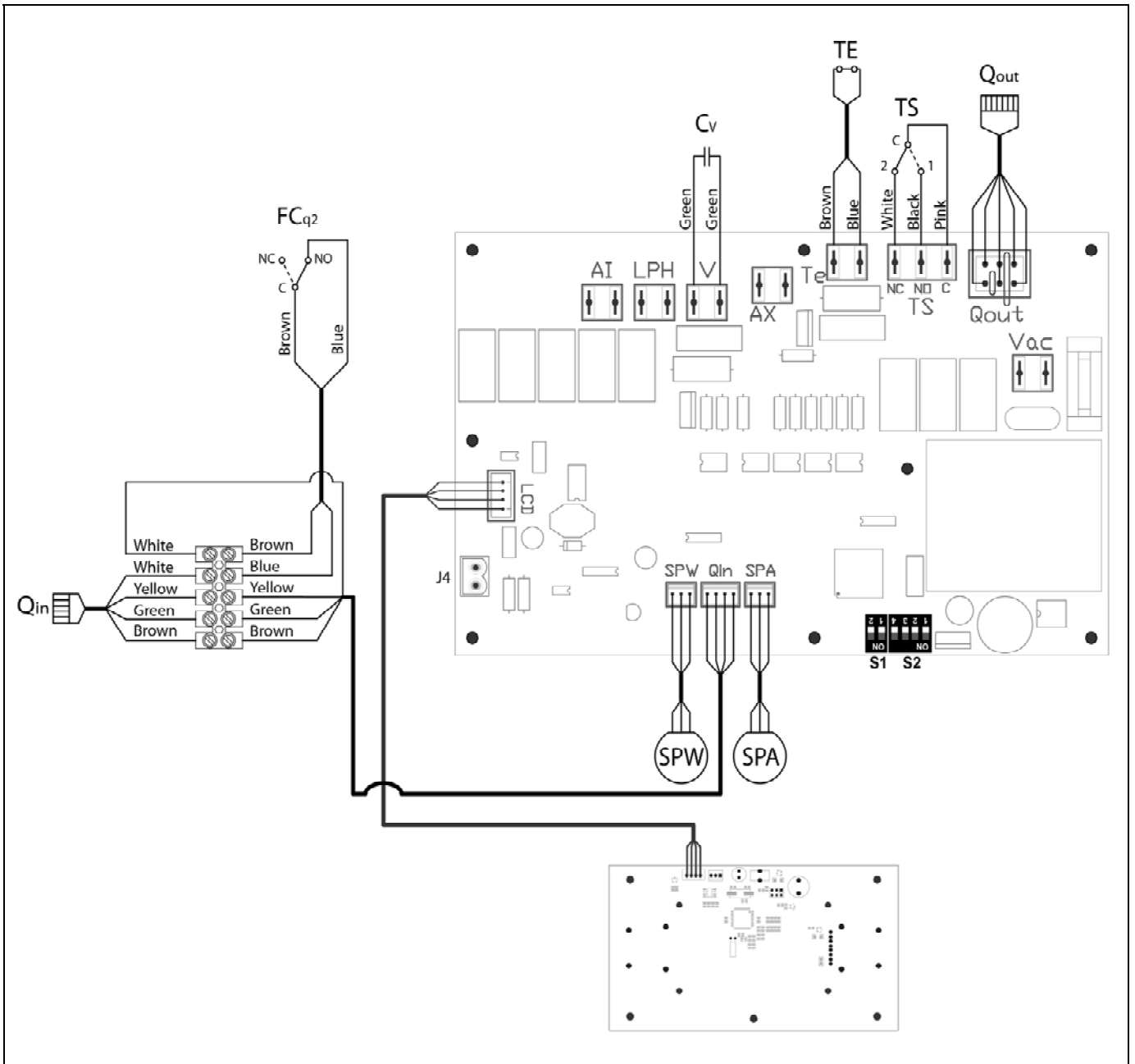

- TS:** Safety thermostat.
- TE:** Fuel entrance safety thermostat.
- Cv:** Fan capacitor.
- SPW:** Water pressure sensor.
- FCq2:** Furnace door limit switch
- SPA:** Air pressure sensor.

- Qout:** Burner outputs connector.
- Qin:** Burner inputs connector.
- LCD:** Display communication connector.
- J4:** Communication connector.
- S1, S2:** Boiler model DIP-switch.

31 TECHNICAL DATA

MODEL		DualTherm 25	Dualtherm 35
Maximum heat output	kW	25	35
Efficiency at maximum heat output	%	90,0	90,7
Minimum heat output	kW	7,5	10,5
Efficiency at minimum heat output	%	88,2	90,4
CO at maximum heat output (10% O ₂)	mg/m ₃	183	117
OGC (organic gaseous substances) at maximum heat output (10% O ₂)	mg/m ₃	9	3
Particles content at maximum heat output (10% O ₂)	mg/m ₃	16	23
CO at minimum heat output (10% O ₂)	mg/m ₃	337	137
OGC (organic gaseous substances) at minimum heat output (10% O ₂)	mg/m ₃	20	4
Boiler class (according to EN 303-5)	-	Class 5	Class 5
Maximum operating pressure	bar	3	3
Maximum operating temperature	°C	85	85
Maximum safety temperature	°C	110	110
Water volume	litres	83	104
Minimum flue draught	mbar	0,10	0,1
Maximum flue draught	mbar	0,20	0,2
Electrical supply	-	230 V~, 50 Hz, 2.5 A	230 V~, 50 Hz, 2.5 A
Boiler chimney diameter	mm	150	150
Fume temperature at rated power with pellet	°C	140	140
Mass flow rate of fumes (wet basis) at rated power	Kg/s	0.020	0,025
Fuel	-	Wooden pellet Ø6 mm. Maximum length 35 mm.	Wooden pellet Ø6 mm. Maximum length 35 mm.
Maximum water content of the fuel	%	7	7
Minimum return temperature	°C	35	35
Water pressure drop (dT = 20 K)	mbar	206	250
Stand by power	W	3	3
Weight (net)	Kg	423	454

32 CIRCULATION PUMP AND PRESSURE DROP

DualTherm boiler can be installed with a circulation pump supplied by DOMUSA TEKNIK. This pump can be a conventional pump or a high efficiency circulation pump.

32.1 High efficiency circulation pump

The **high efficiency circulation pump** allows savings of up to 70 % in energetic consumption in comparison to conventional pumps. The pump can be adjusted in two ways:

1-Constant speed I, II, III (traditional mode):

The pump operates at a constant, pre-set speed.

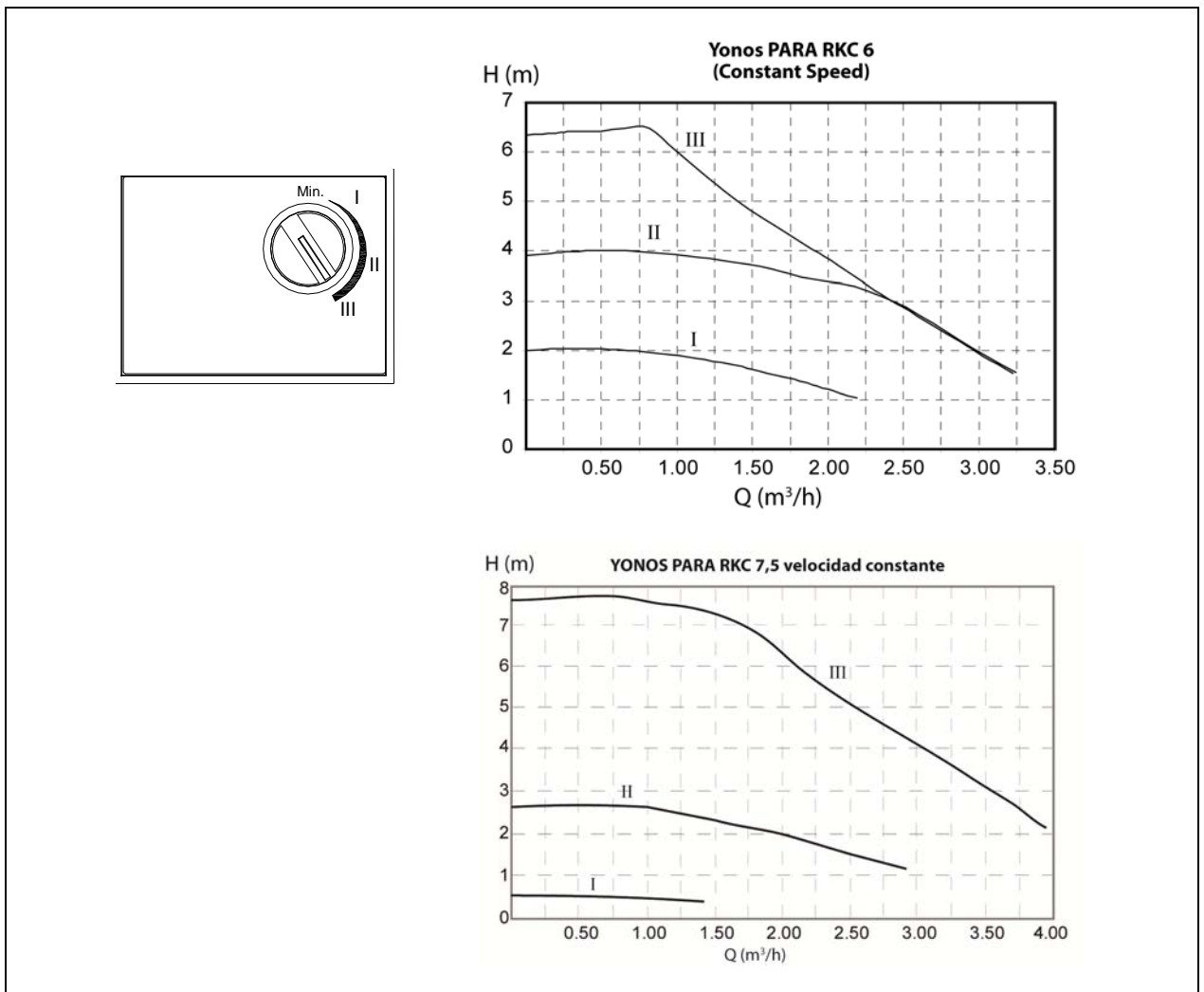

2-Variable differential pressure ($\Delta p-v$):

The setpoint value of the differential pressure H increases in a straight line between $\frac{1}{2}H$ and H within the permitted flow margin. The differential pressure generated by the pump is adjusted to the appropriate setpoint value of differential pressure.

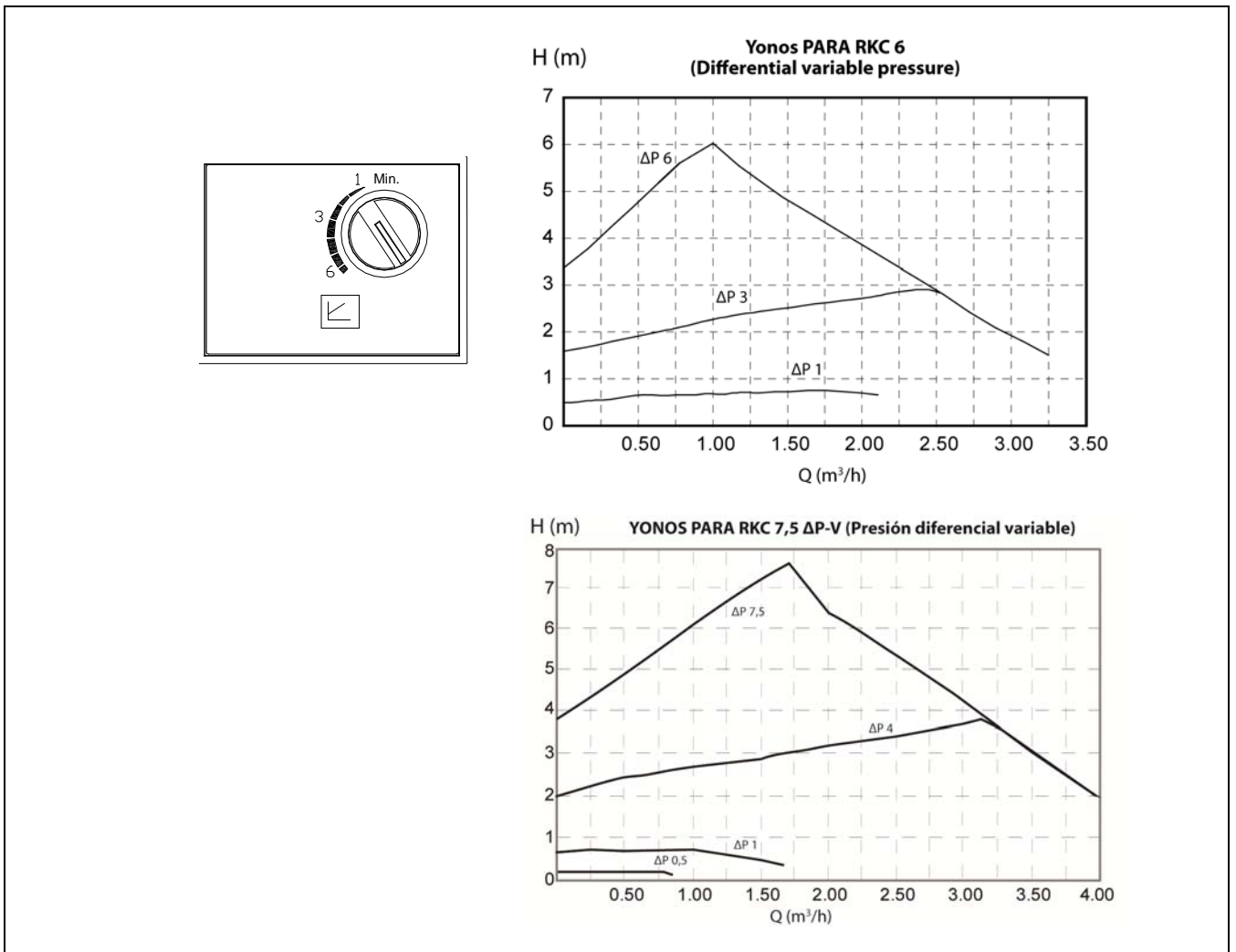

For the appropriate sizing of the hydraulic installation, as well as the pump operation curves, the pressure loss caused by the boiler should be taken into account. The following graph describes the load loss curves of the boiler:

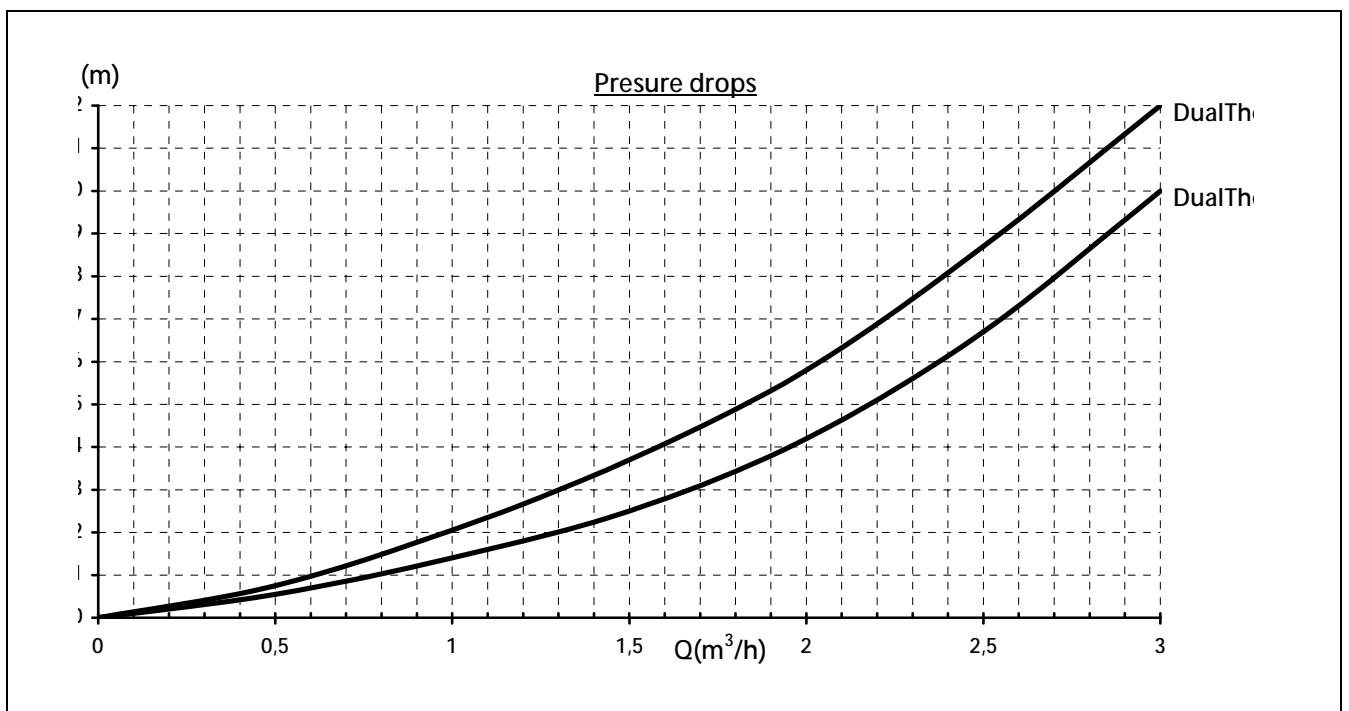

33 SPARE PARTS LIST

Boiler

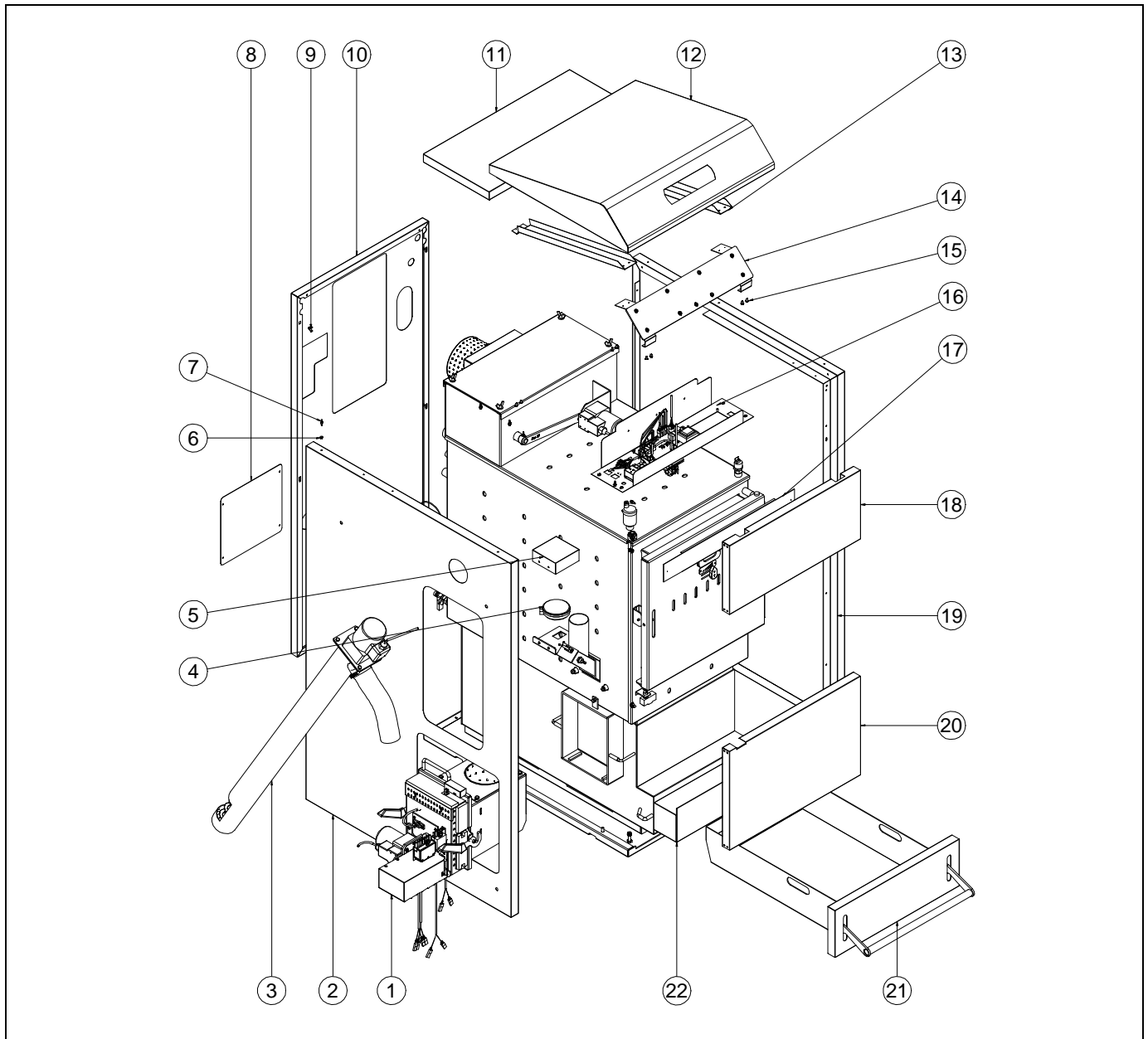

No.	Code	Description	No.	Code	Description
1	RQUEBIO016	BIOCLASS HM 25 Burner	12	SEPO002397	Roof
	RQUEBIO018	BIOCLASS HM 43 Burner	13	SCHA011882	Front fastening
2	SEPO002386	Boiler left side panel (25)	14	SELEDUA000	Front
	SEPO002625	Boiler left side panel (35)	15	CTOR000073	Threaded screw lock
3	RALMDUA000	Supply line	16	SELEDUA001	Cabinet (25)
4	CELC000331	HUBA pressure sensor		SELEDUA003	Cabinet (35)
5	SEPO002383	Pressure sensor cover	17	SEPO002399	Insulation fastening
6	CTOR000089	Hex nut with DIN-6923 washer	18	SEPO002392	Boiler top front panel
7	CTOE000355	Connection clip pivot	19	SEPO002384	Boiler right side panel (25)
8	SEPO002576	Ash dump rear cover		SEPO002623	Boiler right side panel (35)
9	CFER000261	Spring closure	20	SEPO002394	Boiler bottom front panel (25)
10	SEPO002387	Boiler rear panel (25)		SEPO002626	Boiler bottom front panel (35)
	SEPO002624	Boiler rear panel (35)	21	SCON001414	Ash dump
11	SEPO002390	Boiler ceiling	22	SCON001403	Rear ash dump

Boiler

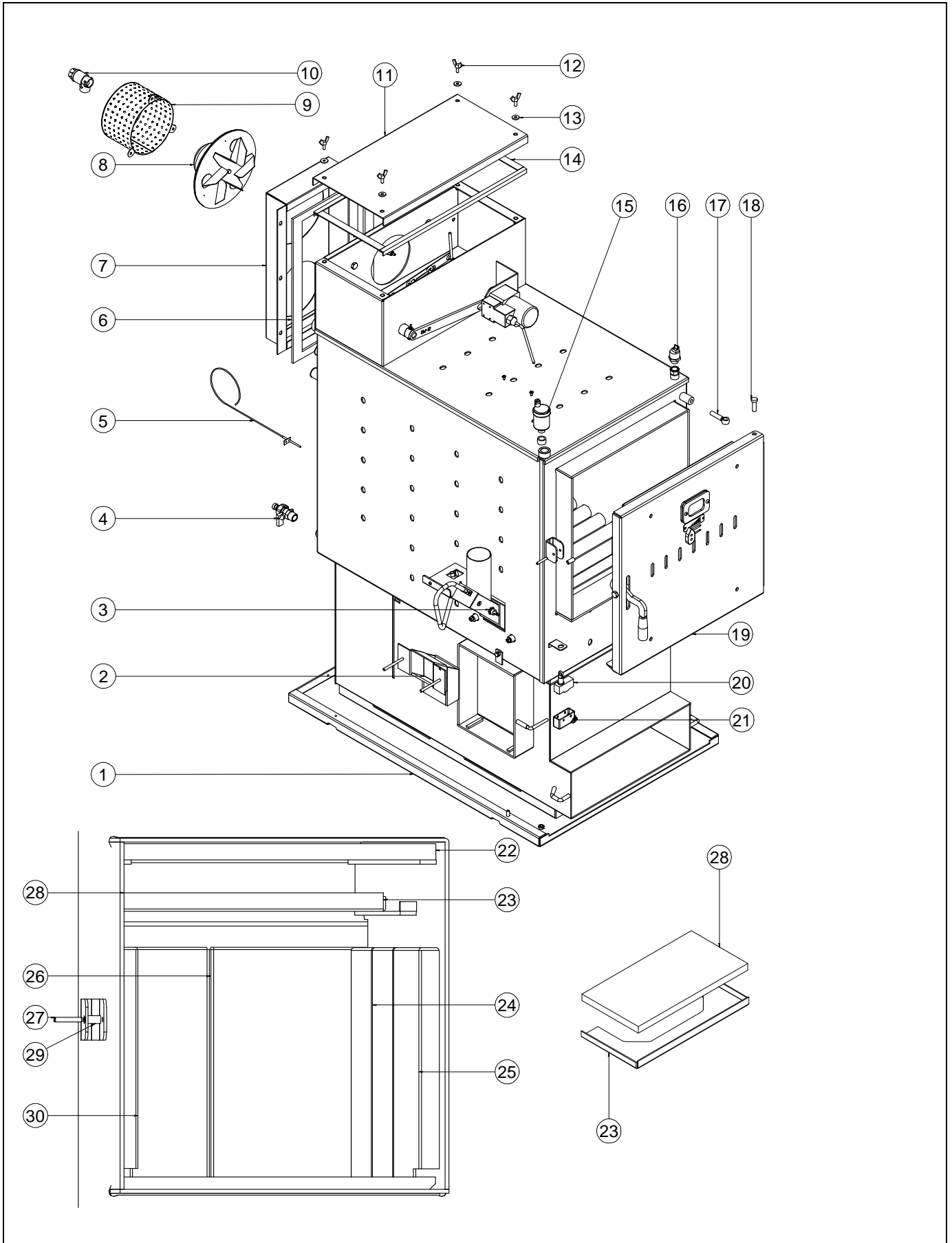

DualTherm

No.	Code	Description
1	RCON000953	Heat exchanger
2	RCON000954	DUALTHERM 25 internal supply line
3	CELC000333	80°C bimetallic thermostat
4	CVAL000034	½ drain wrench with chain
5	CELC000460	Type J thermocouple
6	SAIS000175	Insulator for fan box
7	SCON001386	DUALTHERM 25 manifold housing
8	RCON000956	Fan
9	SEPO002382	Fan protector
10	CVAL000017	HH ½ safety valve without T.M.
11	SCON001412	Fume chamber cover
12	CTOR000183	M6x20 butterfly screw
13	CTOR000122	DIN-9021 M6 flat washer
14	MAIS000080	Glass tape
15	RFOV000024	Trap assembly
16	CELC000252	Pressure transducer
17	CTOE000377	M10x40 eye bolt
18	CFER000249	Door pin
19	RCON000955	Door
20	CELC000416	DUALTHERM door limit switch
21	CELC000417	Door limit switch protector
22	CAIS000007	Top vermiculite
23	SCHA011736	Vermiculite protector
24	SCHA012207	Side anti-condensation (25)
	SCHA012249	Side anti-condensation (35)
25	SCHA01SCHA01	Side anti-condensation (25)
	SCHA012248	Side anti-condensation (35)
26	SCHA012210	Rear anti-condensation (25)
	SCHA012250	Rear anti-condensation (35)
27	CFER000309	Elastic pin
28	CAIS000027	Deflector vermiculite
29	CTOE000372	Closure bushing
30	SCHA012211	Side anti-condensation (25)
	SCHA012251	Side anti-condensation (35)

Hopper

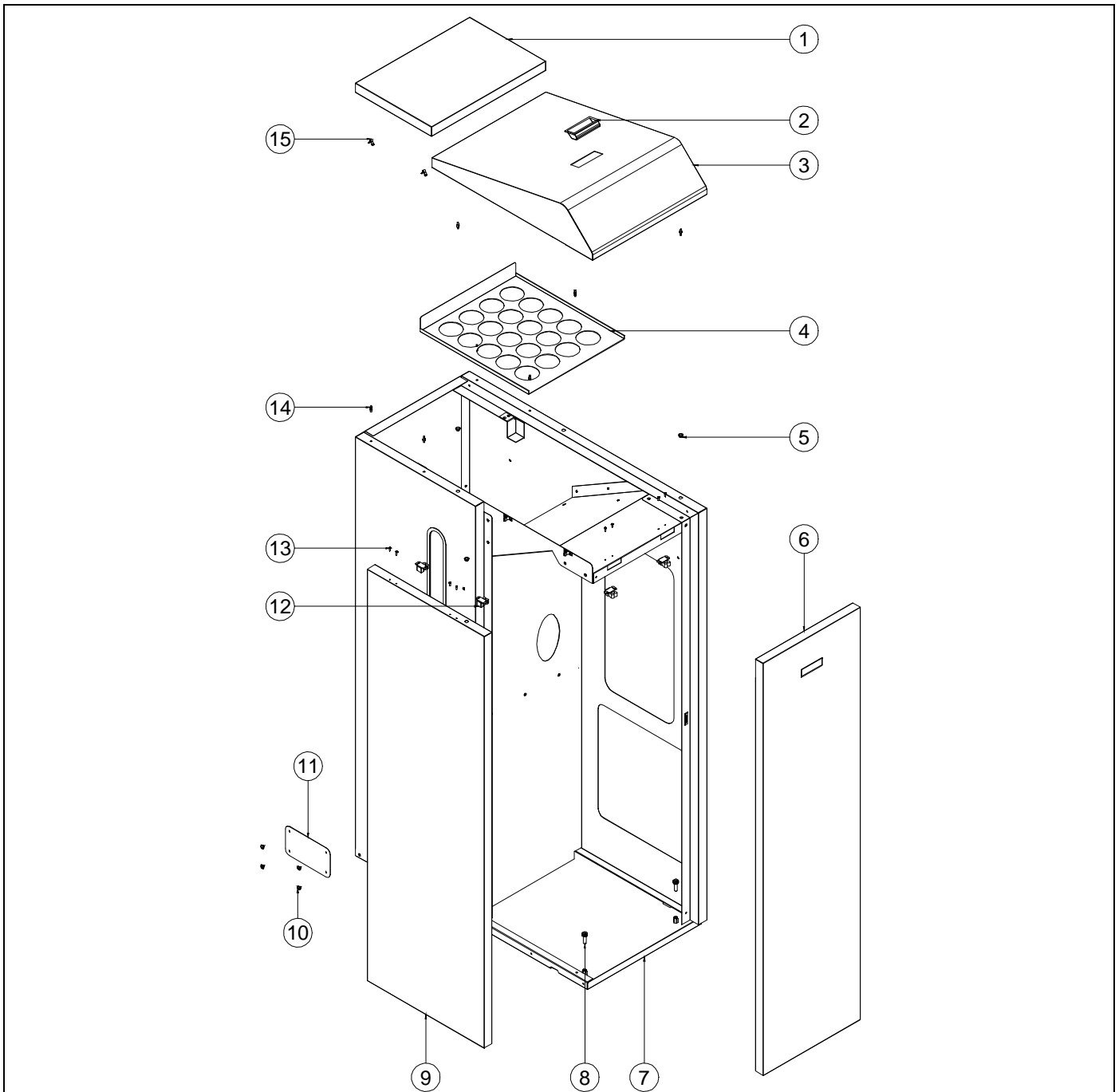

N°.	Code	Description	N°.	Code	Description
1	SEPO002395	Rear top cover	8	CTOR000127	DIN-912 M8x25 screw
2	CFER000020	Handle	9	SEPO002393	Lateral panel (25)
3	SEPO002892	Top cover		SEPO002629	Lateral panel (35)
4	SEPO002402	grate	10	CTOR000214	PH 4,2x13 screw
5	CFER000002	Pivot cover PL/126-P	11	SEPO001430	Cover for the oval
6	RCON000960	Front panel (25)	12	CFER000045	Fastener
	RCON000967	Front panel (35)	13	CTOR000113	DIN-7981 3,9x9,5 screw
7	RCON000965	Hopper body (25)	14	CTOE000355	Pivot
	RCON000968	Hopper body (35)	15	CFER000261	Spring

DualTherm

Heat exchanger camshaft system

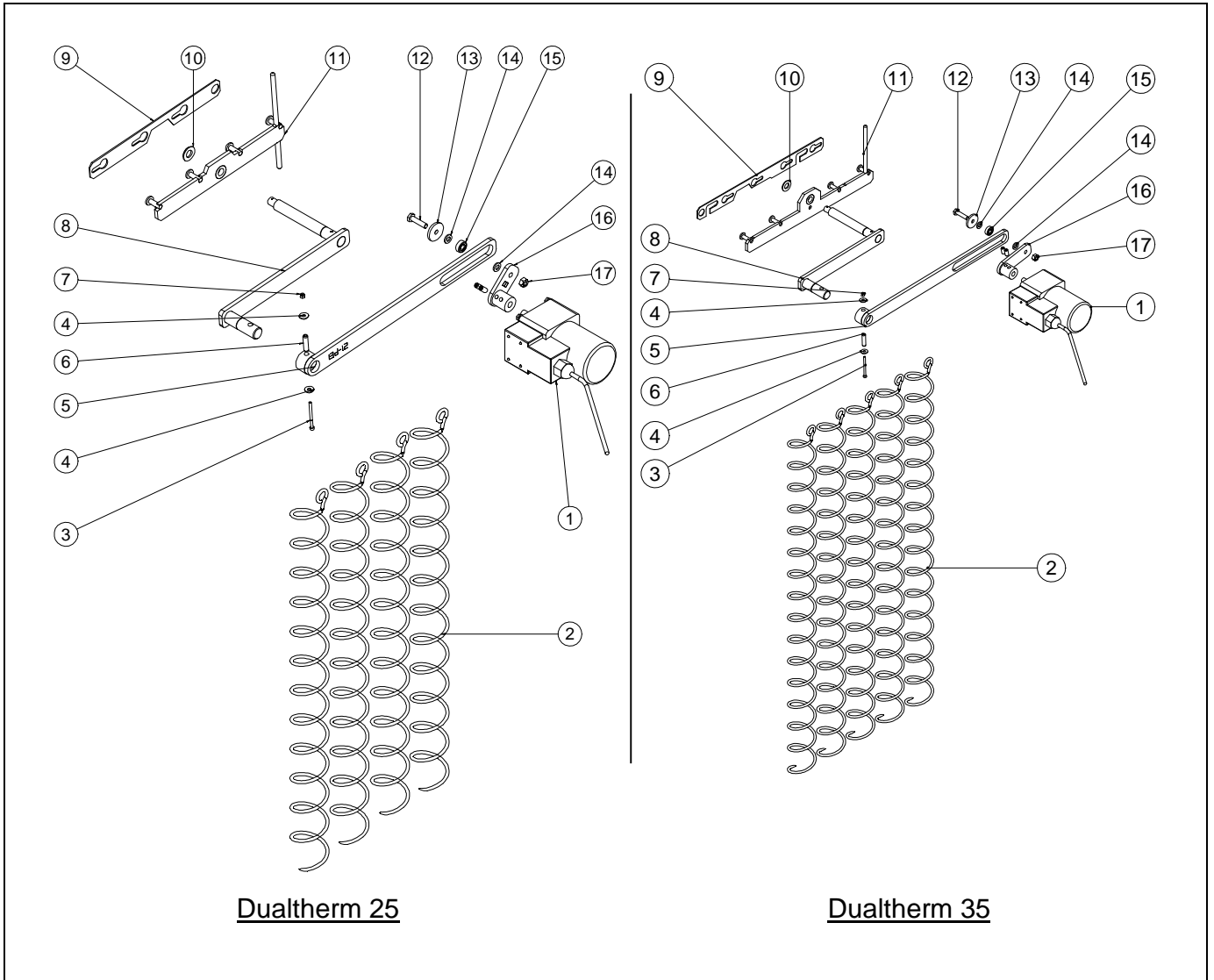

Dualtherm 25

Dualtherm 35

No.	Code	Description
1	CFOV000134	YN 60 motor
2	CTOE000370	Deflector coil (25)
	CTOE000383	Deflector coil (35)
3	CTOR000064	Screw Cab. Allen DIN-912 M3x40
4	CTOR000132	DIN-9021 flat washer
5	SCON000305	Plate sub-unit (25)
	SCON001484	Plate sub-unit (35)
6	CFER000292	DIN-7343 coil pin
7	CTOR000280	Self-locking hex nut
8	SCON001401	Inner plate sub-unit (25)
	SCON001482	Inner plate sub-unit (35)
9	SCHA011031	Cleaning plate holder (25)
	SCHA010996	Cleaning plate holder (35)
10	CTOR000162	DIN-125 flat washer
11	SCON001262	Cleaning plate sub-unit (25)
	SCON001460	Cleaning plate sub-unit (35)
12	CTOR000146	Screw Cab. Hex. DIN-933
13	CTOE000172	Cam system washer
14	CTOR000084	DIN-125 flat washer
15	CFER000129	696 2Z bearing
16	SCON000307	Transmission crank sub-unit (25)
	SCON001479	Transmission crank sub-unit (35)
17	CTOR000230	Hex nut DIN-985 self-locking nut

Feed auger

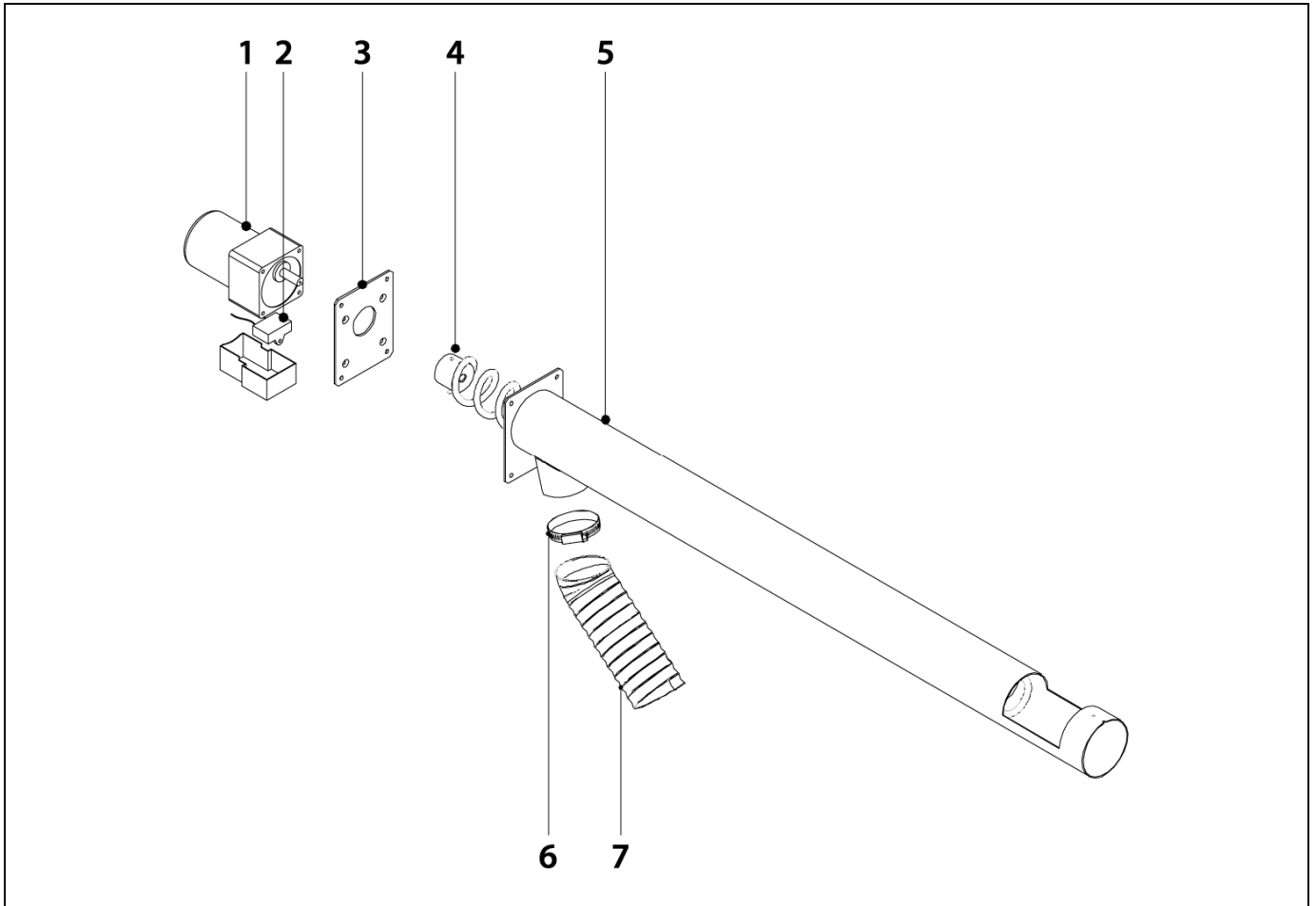

<u>No.</u>	<u>Code</u>	<u>Description</u>
1	CFOV000136	25W motor transmission 1/180
2	CFOV000142	YN 80 condenser
3	SEPO001637	Fixing plate
4	SCON000579	Feed Screw 25/43
5	SEPO001612	Feed tube 25/43
6	CFER000019	Bracket
7	STUR000030	DUALTHERM anti-static flexible tube
	RALMDUA000	Supply line

DualTherm

Burner

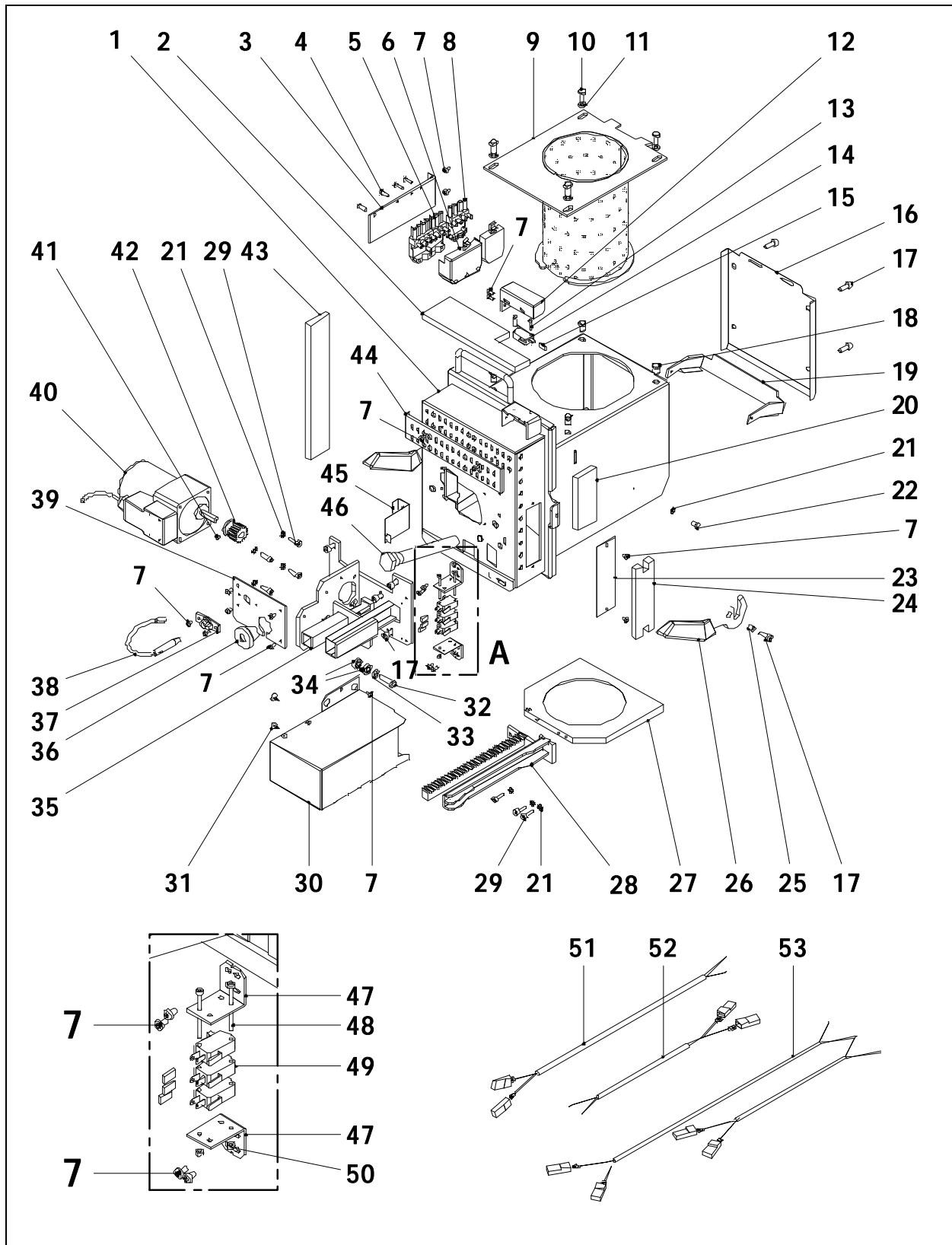

Nº.	Código	Name	Nº.	Código	Name
1	SCON000935	Burner body (25)	27	CFUR000032	Burner cleaner (25)
	SCON001084	Burner body (35)		CFUR000033	Burner cleaner (35)
2	MAIS000162	Top insulation (25)	28	RCON000008	Rack sub-unit (25)
	MAIS000163	Top insulation (35)		RCON000009	Rack sub-unit (35)
3	SEPO002175	Connectors support	29	CTOR000266	DIN-912 M5x16 screw
4	CTOR000100	Screw for plastic 4,1x16	30	RBIO000033	Protection cover (25)
5	CQUE000042	7-pole connector		RBIO000034	Protection cover (35)
6	CQUE000135	7-pole connector cover	31	CTOR000214	4,2 x 13 black screw
7	CTOR000242	DIN-7985 M4x7 screw	32	CTOR000146	DIN-933 M6x25 screw
8	CQUE000303	4-pole connector	33	CTOR000084	DIN-125-A2 M6 washer
9	RCON000005	Burning pot 25	34	CFER000129	696 2Z bearing
	RCON000006	Burning pot 35	35	RCON000010	Motor support
10	CTOR000222	DIN-933 M6x16 INOX. screw	36	CFER000135	Cable duct
11	CTOR000223	DIN-125-A2 M6 INOX. washer	37	CQUE000149	Photocell support
12	SEPO002174	Burner position sensor cover	38	CQUE000181	Photocell
13	CTOR000209	DIN-7985 M3x15 screw	39	SEPO002109	Burner cover
14	CELC000327	Burner position sensor.	40	CFOV000147	Motor
15	CELC000352	Cap	41	CTOR000257	DIN-916 M6x6 stud
16	SCON001294	Rear burner cover. (25)	42	RCON000011	Pinion sub-unit
	SCON001295	Rear burner cover. (35)	43	MAIS000159	Left side insulation (25)
17	CTOR000265	DIN-912 M6x14 screw		MAIS000165	Left side insulation (35)
18	CTOR000226	Blind rivet nut	44	SEPO001807	Air regulation cover
19	SCON001291	Flap (25)	45	SCHA009399	Photocell cap
	SCON001292	Flap (35)	46	CRES000035	Electrical resistor
20	MAIS000161	Right side insulation (25)	47	SEPO002105	Cleaner sensor support
	MAIS000164	Right side insulation (35)	48	CTOR000064	DIN-912 M3x40 black screw
21	CTOR000108	DIN-6798-A M5 washer	49	CELC000332	Cleaner sensor
22	CTOR000102	DIN-933 M4x8 screw	50	CTOR000151	DIN-934 M3 nut
23	SCON001296	Burner body cover	51	CELC000357	Cleaner sensor cable (Black)
24	MAIS000166	Cover insulation	52	CELC000356	Cleaner sensor cable (Brown)
25	CTOE000168	Sleeve bushing	53	CELC000346	Burner harness
26	CQUE000177	Lever			

DualTherm

Manual ash dump

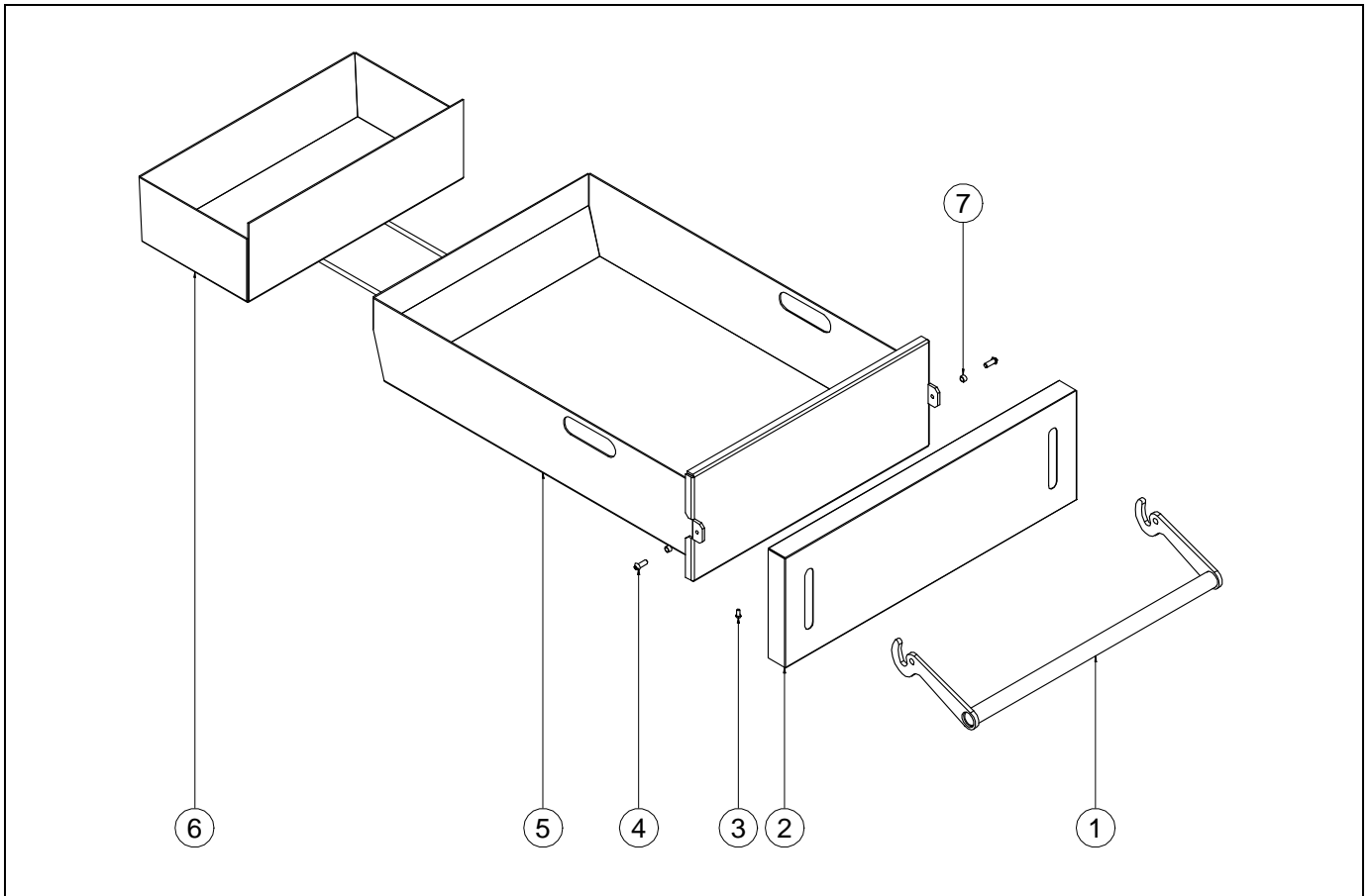

No.	Code	Description
1	SEPO002577	DUALTHERM ash dump handle sub-unit
2	SEPO002434	Ash dump cover
3	CTOR000232	DIN-7981 threaded screw lock
4	CTOR000282	DIN-7380 Allen red. cab. screw
5	SCON001416	Manual ash dump with insulators
6	SCON001403	Rear ash dump
7	CTOE000299	Lever bushing

Electrical board Burner

SELEDUA001

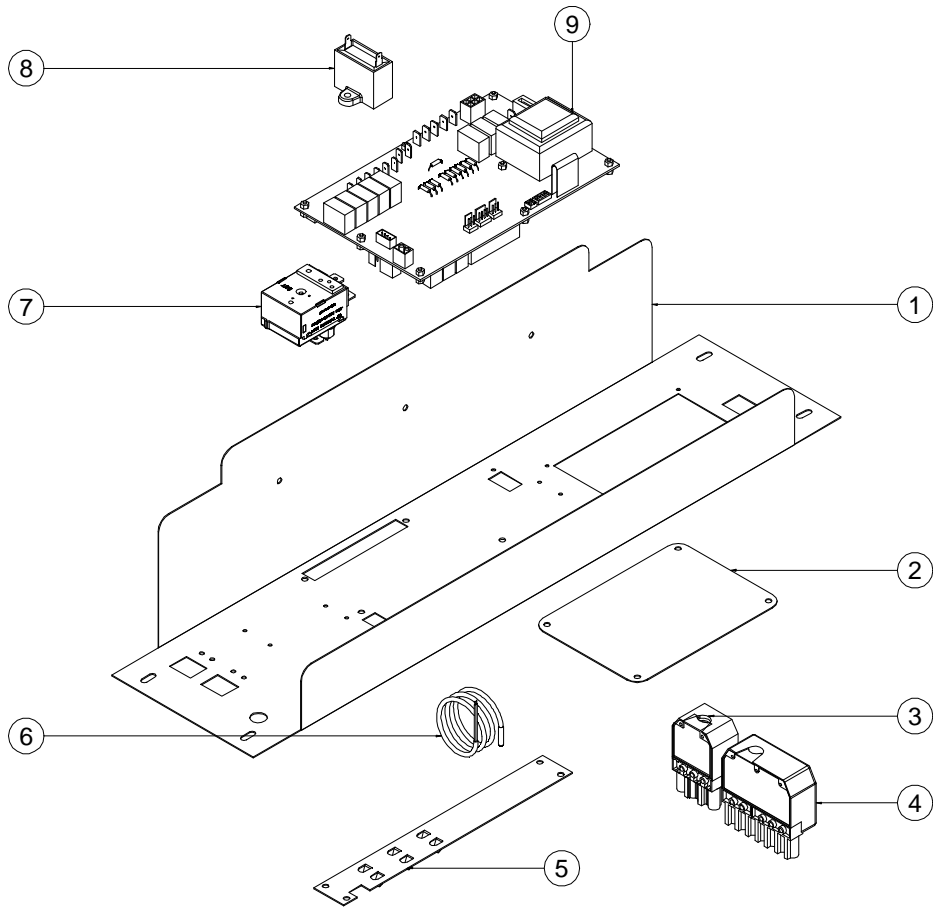

SELEDUA000

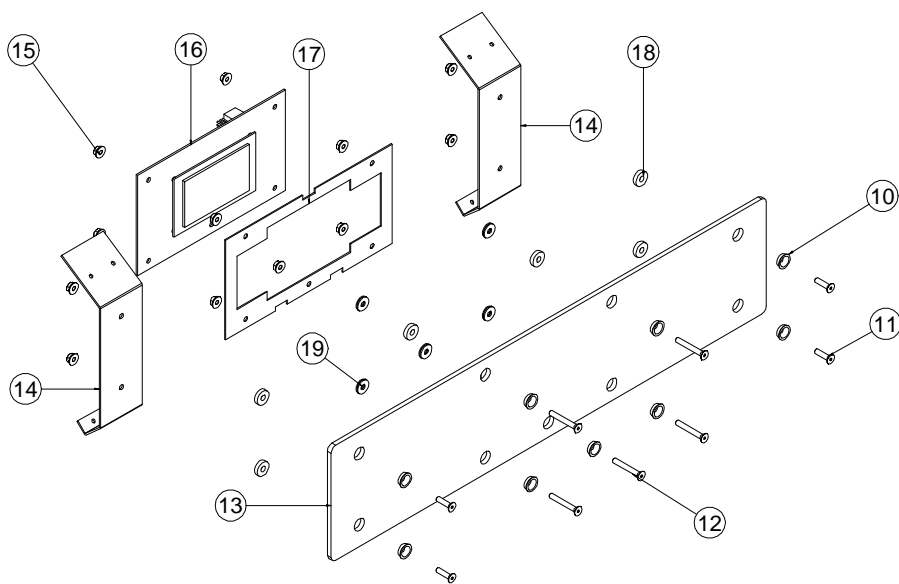

DualTherm

<u>No.</u>	<u>Code</u>	<u>Description</u>
1	SEPO002396	DUALTHERM cabinet
2	SEPO002333	Cover
3	CELC000304	4-pole female connector (inputs)
4	CQUE000041	7-pole female connector (outputs)
5	SCHA009150	Ground plate
6	CELC000234	Evolution probe
7	CELC000022	Safety thermostat 100°C
8	CFOV000133	Fan condenser (2x10 ⁻⁶ F)
9	REBI462200	CCDPE boiler control card
10	CTOE000015	M4 countersunk coupling <i>PL/625-P</i>
11	CTOR000155	DIN-7991 Allen plane cab. screw
12	CTOR000158	DIN-7991 M4x30 Allen plane cab. screw
13	COTR000063	BIOCLASS NG glass
14	SCHA011869	Front fastening
15	CTOR000089	Hex nut with DIN-6923 washer
16	REBI471200	DUALTHERM CCDPF display card
17	SCHA009564	Display bracket
18	CFER000064	Nylon washer
19	CTOR000132	DIN-9021 flat washer

Door

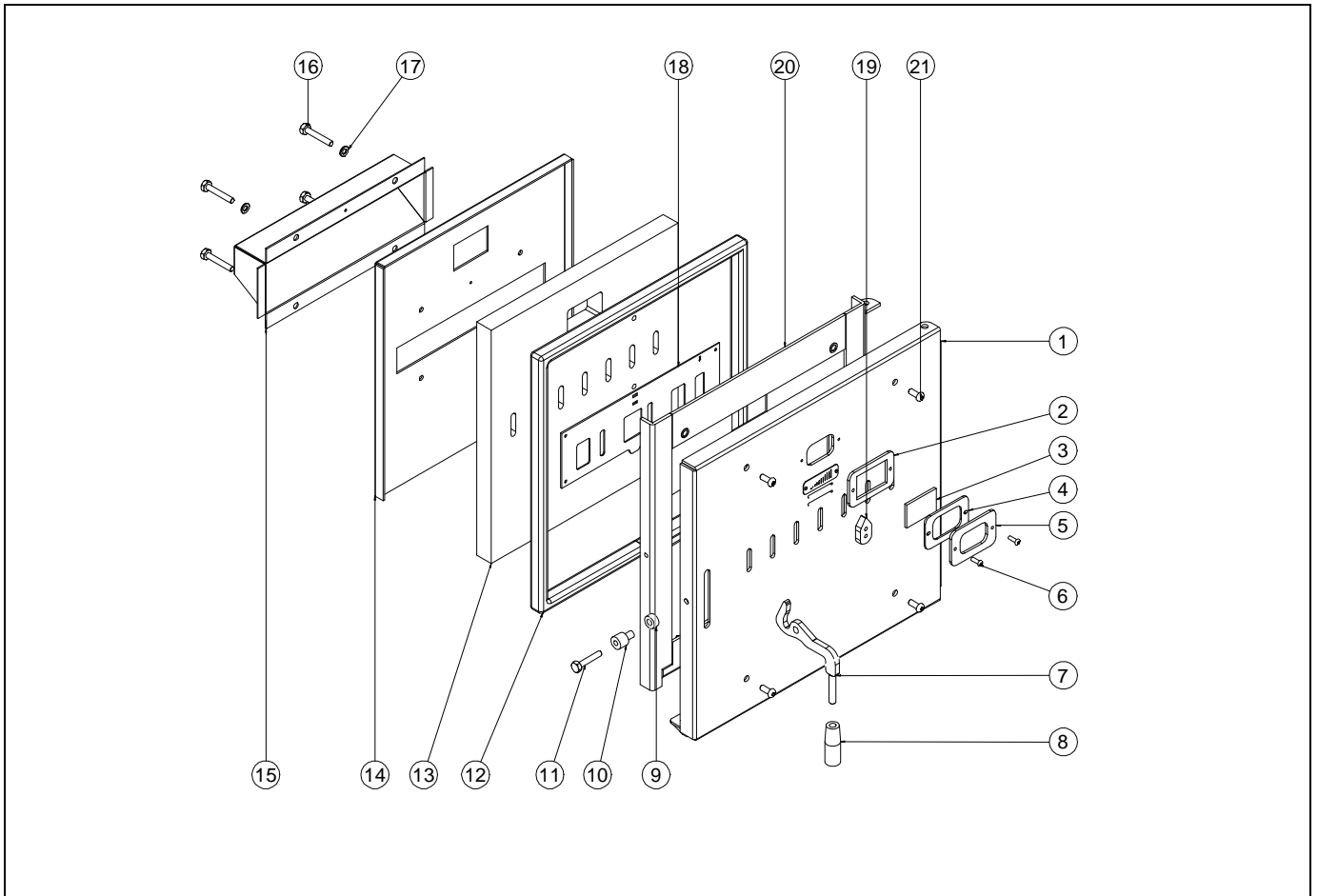

No.	Code	Description
1	SEPO002426	DUALTHERM door
2	SEPO002427	Spyhole buffer
3	COTR000072	Spyhole glass
4	CAIS000017	Spyhole joint
5	SEPO002428	Spyhole cover
6	CTOR000285	M5x16 blued Allen screw
7	SCHA011349	DUALTHERM door handle
8	CFER000302	M10 round knob
9	CFER000297	Boiler door bushing
10	CFER000298	Boiler door bushing 1
11	CTOR000287	Hex. cab screw DIN-933 M8x45
12	SAIS000184	20mm ceramic braid
13	CAIS000014	Ceramic plate
14	SCHA011460	Ceramic plate holder
15	SCHA011619	Secondary housing
16	CTOR000277	Hex. cab. screw DIN-933 M8x50 stainless steel
17	CTOR000250	DIN-125 M8 flat washer.
18	SEPO002429	Rack
19	SEPO002430	Door ventilation handle
20	SEPO002917	Base of the ceramic plate
21	CTOR000298	M8x20 blued Allen screw
	RCON000955	Door

DualTherm

Wiring

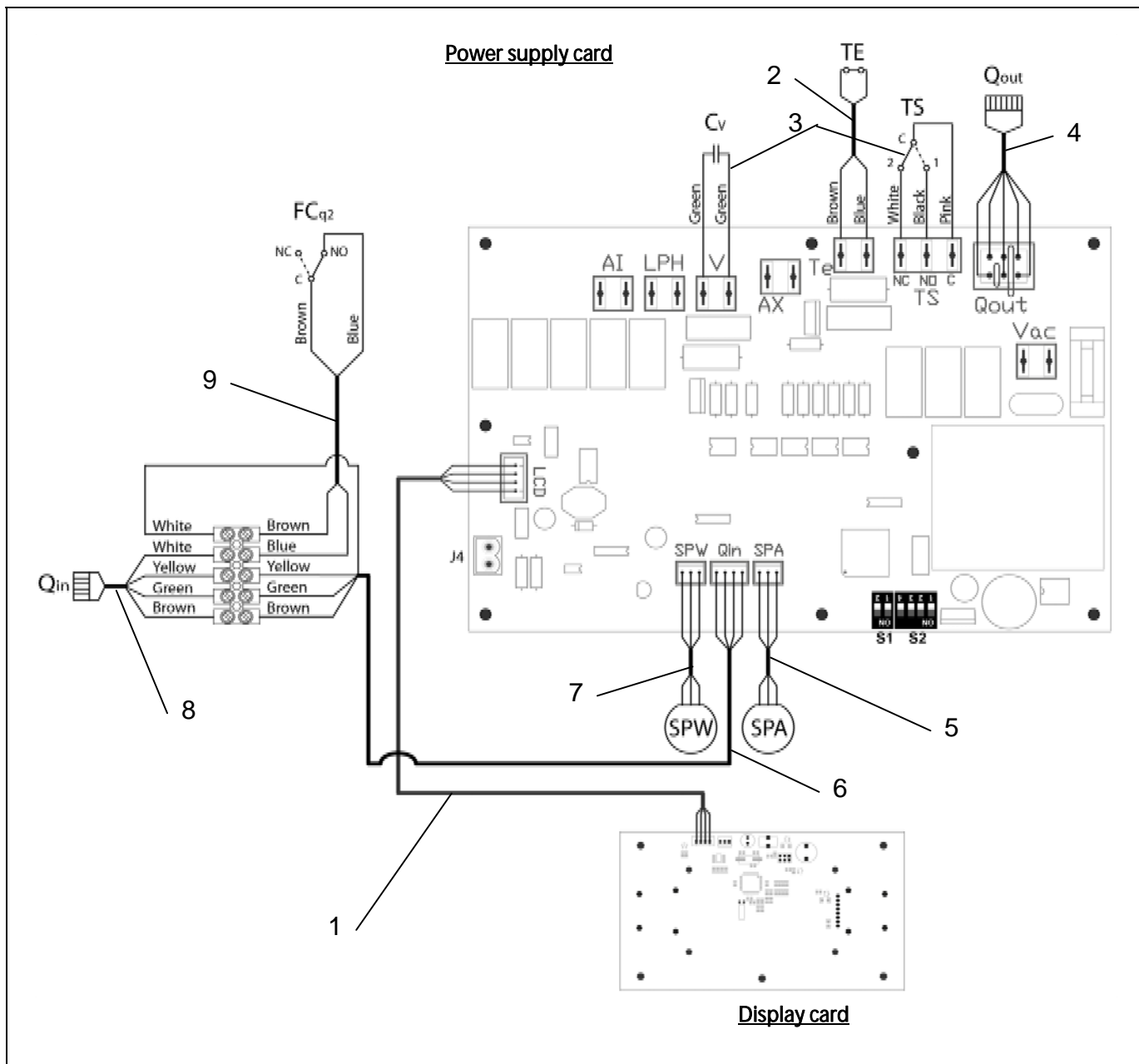

Nº.	Code	Name
1	CELC000343	Communication cable
2	CELC000353	Thermostat cable
3	CMAZ000123	Wiring harness
4	CELC000344	Burner output cable
5	CELC000348	Air pressure sensor cable
6	CELC000467	Short burner inlet hose
7	CELC000349	Water pressure sensor cable
8	CELC000468	Long burner inlet hose
9	CELC000465	Door limit switch hose

34 ALARM CODES

DualTherm boiler is equipped with an electronic controller that performs continuous self-testing to detect any boiler malfunctioning. When it detects a functioning error, this is indicated by an alarm code on the display. The table below shows the list of the alarm codes:

CODE	ALARM	DESCRIPTION
E-01	Boiler temperature sensor open circuit, S_c .	The boiler sensor is damaged or disconnected. Contact your nearest official technical assistance service to have it replaced.
E-02	Boiler temperature sensor short-circuited, S_c .	
E-03	DHW temperature sensor open circuit, S_a .	The DHW sensor is damaged or disconnected. Contact your nearest official technical assistance service to have it replaced.
E-04	DHW temperature sensor short-circuited, S_a .	
E-05	Overheating in fuel entrance tube, Te .	The security thermostat of fuel entrance tube has exceeded the safety temperature of 80 °C. The boiler will lock out. To unlock the boiler wait the temperature drops, press the button on the safety thermostat and restore by pressing RESET button. If this alarm occurs repeatedly contact the nearest official technical assistance service.
E-06	Ignition failure.	Check the fuel content in the hopper or calibrate the feed auger. If this alarm occurs repeatedly contact the nearest official technical assistance service.
E-07	Burner ash cleaning system start step error.	These alarms occur when a bad running of the burner ash cleaning system is detected. If this alarm occurs repeatedly contact the nearest official technical assistance service.
E-08	Burner ash cleaning system final step error.	
E-09	Burner ash cleaning system switch error, FC_p .	
E-10	Boiler water overheating.	The water in the boiler has exceeded the safety temperature of 100 °C. The boiler will lock out. The boiler will be unlocked automatically when the boiler temperature drops below 90 °C. If this alarm occurs repeatedly contact the nearest official technical assistance service.
E-11	Safety thermostat, T_s .	The water in the boiler has exceeded the safety temperature of 110 °C. The boiler will cut out.. To unlock it, wait until the boiler drops below 100 °C and press the button on the safety thermostat. If this alarm occurs repeatedly contact the nearest official technical assistance service.
E-12	Burner switch, FC_q .	This error can appear only in "combustion mode I" and could be because the burner is not correctly fitted to the boiler or the door of the combustion chamber has been opened. If this alarm occurs repeatedly contact the nearest official technical assistance service.
E-13	Insufficient air depression.	Check the correct running and connection of the air pressure sensor and that the burner and ashtray are correctly fitted to the boiler. If this alarm occurs repeatedly contact the nearest official technical assistance service.
E-14	Air depression fall down.	
E-15	Insufficient air depression during ignition pre-purge step.	
E-18	Water pressure sensor fault.	The water pressure sensor is damaged or disconnected. Contact your nearest official technical assistance service to have it replaced.

DualTherm

CODE	ALARM	DESCRIPTION
E-19	Low water pressure.	The pressure of water in the installation drops below the minimum pressure set at P.19 parameter of the " <i>Technical Menu</i> " (by default 0,5 bar). The boiler will lock out. To unlock it, fill the installation again up to 1 - 1.5 bar. This alarm occurs when the water is drained from the installation, due to either leakage or maintenance operations. If this alarm occurs repeatedly contact the nearest official technical assistance service.
E-20	Safety valve fault.	When the installation pressure exceeds 3.5 bar, this alarm is displayed on the screen. The safety valve is damaged or it doesn't work properly. The boiler will lock out. The boiler will be unlocked, when the pressure drops below 2,5 bar again. Drain the installation up to 1 - 1.5 bar. Contact your nearest official technical assistance service to have it replaced.
E-21	Air pressure sensor fault.	The air pressure sensor is damaged or disconnected. Contact your nearest official technical assistance service to have it replaced.
E-22	Excessive air depression in the combustion chamber.	The air depression measured in the combustion chamber exceeds the limits of the air pressure sensor. The burner will be locked until the depression is correct again. If this alarm occurs repeatedly contact the nearest official technical assistance service.
E-23	Excessive air overpressure in the combustion chamber.	The air overpressure measured in the combustion chamber exceeds the limits of the air pressure sensor. The burner will be locked until the depression is correct again. If this alarm occurs repeatedly contact the nearest official technical assistance service.
E-25	Wrong calibration data.	The calibration data is wrong or it is set at OFF value. If this alarm occurs repeatedly contact the nearest official technical assistance service.
E-26	Communication error with CVS Suction System .	Communication failure between boiler and CVS Suction System. The kit will lock out. When the communication is restored CVS Suction System will be unlocked. If this alarm occurs repeatedly contact the nearest official technical assistance service.
E-27	CVS Suction System blockage.	If the level sensor continues to detect no fuel after 8 consecutive cycles, CVS Suction System will lock out. To unlock it press RESET button. If this alarm occurs repeatedly contact the nearest official technical assistance service.
E-28	Overpressure of water.	When the boiler water pressure exceeds 2.5 bar, this alarm is displayed on the screen to warn of an excess of pressure in the installation. To restore the normal functioning of the boiler it is recommended to drain the installation again up to 1 - 1.5 bar If this alarm occurs repeatedly contact the nearest official technical assistance service.
E-29	Fuel level sensor error.	Fuel level sensor is damaged or disconnected. Contact your nearest official technical assistance service to have it replaced.
E-30	Underfloor temperature sensor open circuit, Sr1 .	Underfloor temperature sensor is damaged or disconnected. Contact your nearest official technical assistance service to have it replaced.
E-31	Underfloor temperature sensor short-circuited, Sr1 .	

CODE	ALARM	DESCRIPTION
E-32	Underfloor temperature sensor open circuit, Sr2 .	Underfloor temperature sensor is damaged or disconnected. Contact your nearest official technical assistance service to have it replaced.
E-33	Underfloor temperature sensor short-circuited, Sr2 .	
E-34	Outdoor temperature sensor open circuit, Sext .	Outdoor temperature sensor is damaged or disconnected. Contact your nearest official technical assistance service to have it replaced.
E-35	Outdoor temperature sensor short-circuited, Sext .	
E-36	DIP-switch wrongly changed.	DIP-switch selector of the boiler is changed when the boiler is connected to the main supply. The boiler will be locked out until unplug and plug the boiler again.
E-37	Communication error with BIO Hydraulic Kit .	Communication failure between boiler and the BIO Hydraulic Kit . If this alarm occurs repeatedly contact the nearest official technical assistance service.
E-38	Lasting insufficient air depression during ignition pre-purge step.	Check the air pressure sensor and that the burner and ashtray are correctly fitted to the boiler. If this alarm occurs repeatedly contact the nearest official technical assistance service.
E-39	Insufficient fan speed.	Fan malfunction. If this alarm occurs repeatedly contact the nearest official technical assistance service.
E-40	Fan speed fall down.	
E-41	Lasting fan speed fall down.	
E-42	Communication error with BIO Hydraulic Kit .	Communication failure between boiler and the BIO Hydraulic Kit . If this alarm occurs repeatedly contact the nearest official technical assistance service.
E-44	Boiler Maintenance.	Notice for maintenance of the boiler. Contact your nearest official technical assistance service to perform periodic maintenance of the boiler.
E-45	BT tank temperature sensor open circuit, Sbt .	BT tank temperature sensor is damaged or disconnected. Contact your nearest official technical assistance service to have it replaced.
E-46	BT tank temperature sensor short-circuited, Sbt .	
E-47	Communication error with pellets level sensing unit.	Communication failure between boiler and the pellets sensing system board (PCB). If this alarm occurs repeatedly contact the nearest official technical assistance service.
E-48	Low fuel level in the hopper.	Warning that the hopper is going to run out of pellets (fuel reserve). The boiler will continue operate normally. Refill the hopper with pellets up to the sensor to restore the warning alarm.
E-49	Hopper is run out of fuel.	The hopper is completely empty of pellets. The boiler stops running to avoid emptying the auger. To restore boiler functioning refill the hopper with pellets up to the sensor and press RESET button.
E-50	CVS Suction System and pellets sensing units connected together.	CVS Suction System and pellets sensing units are connected together to boiler's main board. Contact your nearest official technical assistance service to disconnect one of the units.

DualTherm

CODE	ALARM	DESCRIPTION
E-52	Excess fume temperature, Sh .	The temperature of the fumes has exceeded the safety temperature. Check the dirt of the smoke passages. To unlock the alarm, press the RESET button on the boiler handle. If this alarm occurs repeatedly, you should contact the nearest official Technical Assistance Service.
E-53	Insufficient air depressure with firewood	Check the correct operation and connection of the air pressure sensor and that the burner and ash drawer are correctly placed in the boiler. If this alarm occurs repeatedly, you should contact the nearest official Technical Assistance Service.
E-54	Error in the connexion of fume sensor, Sh	The fume sensor is badly connected (reverse polarity). This error could be also because the temperature of CCDPE card is very low. Operation will only be permitted in the "Pellet Only" Combustion Mode 1. If this alarm appear constantly contact with your nearest official Technical Assistance Service to have it replaced.
E-55	Open circuit, Sh fume sensor	The fume sensor is damaged or disconnected. Operation will only be permitted in the "Pellet Only" Combustion Mode 1. If this alarm appear constantly contact with your nearest official Technical Assistance Service to have it replaced.

DOMUSA

TEKNIK

MAILING ADDRESS

Apartado 95
20730 AZPEITIA
Tel: (+34) 943 813 899

HEADQUARTERS & FACTORY

B° San Esteban s/n
20737 RÉGIL (Guipúzcoa)

www.domusateknik.com

DOMUSA TEKNIK reserves the right to make modifications of any kind to its product characteristics without prior notice.



CDOC001597

03/18