

Temperature Difference Controller TDC 3

Installation and operating instructions

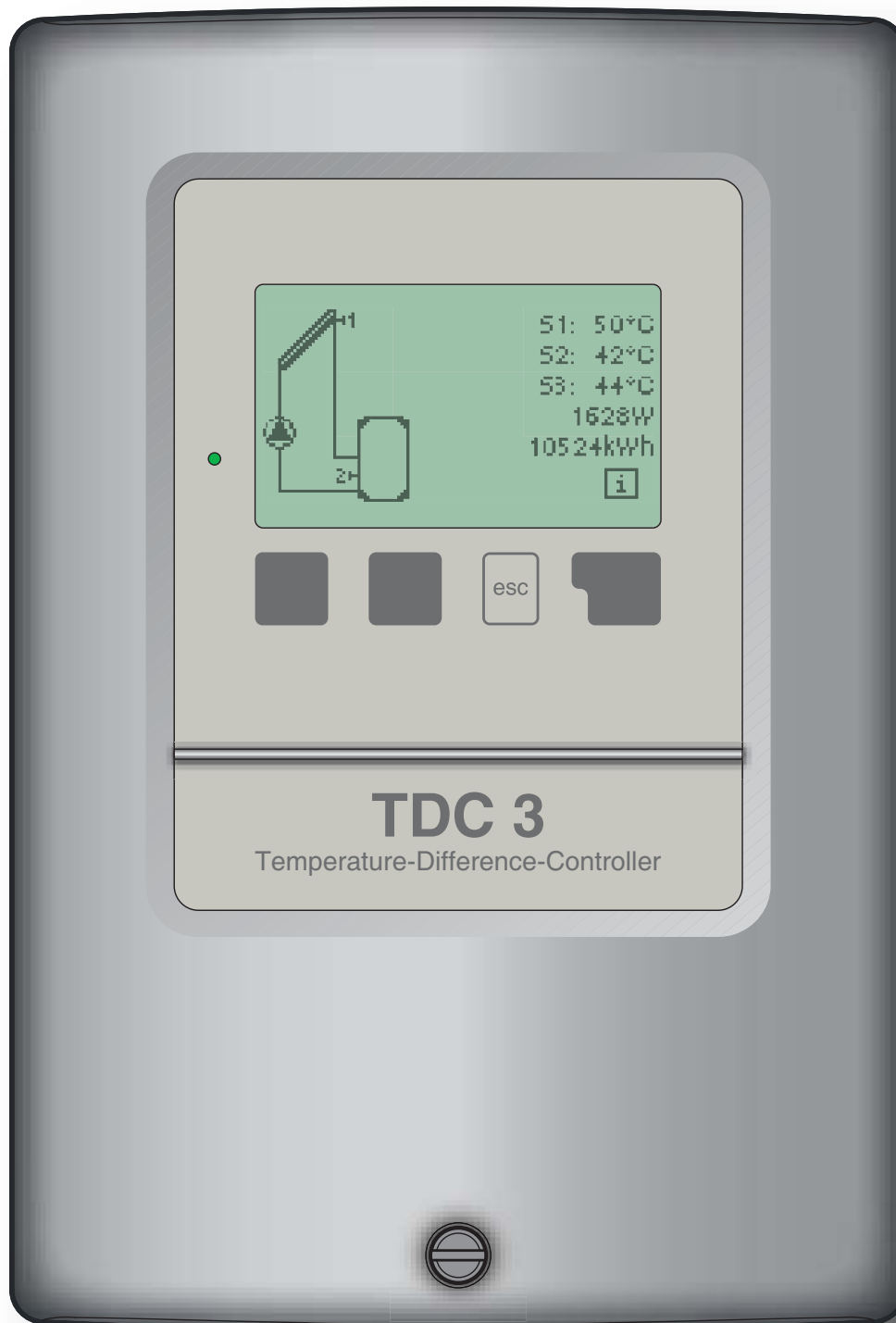

Read carefully before installation, commissioning and operation

Content

A.1	EC declaration of conformity	3	5.	Settings	29
A.2	General instructions	3	5.1	Tmin S1	29
A.3	Explanation of symbols	3	5.2	Tmin S2	29
A.4	Changes to the unit	4	5.3	Tmin S3	29
A.5	Warranty and liability	4	5.4	Tmax S2	30
			5.5	Tmax S3	30
B.1	Specifications	5	5.6	ΔT R1	30
B.2	About the controller	6	5.7	ΔT R2	31
B.3	Scope of supply	6	5.8	Tset S3	31
B.4	Disposal and pollutants	6	5.9	Hysteresis	31
B.5	Hydraulic variants	7	5.10	Priority sensor	32
			5.11	T priority	32
C.1	Wall installation	8	5.12	Loading time	32
C.2	Electrical connection	9	5.13	Increase	32
C.3	Installing the temperature sensors	10	5.14	Thermostat periods	32
			5.15	„Party Function“	33
D	Terminal connection diagrams	11	5.16	Energy saving mode	33
			5.17	TecoS3	33
E.1	Display and input	22	5.18	Table: Programs (hydraulic variants) with asso-	
E.2	Commissioning help	23		ciated settings	34
E.3	Free commissioning	23			
E.4	Menu sequence and menu structure	24	6.	Protective functions	35
			6.1	Seizing protection	35
1.	Measurement values	25	6.2	Frost protection	35
			6.3	System protection	36
2.	Statistics	26	6.4	Collector protection	36
2.1	Operating hours	26	6.4.1	Cooling functions	37
2.2	Average temperature difference ΔT	26	6.5	Col.- Alarm	37
2.3	Heat output	26	6.6	Recooling	37
2.4	Graphic overview	26	6.7	Anti-Legionella	38
2.5	Message log	26			
2.6	Reset/clear	26	7.	Special functions	39
			7.1	Program selections	39
3.	Display mode	27	7.2	Time & date	39
3.1	Schematic	27	7.3	Sensor calibration	39
3.2	Overview	27	7.4	Commissioning	40
3.3	Alternating	27	7.5	Factory settings	40
			7.6	Expansions	40
4.	Operating modes	28	7.7	Heat quantity	40
4.1	Automatic	28	7.8	Start aid function	41
4.2	Manual	28	7.9	Speed control	42
4.3	Off	28	7.9.1	Variant	42
4.4	Fill system	28	7.9.2	Purging time	43
			7.9.3	Sweep time	43
			7.9.4	Max. speed	43
			7.9.5	Min. speed	43
			7.9.6	Setpoint	43
			8.	Menu lock	44
			10.	Language	44
			9.	Service values	45
			Z.1.	Malfunctions with error messages	46
			Z.2.	Replacing the fuse	47
			Z.3.	Maintenance	47

Safety instructions

A.1 EC declaration of conformity

By affixing the CE mark to the unit the manufacturer declares that the Temperature-Difference-Controller 3, hereinafter referred to as TDC 3, conforms to the following relevant safety regulations:

- EC low voltage directive
73/23/EEC, as amended by 93/68/EEC
- EC electromagnetic compatibility directive
89/336/EEC version 92/31/EEC version 93/68/EEC

Conformity has been verified and the corresponding documentation and the EC declaration of conformity are kept on file by the manufacturer.

A.2 General instructions

It is essential that you read this!

These installation and operating instructions contain basic instructions and important information regarding safety, installation, commissioning, maintenance and the optimal use of the unit. Therefore these instructions must be read completely and understood by the installation technician/specialist and by the system user before installation, commissioning and operation of the unit.

The valid accident prevention regulations, VDE regulations, the regulations of the local power utility, the applicable DIN-EN standards and the installation and operating instruction of the additional system components must also be observed. The controller does not under any circumstances replace any safety devices to be provided by the customer!

Installation, electrical connection, commissioning and maintenance of the unit may only be carried out by specialists who possess the appropriate training.

For the user: Make sure that the specialist gives you detailed information on the function and operation of the controller. Always keep these instructions in the vicinity of the controller.

A.3 Explanation of symbols



Failure to observe these instructions can result in danger to life from electric voltage.



Failure to observe these instructions can result in serious damage to health such as scalding, or even life-threatening injuries.



Failure to observe these instructions can result in destruction of the unit or the system, or damage to the environment.



Information which is especially important for the function and optimal use of the unit and the system.

Safety instructions

A.4 Changes to the unit



Changes to the unit can compromise the safety and function of the unit or the entire system.

- Changes, additions to or conversion of the unit are not permitted without the written permission from the manufacturer
- It is likewise forbidden to install additional components that have not been tested together with the unit
- If it becomes clear that safe operation of the unit is no longer possible, for example because of damage to the housing, then turn the controller off immediately
- Any parts of the unit or accessories that are not in perfect condition must be exchanged immediately
- Use only original spare parts and accessories from the manufacturer.
- Markings made on the unit at the factory must not be altered, removed or made illegible
- Only the settings actually described in these instructions may be made on the controller

A.5 Warranty and liability

The controller has been manufactured and tested with regard to high quality and safety requirements. The unit is subject to the statutory guarantee period of two years from the date of sale.

The warranty and liability shall not include, however, any injury to persons or material damage that is attributable to one or more of the following causes:

- Failure to observe these installation and operating instructions
- Improper installation, commissioning, maintenance and operation
- Improperly executed repairs
- Unauthorised structural changes to the unit
- Installation of additional components that have not been tested together with the unit
- Any damage resulting from continued use of the unit despite an obvious defect
- Failure to use original spare parts and accessories
- Use of the device for other than its intended purpose
- Operation above or below the limit values listed in the specifications
- Force majeure

Description of controller

B.1 Specifications

Electrical specifications:

Mains voltage	230VAC +/- 10%
Mains frequency	50...60Hz
Power consumption	2VA
Switched power	
Electronic relay R1	min.20W...max.120W for AC3
Mechanical relay R2	460VA for AC1 / 185W for AC3
Internal fuse	2A slow-blow 250V
Protection category	IP40
Protection class	II
Sensor inputs	3 x Pt1000
Measuring range	-40°C up to 300°C

Permissible ambient conditions:

Ambient temperature	
for controller operation	0°C...40°C
for transport/storage	0°C...60°C
Air humidity	
for controller operation	max. 85% rel. humidity at 25°C
for transport/storage	no moisture condensation permitted

Other specifications and dimensions

Housing design	2-part, ABS plastic
Installation methods	Wall installation, optionally panel installation
Overall dimensions	163mm x 110mm x 52mm
Aperture installation dimensions	157mm x 106mm x 31mm
Display	Fully graphical display, 128 x 64 dots
Light diode	Multicolour
Operation	4 entry keys

Temperature sensors:

Collector or boiler sensor	Pt1000, e.g. immersion sensor TT/S2 up to 180°C
Storage tank sensor	Pt1000, e.g. immersion sensor TT/P4 up to 95°C
Pipe-mounted sensor	Pt1000, e.g. pipe-mounted sensor TR/P4 up to 95°C
Sensor leads	2x0.75mm ² extendable up to 30m max.

Temperature resistance table for Pt1000 sensors

°C	0	10	20	30	40	50	60	70	80	90	100
Ω	1000	1039	1077	1116	1155	1194	1232	1270	1308	1347	1385

Description of controller

B.2 About the controller

The Temperature Difference Controller TDC 3 facilitates efficient use and function control of your solar or heating system. The device is impressive most of all for its functionality and simple, almost self-explanatory operation. For each step in the input process the individual entry keys are assigned to appropriate functions and explained. The controller menu contains headwords for the measured values and settings, as well as help texts or clearly-structured graphics.

The TDC 3 can be used as a temperature difference controller for the various system variants illustrated and explained under B.5.

Important characteristics of the TDC 3:

- Depiction of graphics and texts in a lighted display
- Simple viewing of the current measurement values
- Analysis and monitoring of the system by means of statistical graphics, etc.
- Extensive setting menus with explanations
- Menu block can be activated to prevent unintentional setting changes
- Resetting to factory settings
- A wide range of additional functions are available.

B.3 Scope of supply

- Temperature Difference Controller TDC 3
- 3 screws 3,5x35mm and 3 plugs 6mm for wall installation
- 6 strain relief clips with 12 screws, replacement fuse 2A slow-blow
- Installation and operating instructions TDC 3

Optionally contained depending on design/order:

- 2-3 PT1000 temperature sensors and immersion sleeves

Additionally available:

- Pt1000 temperature sensor, immersion sleeves, overvoltage protection,
- Various additional functions by means of supplementary circuit boards

B.4 Disposal and pollutants

The unit conforms to the European RoHS directive 2002/95/EC for the restriction of the use of certain hazardous substances in electrical and electronic equipment.



The unit must not under any circumstances be disposed of with ordinary household refuse. Dispose of the unit only at appropriate collection points or ship it back to the seller or manufacturer.

Description of controller

B.5 Hydraulic variants



The following illustrations should be viewed only as schematic diagrams showing the respective hydraulic systems, and do not claim to be complete. The controller does not replace safety devices under any circumstances. Depending on the specific application, additional system components and safety components may be mandatory, such as check valves, non-return valves, safety temperature limiters, scalding protectors, etc., and must therefore be provided.

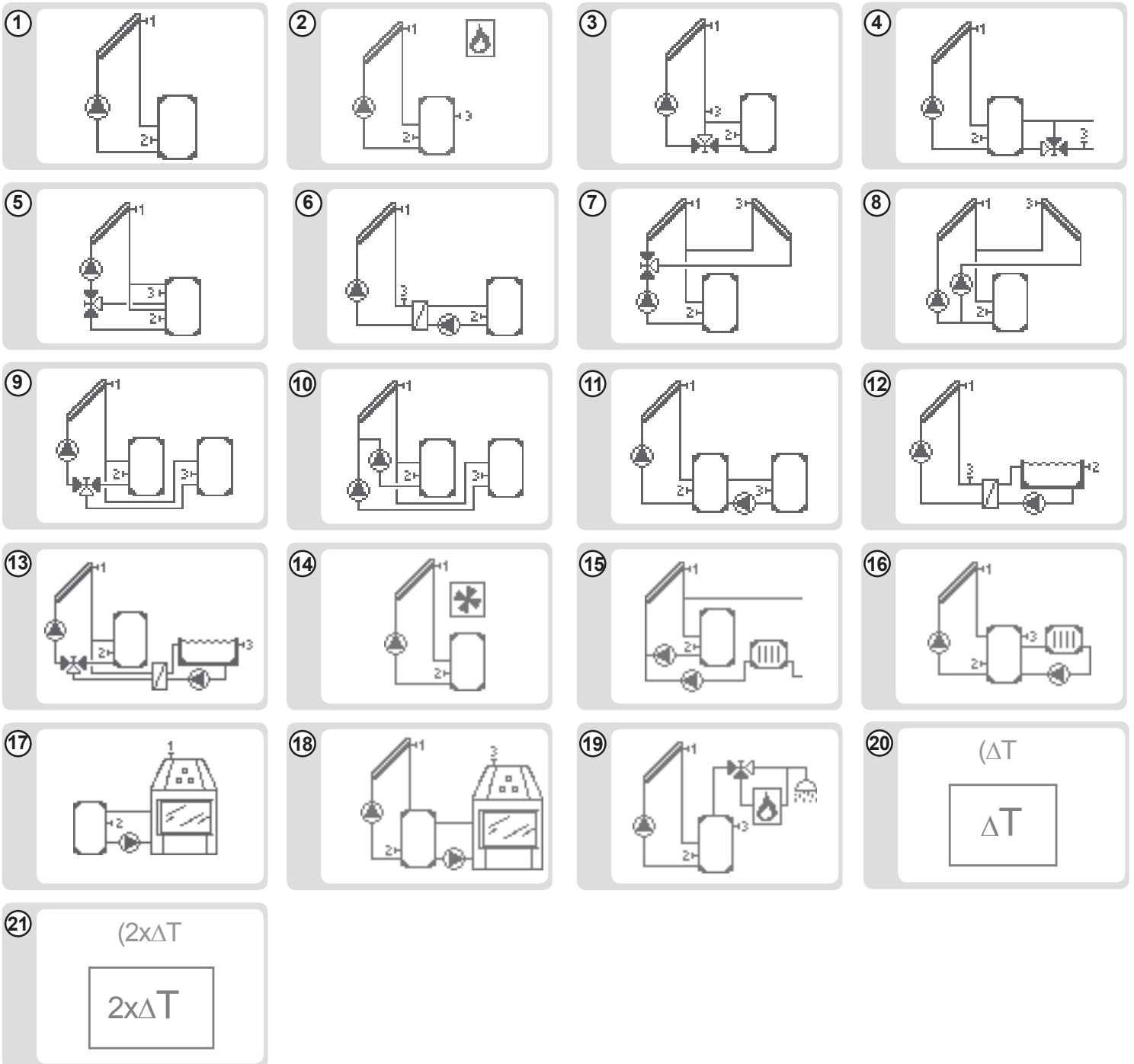

Installation

C.1 Wall installation



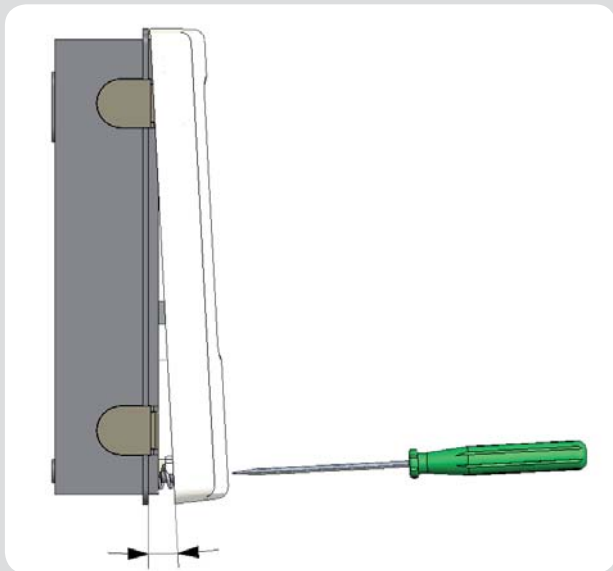

Install the controller only in dry areas and under the ambient conditions described under B.1 "Specifications". Carry out the following steps 1-8.

C.1.1



1. Unscrew cover screw completely
2. Carefully pull upper part of housing from lower part.
3. Set upper part of housing aside, being sure not to touch the electronics when doing so.
4. Hold the lower part of the housing up to the selected position and mark the 3 mounting holes. Make sure that the wall surface is as even as possible so that the housing does not become distorted when it is screwed on.

C.1.2

 3x 3,5 x 30
 3x Ø6

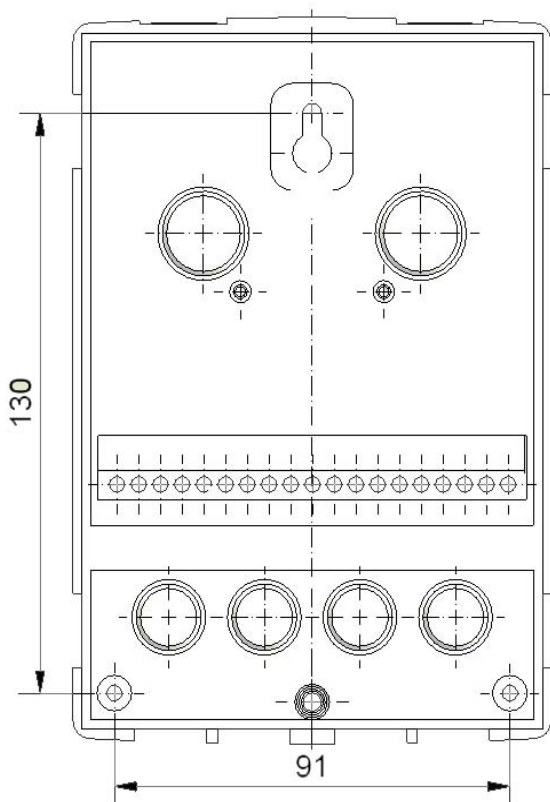

5. Using a drill and size 6 bit, drill 3 holes at the points marked on the wall and push in the plugs.
6. Insert the upper screw and screw it in slightly.
7. Fit the upper part of the housing and insert the other two screws.
8. Align the housing and tighten the three screws.

Installation

C.2 Electrical connection



Danger

Before working on the unit, switch off the power supply and secure it against being switched on again! Check for the absence of power! Electrical connections may only be made by a specialist and in compliance with the applicable regulations.

Do not use the controller if the housing shows visible damage.



Caution

Low-voltage cables such as temperature sensor cables must be routed separately from mains voltage cables. Feed temperature sensor cables only into the left-hand side of the unit, and mains voltage cables only into the right-hand side.



Caution

The customer must provide an all-pole disconnecting device, e.g. a heating emergency switch.



Caution

The cables being connected to the unit must not be stripped by more than 55mm, and the cable jacket must reach into the housing just to the other side of the strain relief.



Caution

Relay R1 is only suitable for standard pumps (20-120VA) which are speed-controlled via the controller. The internal wiring of the controller is such that residual currents flow over relay R1 even in the rest condition. Therefore under no circumstances may valves, contactors or other consumers with low power consumption be operated on this output.



Caution

With hydraulic variant D1 „Solar+storage“ relays R1 and R2 are switched on simultaneously to allow the connection of another load at R2.

Installation

C.2.1

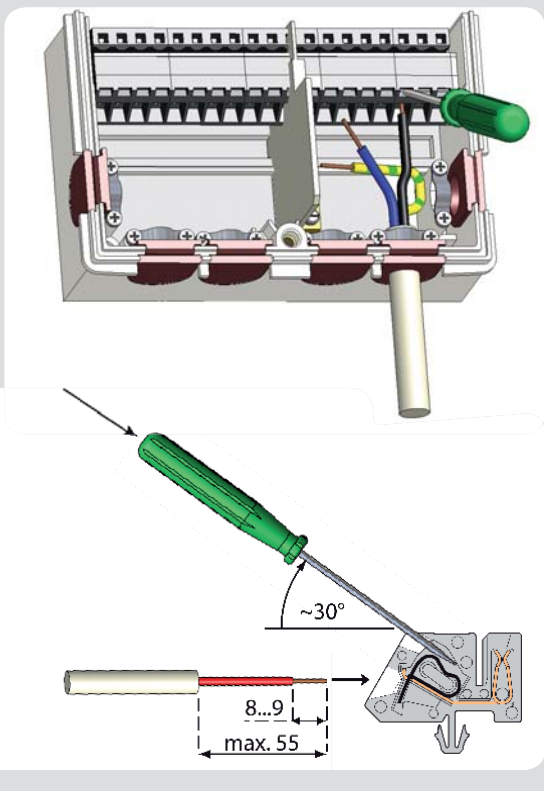

1. Select necessary program/hydraulics (Fig. B5 resp. D.1 - D.20)
2. Open controller as described under C.1.
3. Strip cables by 55mm max., insert, fit the strain relief devices, strip the last 8-9mm of the wires (Fig. C.2.1)
4. Open the terminals using a suitable screwdriver (Fig. C.2.1) and make electrical connections on the controller (s. D.1 - D.20)
5. Refit upper part of housing and fasten with screw.
6. Switch on mains voltage and place controller in operation.

C.3 Installing the temperature sensors

The controller operates with Pt1000 temperature sensors which are accurate to the degree, thus ensuring optimal control of system functions.



Caution

If desired the sensor cables can be extended to a maximum of 30m using a cable with a cross-section of at least 0.75mm². Make sure that there is no contact resistance!

Position the sensor precisely in the area to be measured!

Only use immersion, pipe-mounted or flat-mounted sensor suitable for the specific area of application with the appropriate permissible temperature range.



Caution

The temperature sensor cables must be routed separately from mains voltage cables, and must not, for example, be routed in the same cable duct!

Installation

D Terminal connection diagrams

D.1 Solar with storage tank

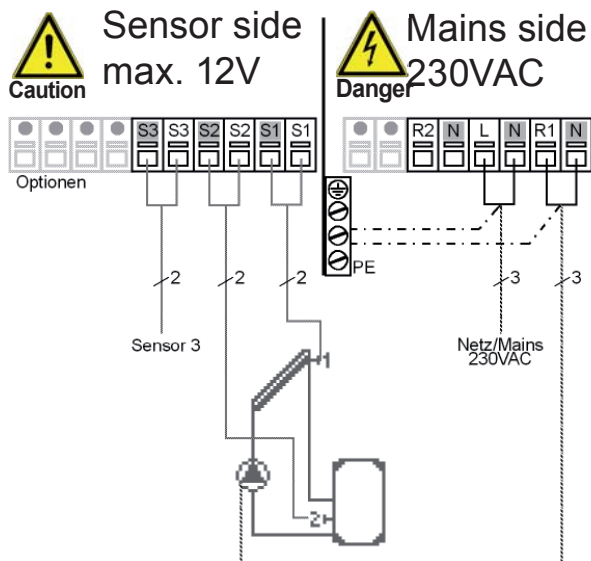

Relay R1 and R2 are both switched on in this variant, so e.g. a pump can be connected to R2.



Caution

Relay R1: For speed control of standard pumps, minimum load 20VA

Low voltage max. 12VAC/DC connection in the left-hand terminal compartment!

Terminal: Connection for:

- S1 (2x) Sensor 1 collector
- S2 (2x) Sensor 2 storage tank
- S3 (2x) Sensor 3 (optional)

The polarity of the sensors is freely selectable.

Mains voltages 230VAC 50-60Hz Connection in the right-hand terminal compartment!

Terminal: Connection for:

- L Mains phase conductor L
- N Mains neutral conductor N
- R1 Pump L (speed)
- N Pump N
- R2 Pump L (no speed)
- N Pump N

The PE protective conductor must be connected to the PE metal terminal block!

D.2 Solar + Thermostat

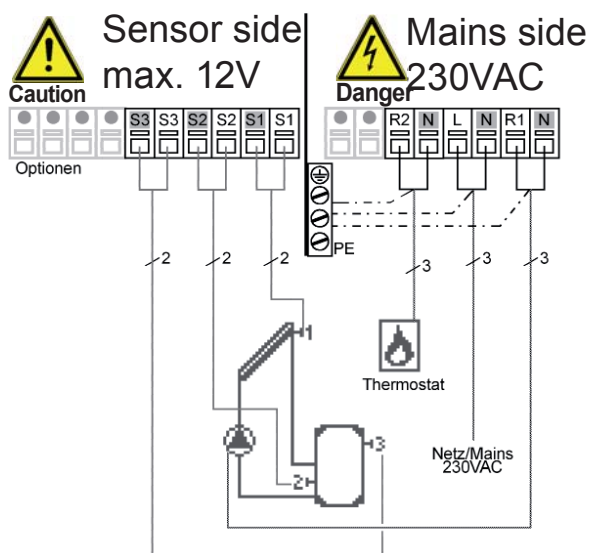

Caution

Relay R1: For speed control of standard pumps, minimum load 20VA

Low voltage max. 12VAC/DC connection in the left-hand terminal compartment!

Terminal: Connection for:

- S1 (2x) Sensor 1 collector
- S2 (2x) Sensor 2 storage tank low
- S3 (2x) Sensor 3 storage tank top

The polarity of the sensors is freely selectable.

Mains voltages 230VAC 50-60Hz Connection in the right-hand terminal compartment!

Terminal: Connection for:

- L Mains phase conductor L
- N Mains neutral conductor N
- R1 Pump L (speed)
- N Pump N
- R2 Thermostat function L
- N Thermostat function N

The PE protective conductor must be connected to the PE metal terminal block!

Installation

D.3 Solar with bypass

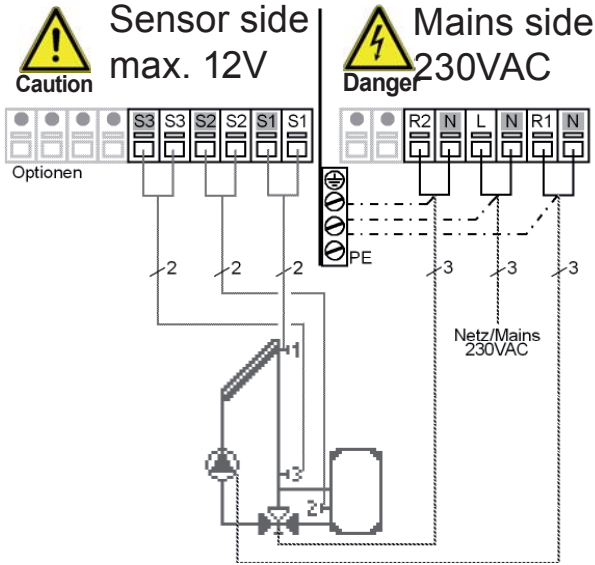

Actuating direction of valve:
R2 on/valve on = bypass without storage tank charging



Relay R1: For speed control of standard pumps, minimum load 20VA

Low voltage max. 12VAC/DC connection in the left-hand terminal compartment!

Terminal: **Connection for:**
S1 (2x) Sensor 1 collector
S2 (2x) Sensor 2 storage tank
S3 (2x) Sensor 3 forward flow
The polarity of the sensors is freely selectable.

Mains voltages 230VAC 50-60Hz Connection in the right-hand terminal compartment!

Terminal: **Connection for:**
L Mains phase conductor L
N Mains neutral conductor N
R1 Pump L (speed)
N Pump N
R2 Phase valve L
N Bypass valve N

The PE protective conductor must be connected to the PE metal terminal block!

D.4 Solar with return lift

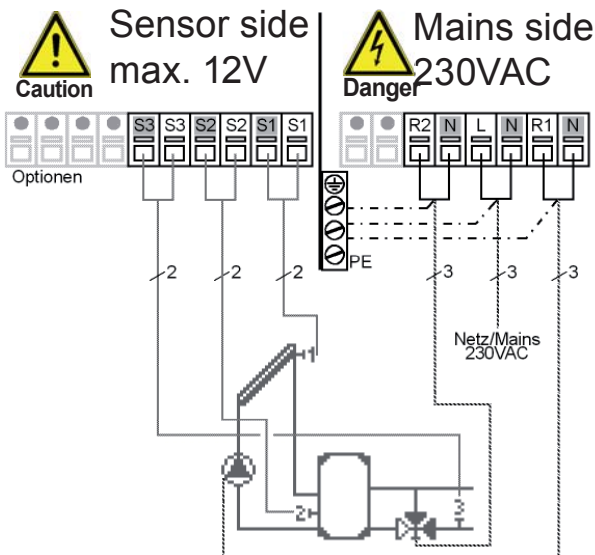

Actuating direction of valve:
R2 on/valve on = path through the storage tank



Relay R1: For speed control of standard pumps, minimum load 20VA

Low voltage max. 12VAC/DC connection in the left-hand terminal compartment!

Terminal: **Connection for:**
S1 (2x) Sensor 1 collector
S2 (2x) Sensor 2 storage tank
S3 (2x) Sensor 3 heating circuit return
The polarity of the sensors is freely selectable.

Mains voltages 230VAC 50-60Hz Connection in the right-hand terminal compartment!

Terminal: **Connection for:**
L Mains phase conductor L
N Mains neutral conductor N
R1 Pump L (speed)
N Pump N
R2 Valve L
N Valve N

The PE protective conductor must be connected to the PE metal terminal block!

Installation

D.5 Solar with 2 zone storage tanks

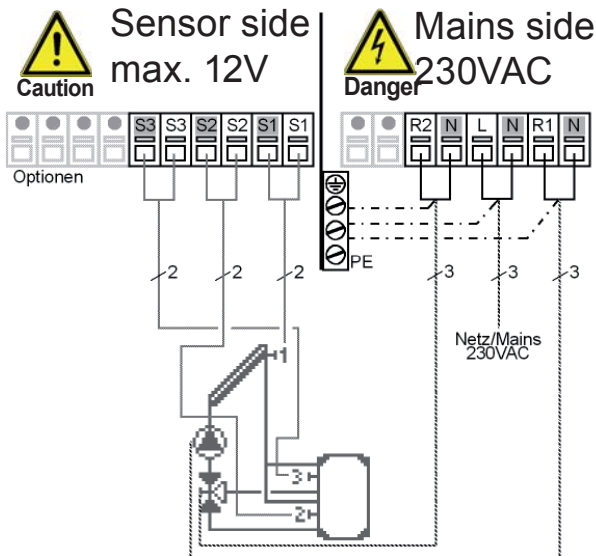

Actuating direction of valve:
R2 on/valve on = charge to sensor 3
(storage tank above)

Caution Relay R1: For speed control of standard pumps, minimum load 20VA

Low voltage max. 12VAC/DC connection in the left-hand terminal compartment!

Terminal: Connection for:
S1 (2x) Sensor 1 collector
S2 (2x) Sensor 2 storage tank low
S3 (2x) Sensor 3 storage tank top
The polarity of the sensors is freely selectable.

Mains voltages 230VAC 50-60Hz Connection in the right-hand terminal compartment!

Terminal: Connection for:
L Mains phase conductor L
N Mains neutral conductor N
R1 Pump L (speed)
N Pump N
R2 Zone valve L
N Zone valve N

The PE protective conductor must be connected to the PE metal terminal block!

D.6 Solar with ext. heat exchanger

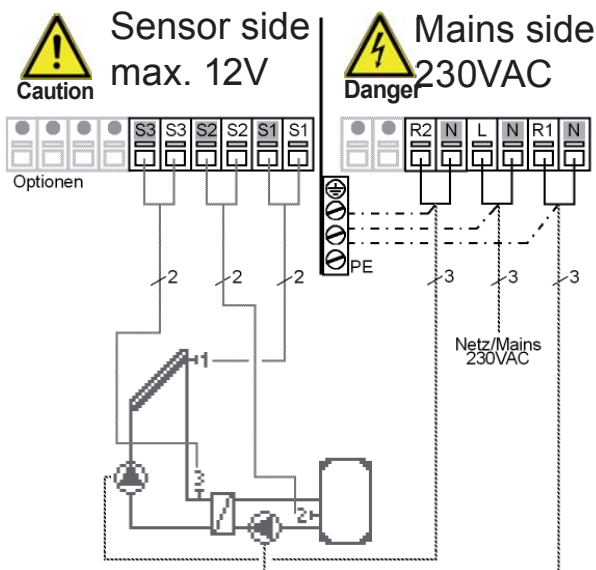

Caution Relay R1: For speed control of standard pumps, minimum load 20VA

Low voltage max. 12VAC/DC connection in the left-hand terminal compartment!

Terminal: Connection for:
S1 (2x) Sensor 1 collector
S2 (2x) Sensor 2 storage tank
S3 (2x) Sensor 3 forward flow
The polarity of the sensors is freely selectable.

Mains voltages 230VAC 50-60Hz Connection in the right-hand terminal compartment!

Terminal: Connection for:
L Mains phase conductor L
N Mains neutral conductor N
R1 Pump, secondary L (speed)
N Pump, secondary N
R2 Pump, primary L
N Pump, primary N

The PE protective conductor must be connected to the PE metal terminal block!

Installation

D.7 Solar 2 coll. (east/west)

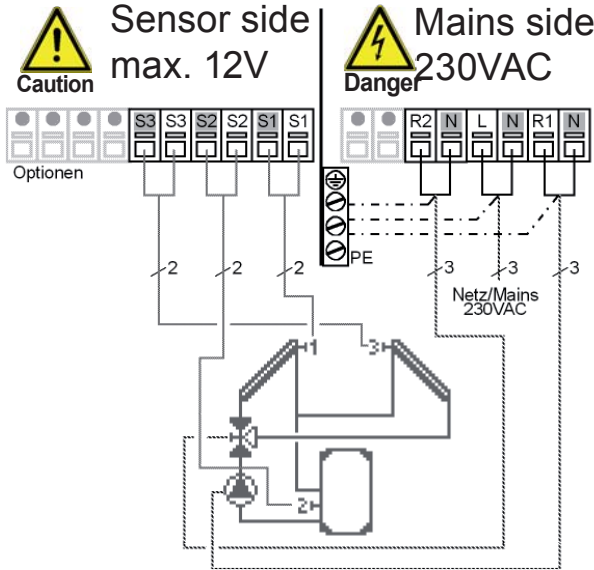

Actuating direction of valve:
R2 on/valve on = collector with flow through sensor 3



Relay R1: For speed control of standard pumps, minimum load 20VA

Caution

Low voltage max. 12VAC/DC connection in the left-hand terminal compartment!

Terminal: Connection for:

S1 (2x) Sensor 1 collector 1

S2 (2x) Sensor 2 storage tank

S3 (2x) Sensor 3 collector 2

The polarity of the sensors is freely selectable.

Mains voltages 230VAC 50-60Hz Connection in the right-hand terminal compartment!

Terminal: Connection for:

L Mains phase conductor L

N Mains neutral conductor N

R1 Pump L (speed)

N Pump N

R2 Change-over valve L

N Change-over valve N

The PE protective conductor must be connected to the PE metal terminal block!

D.8 Solar 2 coll. 2 pumps

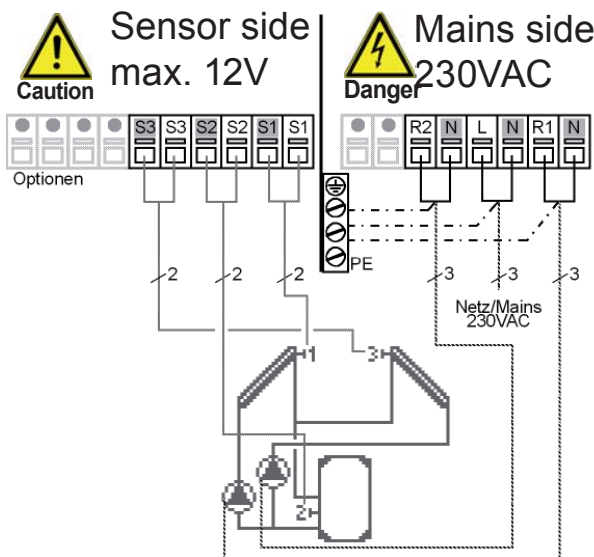

Relay R1: For speed control of standard pumps, minimum load 20VA

Caution

Low voltage max. 12VAC/DC connection in the left-hand terminal compartment!

Terminal: Connection for:

S1 (2x) Sensor 1 collector 1

S2 (2x) Sensor 2 storage tank

S3 (2x) Sensor 3 collector 2

The polarity of the sensors is freely selectable.

Mains voltages 230VAC 50-60Hz Connection in the right-hand terminal compartment!

Terminal: Connection for:

L Mains phase conductor L

N Mains neutral conductor N

R1 Pump (coll. 1) L (speed)

N Pump (coll. 1) N

R2 Pump (coll. 2) L

N Pump (coll. 2) N

The PE protective conductor must be connected to the PE metal terminal block!

Installation

D.9 Solar 2 Storage tank/valve

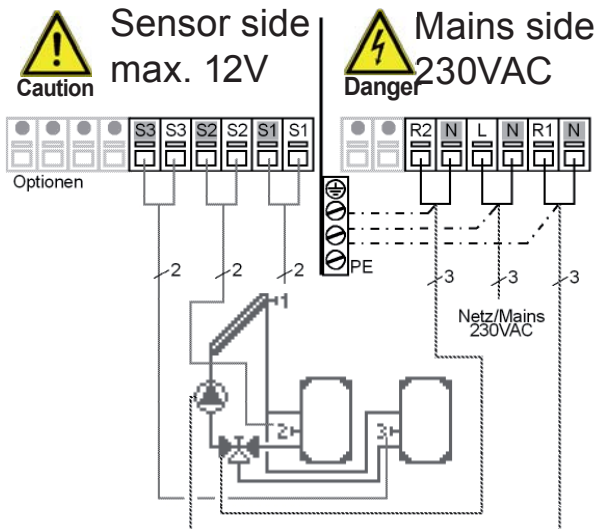

Actuating direction of valve:
R2 on/valve on = charge to sensor 3
(storage tank 2)

 Relay R1: For speed control of standard pumps, minimum load 20VA

Low voltage max. 12VAC/DC connection in the left-hand terminal compartment!

Terminal: Connection for:
S1 (2x) Sensor 1 collector
S2 (2x) Sensor 2 storage tank 1
S3 (2x) Sensor 3 storage tank 2
The polarity of the sensors is freely selectable.

Mains voltages 230VAC 50-60Hz Connection in the right-hand terminal compartment!

Terminal: Connection for:
L Mains phase conductor L
N Mains neutral conductor N
R1 Pump L (speed)
N Pump N
R2 Change-over valve L
N Change-over valve N
The PE protective conductor must be connected to the PE metal terminal block!

D.10 Solar 2 storage tank/2 pu.

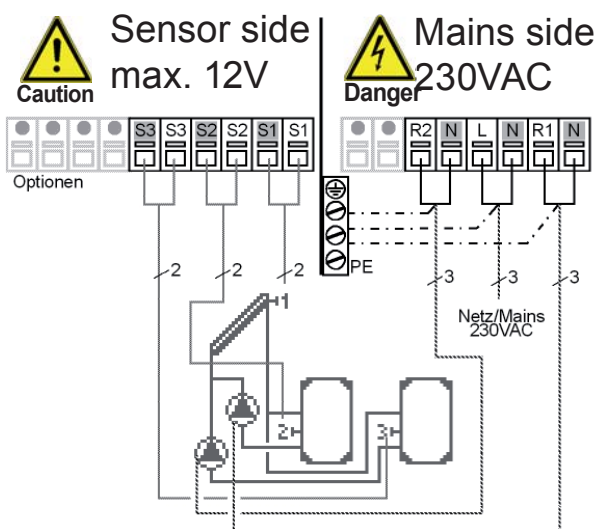

 Relay R1: For speed control of standard pumps, minimum load 20VA

Low voltage max. 12VAC/DC connection in the left-hand terminal compartment!

Terminal: Connection for:
S1 (2x) Sensor 1 collector
S2 (2x) Sensor 2 storage tank 1
S3 (2x) Sensor 3 storage tank 2
The polarity of the sensors is freely selectable.

Mains voltages 230VAC 50-60Hz Connection in the right-hand terminal compartment!

Terminal: Connection for:
L Mains phase conductor L
N Mains neutral conductor N
R1 Pump (St.1) L (speed)
N Pump (storage tank 1) N
R2 Pump (storage tank 2) L
N Pump (storage tank 2) N
The PE protective conductor must be connected to the PE metal terminal block!

Installation

D.11 Solar with follow-on storage tank/Solar & transfer

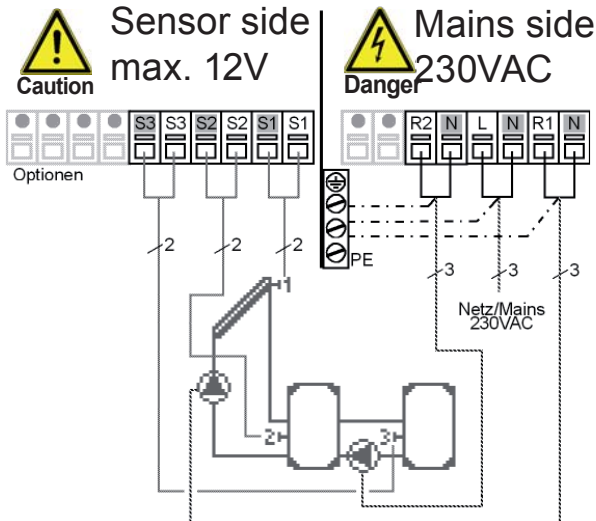

Caution Relay R1: For speed control of standard pumps, minimum load 20VA

Low voltage max. 12VAC/DC connection in the left-hand terminal compartment!

Terminal: **Connection for:**
 S1 (2x) Sensor 1 collector
 S2 (2x) Sensor 2 storage tank 1
 S3 (2x) Sensor 3 storage tank 2
 The polarity of the sensors is freely selectable.

Mains voltages 230VAC 50-60Hz Connection in the right-hand terminal compartment!

Terminal: **Connection for:**
 L Mains phase conductor L
 N Mains neutral conductor N
 R1 Pump L (speed)
 N Pump N
 R2 Pump (storage tank 2) L
 N Pump (storage tank 2) N

The PE protective conductor must be connected to the PE metal terminal block!

D.12 Solar with swimming pool and heat exchanger

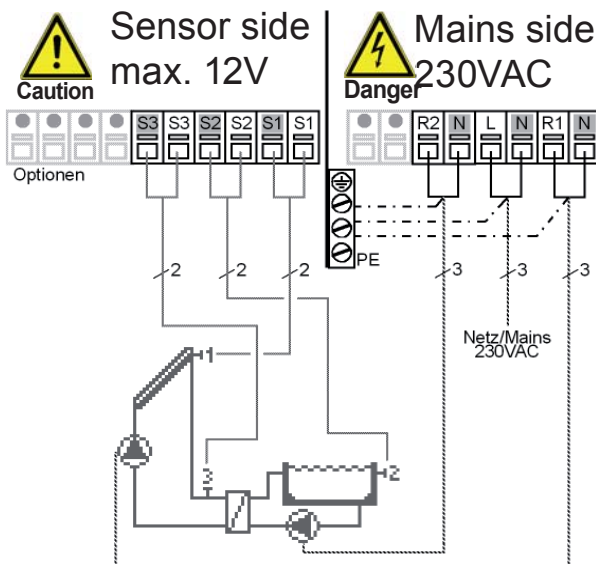

Caution Relay R1: For speed control of standard pumps, minimum load 20VA

Low voltage max. 12VAC/DC connection in the left-hand terminal compartment!

Terminal: **Connection for:**
 S1 (2x) Sensor 1 collector
 S2 (2x) Sensor 2 swimming pool
 S3 (2x) Sensor 3 forward flow
 The polarity of the sensors is freely selectable.

Mains voltages 230VAC 50-60Hz Connection in the right-hand terminal compartment!

Terminal: **Connection for:**
 L Mains phase conductor L
 N Mains neutral conductor N
 R1 Pump, prim. L (speed)
 N Pump, primary N
 R2 Pump, secondary L
 N Pump, secondary N

The PE protective conductor must be connected to the PE metal terminal block!

Installation

D.13 Solar storage tank/pool

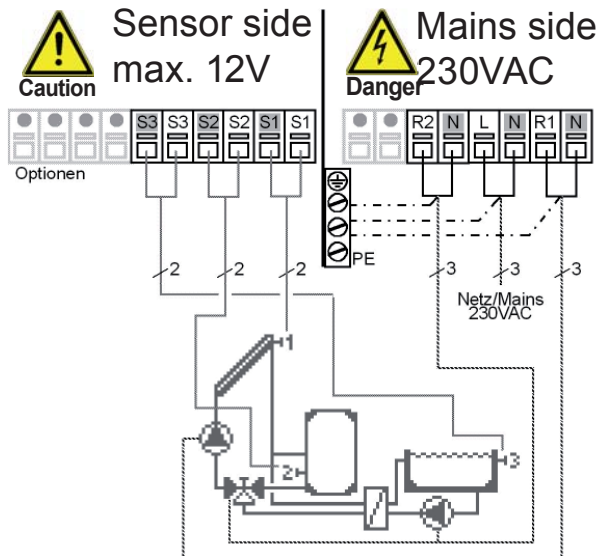

Actuating direction of valve:
R2 on/valve on = charge to sensor 3
(swimming pool)



Relay R1: For speed control of standard pumps, minimum load 20VA

Caution

Low voltage max. 12VAC/DC connection in the left-hand terminal compartment!

Terminal: Connection for:

S1 (2x) Sensor 1 collector
S2 (2x) Sensor 2 storage tank
S3 (2x) Sensor 3 swimming pool

The polarity of the sensors is freely selectable.

Mains voltages 230VAC 50-60Hz Connection in the right-hand terminal compartment!

Terminal: Connection for:

L Mains phase conductor L
N Mains neutral conductor N
R1 Pump L (speed)
N Pump N
R2 Pump (sec.)+valve L
N Pump (sec.)+valve N

The PE protective conductor must be connected to the PE metal terminal block!

D.14 Solar + cooling 1

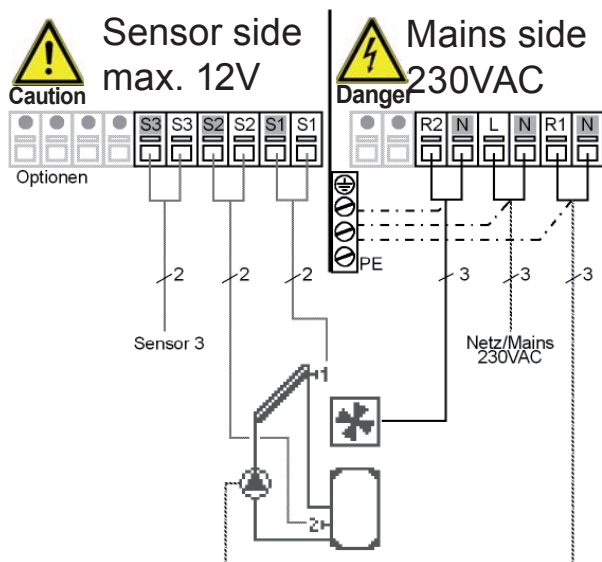

Description of cooling function see 6.4.1



Relay R1: For speed control of standard pumps, minimum load 20VA

Caution

Low voltage max. 12VAC/DC connection in the left-hand terminal compartment!

Terminal: Connection for:

S1 (2x) Sensor 1 collector
S2 (2x) Sensor 2 storage tank
S3 (2x) Sensor 3 (optional)

The polarity of the sensors is freely selectable.

Mains voltages 230VAC 50-60Hz Connection in the right-hand terminal compartment!

Terminal: Connection for:

L Mains phase conductor L
N Mains neutral conductor N
R1 Pump L (speed)
N Pump N
R2 Air cooler L
N Air cooler N

The PE protective conductor must be connected to the PE metal terminal block!

Installation

D.15 Solar + cooling 2

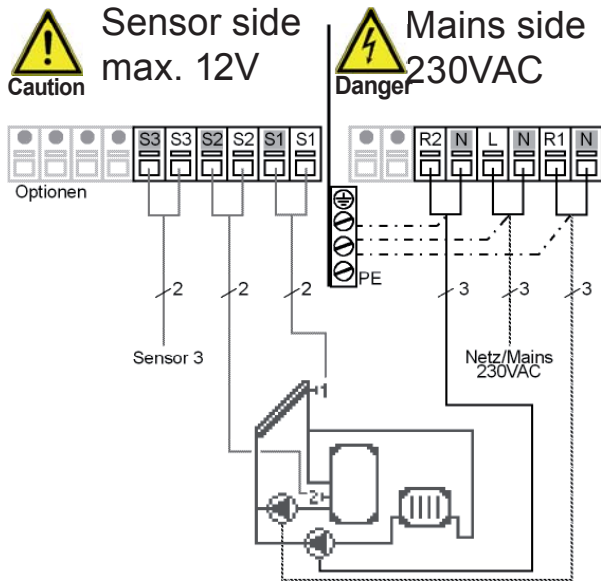

Description of cooling function see 6.4.1



Caution

Relay R1: For speed control of standard pumps, minimum load 20VA

Low voltage max. 12VAC/DC connection in the left-hand terminal compartment!

Terminal: Connection for:

- S1 (2x) Sensor 1 collector
- S2 (2x) Sensor 2 storage tank
- S3 (2x) Sensor 3 optional

The polarity of the sensors is freely selectable.

Mains voltages 230VAC 50-60Hz Connection in the right-hand terminal compartment!

Terminal: Connection for:

- L Mains phase conductor L
- N Mains neutral conductor N
- R1 Pump L (speed)
- N Pump N (speed)
- R2 Pump cooler L
- N Pump cooler N

The PE protective conductor must be connected to the PE metal terminal block!

D.16 Solar + cooling 3

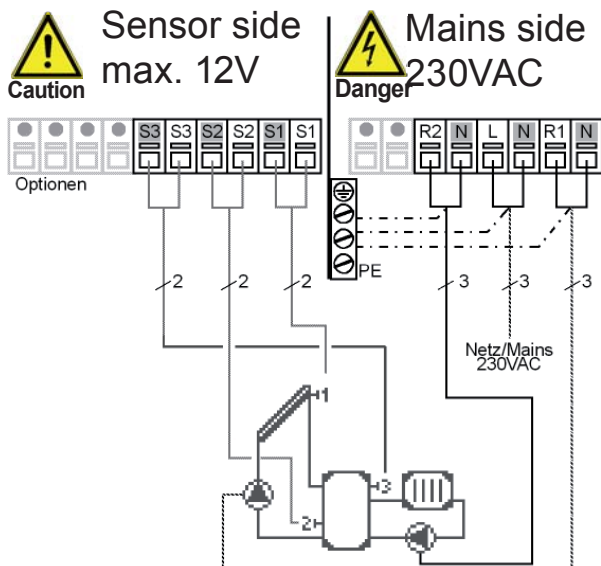

Description of cooling function see 6.4.1



Caution

Relay R1: For speed control of standard pumps, minimum load 20VA

Low voltage max. 12VAC/DC connection in the left-hand terminal compartment!

Terminal: Connection for:

- S1 (2x) Sensor 1 collector
- S2 (2x) Sensor 2 storage tank low
- S3 (2x) Sensor 3 storage tank top

The polarity of the sensors is freely selectable.

Mains voltages 230VAC 50-60Hz Connection in the right-hand terminal compartment!

Terminal: Connection for:

- L Mains phase conductor L
- N Mains neutral conductor N
- R1 Pump, prim. L (speed)
- N Pump, primary N (speed)
- R2 Pump cooler L
- N Pump cooler N

The PE protective conductor must be connected to the PE metal terminal block!

Installation

D.17 Solid fuel boiler

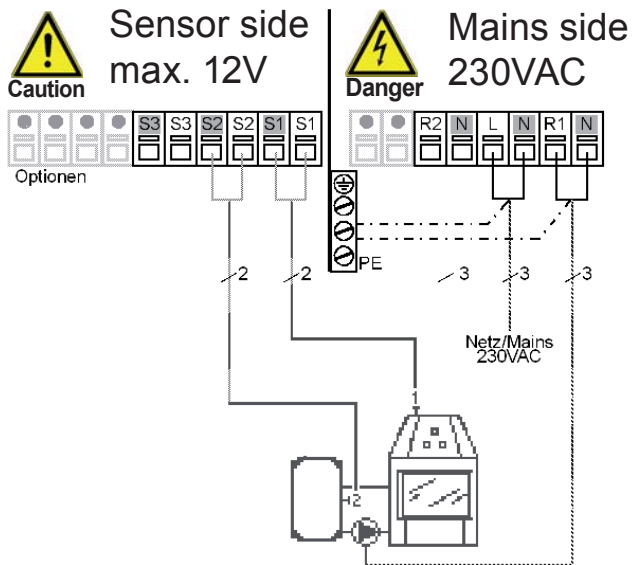

Relay R1: For speed control of standard pumps, minimum load 20VA

Low voltage max. 12VAC/DC connection in the left-hand terminal compartment!

Terminal: Connection for:

- S1 (2x) Fühler 1 solid fuel boiler
- S2 (2x) Fühler 2 storage tank
- S3 (2x) Fühler 3 (optional)

The polarity of the sensors is freely selectable.

Mains voltages 230VAC 50-60Hz Connection in the right-hand terminal compartment!

Terminal: Connection for:

- L Mains phase conductor L
- N Mains neutral conductor N
- R1 Pump L (speed)
- N Pump N (speed)
- R2 -
- N -

The PE protective conductor must be connected to the PE metal terminal block!

D.18 Solar + solid fuel boiler

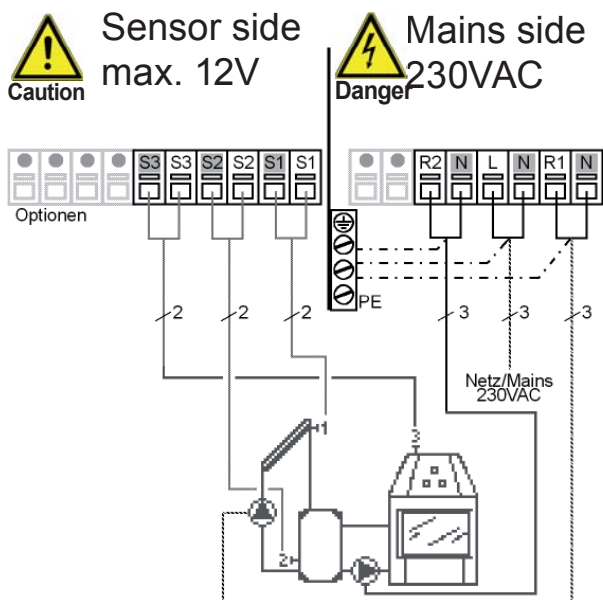

Relay R1: For speed control of standard pumps, minimum load 20VA

Low voltage max. 12VAC/DC connection in the left-hand terminal compartment!

Terminal: Connection for:

- S1 (2x) Sensor 1 collector
- S2 (2x) Sensor 2 storage tank
- S3 (2x) Sensor 3 solid fuel boiler

The polarity of the sensors is freely selectable.

Mains voltages 230VAC 50-60Hz Connection in the right-hand terminal compartment!

Terminal: Connection for:

- L Mains phase conductor L
- N Mains neutral conductor N
- R1 Pump L (speed)
- N Pump N (speed)
- R2 Pump solid fuel L
- N Pump solid fuel N

The PE protective conductor must be connected to the PE metal terminal block!

Installation

D.19 Solar + valve + thermostat

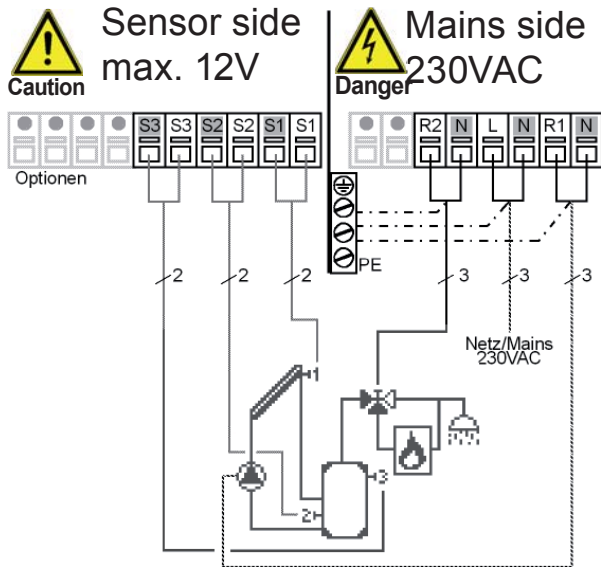

Relay R1: For speed control of standard pumps, minimum load 20VA

Low voltage max. 12VAC/DC connection in the left-hand terminal compartment!

Terminal: Connection for:
S1 (2x) Sensor 1 collector

S2 (2x) Sensor 2 storage tank low

S3 (2x) Sensor 3 storage tank top

The polarity of the sensors is freely selectable.

Mains voltages 230VAC 50-60Hz Connection in the right-hand terminal compartment!

Terminal: Connection for:
L Mains phase conductor L
N Mains neutral conductor N

R1 Pump L (speed)

N Pump N

R2 Valve L

N Valve N

The PE protective conductor must be connected to the PE metal terminal block!

D.20 Universal ΔT controller

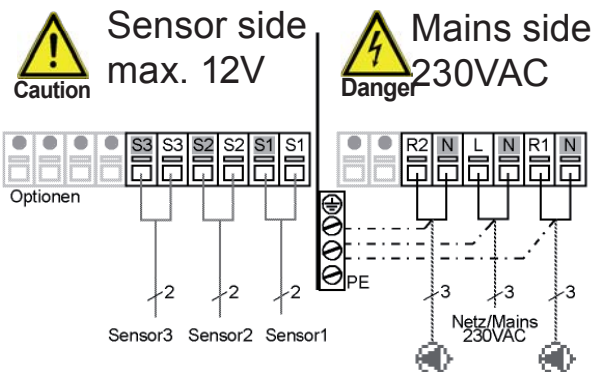

Relay R1: For speed control of standard pumps, minimum load 20VA

Low voltage max. 12VAC/DC connection in the left-hand terminal compartment!

Terminal: Connection for:
S1 (2x) Sensor 1 (control)

S2 (2x) Sensor 2 (reference)

S3 (2x) Sensor 3 (thermostat)

The polarity of the sensors is freely selectable.

Mains voltages 230VAC 50-60Hz Connection in the right-hand terminal compartment!

Terminal: Connection for:
L Mains phase conductor L
N Mains neutral conductor N

R1 Pump L (speed)

N Pump N

R2 e.g. pump L

N e.g. pump N

The PE protective conductor must be connected to the PE metal terminal block!

Installation

D.21 Universal 2x ΔT -controller

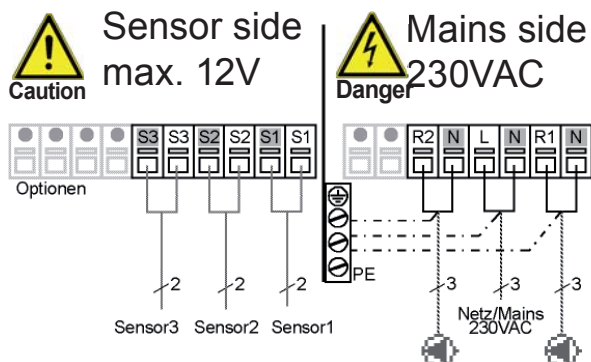

Brief description of switching function:

The ΔT function sensor 1 > sensor 2 switches the pump to relay R1.

The ΔT function 2 > sensor 3 switches the pump to relay R2.



Relay R1: For speed control of standard pumps, minimum load 20VA

Low voltage max. 12VAC/DC connection in the left-hand terminal compartment!

Terminal: Connection for:

S1 (2x) Sensor 1 (control)

S2 (2x) Sensor 2 (ref.+contr.)

S3 (2x) Sensor 3 (reference)

The polarity of the sensors is freely selectable.

Mains voltages 230VAC 50-60Hz Connection in the right-hand terminal compartment!

Terminal: Connection for:

L Mains phase conductor L

N Mains neutral conductor N

R1 Pump L (speed)

N Pump N

R2 e.g. pump L

N e.g. pump N

The PE protective conductor must be connected to the PE metal terminal block!

Operation

E.1 Display and input

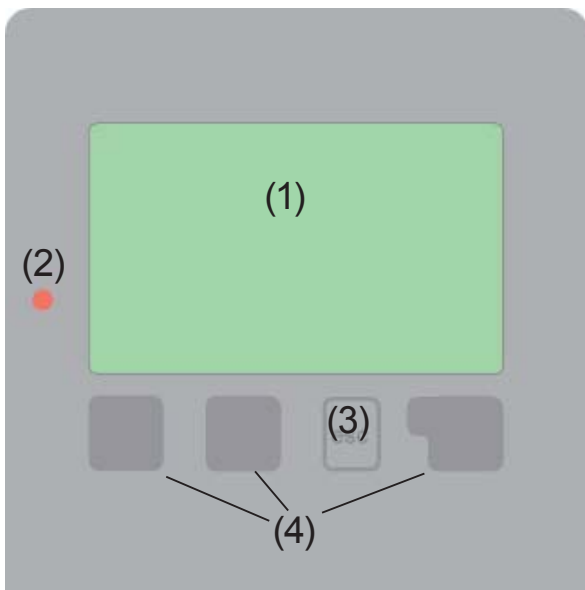

The display (1), with its extensive text and graphics mode, is almost self-explanatory, allowing easy operation of the controller.









The LED (2) lights up green when a relay is switched on.

The LED (2) lights up red when operating mode “Off” is set.

The LED (2) flashes slowly red in the operating mode “Manual”.

The LED (2) flashes quickly red when an error is present.

Examples of display symbols:

	Pump (rotates in operation)
	Valve (direction of flow black)
	Collector
	Storage tank
	Swimming pool
	Temperature sensor
	Heat exchanger
	Warning/error message
	New information available

Entries are made using four keys (3+4), which are assigned to different functions depending on the situation. The “esc” key (3) is used to cancel an entry or to exit a menu. If applicable there will be a request for confirmation as to whether the changes which have been made should be saved.

The function of each of the other three keys (4) is shown in the display line directly above the keys; the right-hand key is generally has a confirmation and selection function.

Examples of key functions:

+/-	= enlarge/shrink values
▼/▲	= scroll menu down/up
yes/no	= approve/reject
Info	= additional information
Back	= to previous screen
ok	= confirm selection
Confirm	= confirm setting

Parametrisation

E.2 Commissioning help



The first time the controller is turned on and after the language and time are set, a query appears as to whether you want to parametrise the controller using the commissioning help or not. The commissioning help can also be terminated or called up again at any time in the special functions menu. The commissioning help guides you through the necessary basic settings in the correct order, and provides

brief descriptions of each parameter in the display.

Pressing the “esc” key takes you back to the previous value so you can look at the selected setting again or adjust it if desired. Pressing the “esc” more than once takes you back step by step to the selection mode, thus cancelling the commissioning help. Finally, menu 4.2 under operating mode “Manual” should be used to test the switch outputs with the consumers connected, and to check the sensor values for plausibility. Then switch on automatic mode.



Observe the explanations for the the individual parameters on the following pages, and check whether further settings are necessary for your application.

E.3 Free commissioning

If you decide not to use the commissioning help, you should make the necessary settings in the following sequence:

- Menu 10. Language (see 14.)
- Menu 7.2 Time and date (see 12.2)
- Menu 7.1 Program selection (see 12.1)
- Menu 5. Settings, all values (see 10.)
- Menu 6. Protective functions if adaptations are necessary (see 11.)
- Menu 7. Special functions if additional changes are necessary (see 12.)

Finally, menu 4.2 under operating mode “Manual“ should be used to test the switch outputs with the consumers connected, and to check the sensor values for plausibility. Then switch on automatic mode.



Observe the explanations for the the individual parameters on the following pages, and check whether further settings are necessary for your application.

Operation

E.4 Menu sequence and menu structure

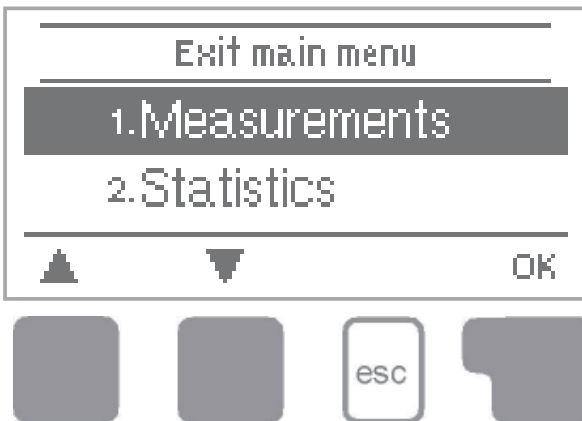
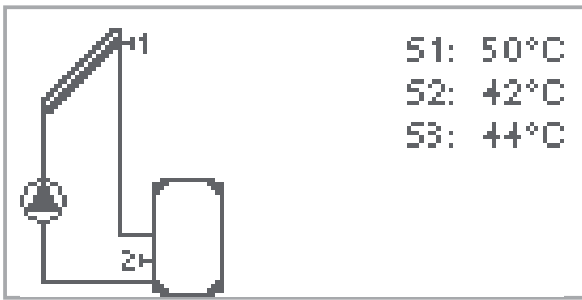

The graphics or overview mode appears when no key has been press for 2 minutes, or when the main menu is exited by pressing “esc”.

Pressing a key in graphics or overview mode takes you directly to the main menu. The following menu items are then available for selection there:

1. Measurements

Current temperature values with explanations

2. Statistics

Function control of the system with operating hours, etc

3. Display Mode

Select graphics mode or overview mode

4. Operating Mode

Automatic mode, manual mode or switch unit off

5. Settings

Set parameters needed for normal operation

6. Protections

Solar and frost protection, recooling, anti-seizing protection

7. Special functions

Program selection, sensor calibration, clock, additional sensor, etc.

8. Menu lock

Against unintentional setting changes at critical points

9. Service data

For diagnosis in the event of an error

10. Language

Language selection

Measurement values

1. Measurement values



The menu “1. Measurement values” serves to display the currently measured temperatures.

The menu is closed by pressing “esc” or selecting “Exit measurement values”.



Selecting “Info” leads to a brief help text explaining the measurement values.

Selecting “Overview” or “esc” exits the Info mode.



Caution

If “--” appears on the display instead of the measurement value, then there may be a defective or incorrect temperature sensor.

If the cables are too long or the sensors are not placed optimally, the result may be small deviations in the measurement values. In this case the display values can be compensated for by making entries on the controller. Follow the instructions under 7.3.

What measurement values are displayed depends on the selected program, the connected sensors and the specific device design.

Statistics

2. Statistics



The menu “2. Statistics” is used for function control and long-term monitoring of the system.

The menu is closed by pressing “esc” or selecting “Exit statistics”.



Caution

For analysis of the system data it is essential for the time to be set accurately on the controller. Please note that the clock does not continue to run if the mains voltage is interrupted, and must therefore be reset. Improper operation or an incorrect time may result in data being deleted, recorded incorrectly or overwritten.

The manufacturer accepts no liability for the recorded data!

2.1 Operating hours

Display of operating hours of the solar pump connected to the controller; various time ranges (day-year) are available.

2.2 Average temperature difference ΔT

Display of the average temperature difference between the reference sensors of the solar system with the consumer switched on.

2.3 Heat output

Display of the heat output of the system.

2.4 Graphic overview

This provides a clearly-organised display of the data listed under 2.1-2.3 as a bar graph. Various time ranges are available for comparison. The two left-hand keys can be used to page through the data.

2.5 Message log

Display of the last 10 events occurring in the system with indication of date and time.

2.6 Reset/clear

Resetting and deleting the individual analyses. The function “All statistics” clears all analyses but not the error messages.

Display mode

3. Display mode

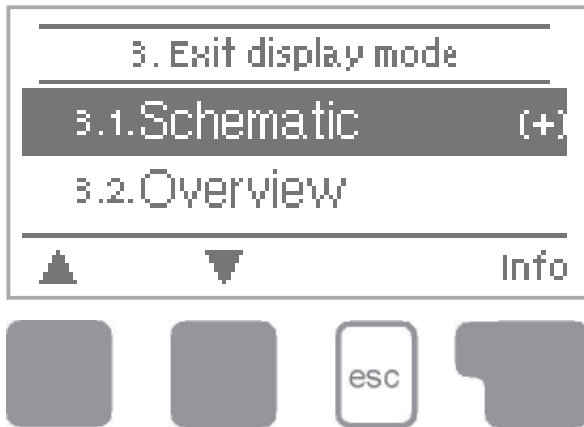

Menu “3. Display mode” is used to define the controller’s display for normal operation.

This display appears whenever two minutes go by without any key being pressed. The main menu appears again when a key is pressed.

The menu is closed by pressing “esc” or selecting “Exit display mode”.

3.1 Schematic

In graphics mode, the selected hydraulic systems are depicted with the measured temperatures and operating states of the connected consumers.

3.2 Overview

In overview mode, the measured temperatures and operating states of the connected consumers are depicted in text form.

3.3 Alternating

In alternating mode the schematic mode and then the overview mode are active for 5 seconds at a time.

Operating modes

4. Operating modes



In menu “4. Operating modes” the controller can either be placed in automatic mode, switched off, or placed in a manual operating mode.

The menu is closed by pressing “esc” or selecting “Exit operating modes”.

4.1 Automatic

Automatic mode is the normal operating mode of the controller. Only automatic mode provides proper controller function taking into account the current temperatures and the parameters that have been set! After an interruption of the mains voltage the controller automatically returns to the last operating mode selected!

4.2 Manual

The relay and thus the connected consumer are switched on and off by pressing a key, with no regard to the current temperatures and the parameters which have been set. The measured temperatures are also shown to provide an overview and function control.



Danger

When operating mode “Manual” is activated, the current temperatures and the selected parameters are no longer considered. There is a danger of scalding or serious damage to the system. The operating mode “Manual” may only be used by specialists for brief function tests or during commissioning!

4.3 Off



Caution

When the operating mode “Off” is activated, all controller functions are switched off. This can lead, for example, to overheating on the solar collector or other system components. The measured temperatures are still displayed to provide an overview.

4.4 Fill system



Caution

This special operating mode is intended only for the filling procedure for a special “Drain Master System” with a fill level contact parallel to collector sensor S1. The instructions on the display must be followed when filling the system. Be sure to terminate the function when finished!

Settings

5. Settings



The necessary basic settings required for the control function are made in menu "5. Settings".



This does not under any circumstances replace the safety facilities to be provided by the customer!

The menu is closed by pressing "esc" or selecting "Exit settings".



Various settings can be made depending on the selection of hydraulic variant 1-20. This is explained in more detail in Table 5.17. This table also indicates the associated reference sensors and switch outputs. The following pages contain generally valid descriptions for the settings.

5.1 Tmin S1

Enable/start temperature at sensor 1

If this value is exceeded at sensor 1 and the other conditions are also met, then the controller switches the associated pump and/or valve on. If the temperature at sensor 1 drops below this value by 5°C, then the pump and/or the valve are switched off again.

Setting range: from 0°C to 99°C/default setting: 20°C

5.2 Tmin S2

Enable/start temperature at sensor 2

If this value is exceeded at sensor 2 and the other conditions are also met, then the controller switches the associated pump and/or valve on. If the temperature at sensor 2 drops below this value by 5°C, then the pump and/or the valve are switched off again.

Setting range: from 0°C to 99°C/default setting: 40°C

5.3 Tmin S3

Enable/start temperature at sensor 3

If this value is exceeded at sensor 3 and the other conditions are also met, then the controller switches the associated pump and/or valve on. If the temperature at sensor 3 drops below this value by 5°C, then the pump and/or the valve are switched off again.

Setting range: from 0°C to 99°C/default setting: 20°C

Settings

5.4 Tmax S2

Switch-off temperature at sensor 2

If this value is exceeded at sensor 2 and the other conditions are also met, then the controller switches the associated pump and/or valve off. If sensor 2 falls below this value again and the other conditions are also met, then the controller switches the pump and/or valve on again.

Setting range: from 0°C to 99°C/default setting: 60°C (30°C in pool variants)



Danger

Temperature values which are set too high can lead to scalding or damage to the system. Scalding protection must be provided by the customer!

5.5 Tmax S3

Switch-off temperature at sensor 3

If this value is exceeded at sensor 3 and the other conditions are also met, then the controller switches the associated pump and/or valve off. If sensor 3 falls below this value again and the other conditions are also met, then the controller switches the pump and/or valve on again.

Setting range: from 0°C to 99°C/default setting: 60°C (30°C in pool variants; in hydraulic variants without S3 default: Off)



Danger

Temperature values which are set too high can lead to scalding or damage to the system. Scalding protection must be provided by the customer!

5.6 ΔT R1

Switch-on/switch-off temperature difference for relay R1

If this temperature difference between the reference sensors is exceeded and the other conditions are also met, then the controller switches the relay R1 on. When the temperature drops to ΔT Off, then R1 is switched off.

Settings range: ΔT from 4°C to 20°C / ΔT Off from 2°C to 19°C

Settings range: ΔT 10°C / ΔT off 3°C.



Caution

If the set temperature difference is too small, this may result in ineffective operation, depending on the system and sensor positions. Special switching conditions apply for speed control (see 7.9)!

Settings

5.7 ΔT R2

Switch-on/Switch-off temperature difference for relay R2

If this temperature difference between the reference sensors is exceeded and the other conditions are also met, then the controller switches the pump and/or the valve on.

When the temperature drops to ΔT Off, then R2 is switched off.

Settings range: ΔT from 4°C to 20°C / ΔT Off from 2°C to 19°C

Settings range: ΔT 10°C / ΔT off 3°C.



Caution

Setting the temperature difference too small may lead to ineffective operation of the system and to frequent switching of the pump, depending on the system and sensor positions.

5.8 Tset S3

Thermostat function at sensor 3

If the temperature at sensor 3 exceeds this value (+hysteresis) the corresponding relay is switched off. If the temperature at sensor 3 falls below this value and the other conditions are also met, the corresponding relay is switched on.

Setting range: from 0°C to 99°C/default setting: 50°C



Danger

Temperature values which are set too high can lead to scalding or damage to the system. Scalding protection must be provided by the customer!



Caution

In Energy saving mode other settings may apply, e.g. TecoS3, see 5.16

5.9 Hysteresis

Hysteresis for thermostat function at sensor 3

By setting the hysteresis value the heating of the storage tank can be adjusted. If the temperature of the Tsetpoint at sensor 3 is exceeded by the set hysteresis, additional heating at relays 2 is deactivated. If the Energy saving mode is active (see 5.16) the system heats up until $T_{minS3} + \text{hysteresis}$ temperature is reached.

Setting range: from 0°C to 20°C/default setting: 10°C

Settings

5.10 Priority sensor

Charging priority in systems with two storage tanks

A setting must be made as to which storage tank (storage tank sensor) has priority for charging. Charging of the lower-priority storage tank is interrupted at regular intervals to check whether the temperature increase at the collector can enable charging of the higher-priority storage tank.

Setting range: S2 or S3/default setting: S2

5.11 T priority

Temperature threshold for absolute priority

In systems with two storage tanks charging of the lower-priority storage tank will never take place until this temperature at sensor of the higher-priority storage tank is exceeded.

Setting range: from 0°C to 90°C/default setting: 40°C

5.12 Loading time

Interruption of charging into the lower priority storage tank

The charging of the lower-priority storage tank is interrupted after the settable time in order to check whether the collector has reached a temperature level that allows charging in the higher-priority storage tank. If so, the priority storage tank is charged. If not, the increase is measured (see 5.13), to check if charging of the priority storage tank will be possible shortly.

Setting range: from 1 to 90 minutes/default setting: 10 minutes

5.13 Increase

Extension of the charging pause due to temperature increase in the collector

For precise setting of the charging priorities for systems with multiple storage tanks, the necessary temperature increase of the collector at which the interruption of the charging into the lower-priority storage tank is extended by one minute is set here. The interruption is extended because the temperature increase of the collector is expected to enable charging in the higher-priority storage tank soon.

As soon as ΔT conditions are met, the priority storage tank is charged. If the rise in temperature falls below the set value, then the charging of the lower-priority storage tank is enabled again.

Setting range: from 1°C to 10°C/default setting: 3°C

5.14 Thermostat periods

Thermostat activity times

Set the desired periods of time when the thermostat should be active. 2 periods can be set per day, settings can also be copied to other days. Outside the set times the thermostat is switched off.

Setting range: from 00:00 to 23:59 /default setting: 06:00 to 22:00

Settings

5.15 „Party Function“

With the party function the storage temperature is heated up once to the reference temperature ($T_{refS3} + \text{hysteresis}$, respectively $T_{ecoS3} + \text{hysteresis}$ in energy saving mode). The party mode is activated by pressing the „esc“-key for 3 seconds in the main menu. While this mode is active, the system heats up to the reference value + hysteresis, unattached to preset thermostat times. The mode is ended once the required temperature is reached.



Caution

Party function is not activated by menu. The ESC key has to be pressed for 3 seconds.



Caution

During Energy saving mode, Party function heats up to $T_{refS3} + \text{hysteresis}$, respectively $T_{ecoS3} + \text{hysteresis}$ in Energy savings mode

5.16 Energy saving mode

Energy saving mode for the thermostat function

In energy saving mode the additional heating via R2 is switched on at T_{ecoS3} and heats up to $T_{eco} + \text{hysteresis}$. When energy saving mode is active, but no solar heat is available, T_{setS3} is used like in normal mode.

Settings range: On, Off/ Default: Off

5.17 TecoS3

Minimum temperature S3 in Energy saving mode

If the temperature at sensor 3 falls below this value and the thermostat function is active (see 5.14 thermostat periods), additional heating via relais R2 is switched on until $T_{minS3} + \text{hysteresis}$ is reached (see 5.9 hysteresis).

Settings range : 0°C to 99°C / Default: 20°C

Protective functions

6. Protective functions



Menu “6. Protective functions” can be used to activate and set various protective functions.



Caution

This does not under any circumstances replace the safety facilities to be provided by the customer!

The menu is closed by pressing “esc” or selecting “Exit settings”.

6.1 Seizing protection

If the seizing protection is activated, then the controller switches the relay in question and the connected consumer on every day at 12:00 and on Sundays at 12:00 for 5 seconds in order to prevent the pump and/or the valve from sticking after an extended stationary period.

Setting range R1: daily, weekly, off/default setting: Off

Setting range R2: daily, weekly, off/default setting: Off

6.2 Frost protection

A two-stage frost protection function can be activated. In stage 1 the controller switches the pump on for 1 minute every hour if the collector temperature drops below the set value “Frost stage 1”.

If the collector temperature drops further to the set value “Frost stage 2” the controller switches the pump on continuously.

If the collector temperature then exceeds the value “Frost stage 2” by 2°C, then the pump switches off again.

Frost protection setting range: on, off/default setting: off

Frost stage 1 setting range: from -25°C to 10°C or off/default setting: 7°C

Frost stage 2 setting range: from -25°C to 8°C/default setting: 5°C



Caution

This function causes energy to be lost via the collector! It is normally not activated for solar systems with antifreeze.

Observe the operating instructions for the other system components!

Protective functions

6.3 System protection

priority protection

System protection prevents overheating of system components by automatic shutdown of the solar pump. If “SProt Ton” is exceeded at the collector, the pump is switched off. The pump is activated again when the temperature drops below “SProt TOff”.

Automatic shutdown - settings range: On / Off / Default: on

SProt Ton - settings range: 60 °C to 150 °C / Default: 120 °C

SProt Toff - settings range: 50 °C to Ton minus 5 °C / Default: 115 °C



When system protection is on, the temperature in the idle collector will be very high, thus the pressure in the system will rise and can damage your system. Pay close attention to the instructions of the system manufacturer.

6.4 Collector protection

Collector protection prevents overheating of the collector. The pump is switched on to transfer heat from the collector to the storage tank.

If “CP Ton” is exceeded at the collector sensor, the pump is switched on until the temperature reaches “CP Toff” or the temperature “CP Tmax storage” is exceeded in the storage or pool.

Collector protection settings range: on / off / Voreinstellung: off

CP Ton settings range: 60°C to 150°C / Default: 110°C

CP Toff settings range: 50°C to Ton minus 5°C / Default: 100°C

CP Tmax storagesettings range: 0°C to 140°C / Default: 90°C



When collector protection is active, the storage or pool is heated well beyond Tmax S2 (see 5.2) which can result in scalding and system damage.

Protective functions

6.4.1 Cooling functions

The hydraulic variants are set in menu „7.1 Program selection“

Hydraulic Variant D.14 Solar + cooling 1:

If „CProt Ton“ is exceeded at S1, the cooler at R2 is switched on till the temperature drops to „CProt Toff“. If the storage tank exceeds „CProt Tmax storage“, the system is switched off.

Hydraulic Variant D.15 Solar + cooling 2:

If „CProt Ton“ is exceeded at S1, the cooler at R2 is switched on. If the storage tank exceeds „CProt Tmax storage“, R1 is switched off with R2 still running to keep on cooling. If the temperature at S1 drops to „CProt Toff“, cooling is switched off.

Hydraulic Variant D.16 Solar + cooling 3:

If „CProt Ton“ is exceeded at S1, the pump at R1 is switched on to cool the collector by heating up the storage tank.

If the storage tank S2 reaches „CProt Tmax storage“, R1 is switched off.

Once the storage tank at S3 exceeds TsetS3, cooling at R2 is switched on till „TsetS3“-hysteresis is reached.

6.5 Col.- Alarm

If this temperature is exceeded at the collector sensor when the solar pump is on a warning or error message is triggered. A warning message is shown in the display.

Collector alarm settings range: on / off / Default: off

Col. alarm - setting range: 60 °C to 300 °C / Default: 150 °C

6.6 Recooling

In hydraulic systems with solar when the recooling function is activated excess energy from the storage tank is fed back into the collector. This only takes place if the temperature in the storage tank is higher than the value “Recool Tsetpoint” and the collector is at least 20°C cooler than the storage tank and before the storage tank temperature has dropped below the value “Recool Tsetpoint”. In systems with two storage tanks the setting applies to both storage tanks.

Recooling setting range: on, off/default setting: off

Recooling Tsetpoint setting range: from 0°C to 99°C/default setting: 70°C



Caution

This function causes energy to be lost via the collector! Recooling should only be exceptionally.

Protective functions

6.7 Anti-Legionella

With the “AL function” activated the TDC 3 makes it possible to heat the storage tank to a higher temperature (“AL Tsetpoint S2”, provided that the energy source allows this. Time periods when the AL heat up is attempted are to be setup in the menu “AL times” Once the temperature “AL Tset S2” is reached, the controller will try to maintain this temperature for the time period set in “AL residence time”. When this is successful, the time and date is saved and displayed in the menulog “AL heat”.

AL Function settings range: on / off / Default: off

AL Tset S2 settings range: 60°C to 99°C / Default: 70°C

AL residence time - settings range: 1 to 60 minutes / Default: 15 minutes

AL heat. (no setting): Displays the date and time of the last successful AL heat up

AL times - settings range: Mo-Su , 0-24h/ Default: daily 3-5h



Caution

The anti-Legionella function is switched off at delivery.

This function is only relevant for storage tanks where sensor 2 is installed. Whenever heating-up has been carried out with the anti-Legionella function being switched on, an information message with the date is shown in the display.



Danger

During the anti-Legionella function the storage tank is heated up over the set value “Tmax S2”, which can lead to scalding and damage to the system.



Caution

This anti-Legionella function does not provide complete protection against Legionella, because the controller is dependent on sufficient energy being fed in, and it is not possible to monitor the temperatures in the entire range of the storage tanks and the connected piping system. To provide complete protection against Legionella bacteria, it must be ensured that the temperature is raised to the necessary temperature, and at the same time there must be water circulation in the storage tank and piping system by means of other additional energy sources and control units.

Special functions

7. Special functions



Menu “7. Special functions” is used to set basic items and expanded functions.



Caution

Other than the time all settings may only be made by a specialist.

The menu is closed by pressing “esc” or selecting “Exit special functions”.

7.1 Program selections

The suitable hydraulic variant for the specific application is selected and set here (see B.5 Hydraulic variants). The associated diagram can be displayed by pressing “info”.

Setting range: 1-15/default setting: 1



Caution

Normally the program selection is made only once during initial commissioning by the specialist. Incorrect program selection can lead to unpredictable errors.

7.2 Time & date

This menu is used to set the current time and date.



Caution

For analysis of the system data it is essential for the time to be set accurately on the controller. Please note that the clock does not continue to run if the mains voltage is interrupted, and must therefore be reset.

7.3 Sensor calibration

Deviations in the temperature values displayed, for example due to cables which are too long or sensors which are not positioned optimally, can be compensated for manually here. The settings can be made for each individual sensor in steps of 0.5°C.

Offset S1...S3 per setting range: -100 to +100 (translates to -50°C...+50°C)

Default setting: 0



Caution

Settings are only necessary in special cases at the time of initial commissioning by the specialist. Incorrect measurement values can lead to unpredictable errors.

Special functions

7.4 Commissioning

Starting the commissioning help guides you in the correct order through the basic settings necessary for commissioning, and provides brief descriptions of each parameter in the display.

Pressing the “esc” key takes you back to the previous value so you can look at the selected setting again or adjust it if desired. Pressing the “esc” more than once takes you back to the selection mode, thus cancelling the commissioning help. (see also E.2).



Caution

May only be started by a specialist during commissioning! Observe the explanations for the the individual parameters in these instructions, and check whether further settings are necessary for your application.

7.5 Factory settings

All of the settings that have been made can be reset, thus returning the controller to its delivery state.



Caution

The entire parametrisation, analyses, etc. of the controller will be lost irrevocably. The controller must then be commissioned once again.

7.6 Expansions

This menu can only be selected and used if additional options or expansions have been built into the controller.

The associated supplementary installation, mounting and operation instructions are then included with the specific expansion.

7.7 Heat quantity

A simple heat metering function for basic system control can be activated in this menu. Additional settings regarding the glycol, the percentage of glycol and the flow rate of the system are required.



Caution

Resulting data is only approximate value for function control!

Special functions

7.7.1 Heat metering

Activate or deactivate the heat metering function

Settings range: On/off /default setting: Off

7.7.2 AF type

Adjust the type of glycol that has been used in the system.

Settings range: Ethylene/Propylene /default setting: Ethylene

7.7.3 Glycol portion

Adjust the percentage of glycol that has been used in the system.

Settings range: 0-60% /default setting: 40%

7.7.4 Flow rate

Adjust the flow rate according to the system.

Settings range: 10-5000 l/h /default setting: 500 l/h

7.7.5 ΔT Offset

Since the calculation of the heat metering is based on the temperature of the collector and storage where measuring takes place, a possible deviation from the flow and return temperature can be compensated with this value.

Example: Displayed collector temp. 40° C, measured flow temp. 39° C, displayed storage temp. 30° C, measured return temp. 31° C means a setting of -20% (Displayed ΔT 10K, actual ΔT 8K => -20% correction value)

Settings range: -50% to +50% /default settings: 0%

7.8 Start aid function

With some solar systems, especially with vacuum tube collectors, it may occur that the measurement value acquisition at the collector sensor occurs too slowly or too inaccurately because the sensor is often not at the hottest location. When the start help is activated the following sequence is carried out:

If the temperature at the collector sensor increases by the value specified under "Increase" within one minute, then the solar pump is switched on for the set "Purging time" so that the medium to be measured can be moved to the collector sensor. If this still does not result in a normal switch-on condition, then the start help function is subject to a 5-minute lockout time.

Start help setting range: on, off/default setting: off

Purging time setting range: 2 ... 30 sec./default setting: 5 sec.

Increase setting range: 1°C...10°C/default setting: 3°C/min.



Caution

This function should only be activated by a specialist if problems arise with acquisition of measurement values. In particular follow the instructions from the collector manufacturer.

Special functions

7.9 Speed control

If the speed control is activated, the TDC3 makes it possible to vary the speed of standard pumps at relay R1 by means of special internal electronics.



This function should only be activated by a specialist. Depending on the pump and pump stage used, the minimum speed should not be set too low, because otherwise the pump or the system may be damaged. The information provided by the relevant manufacturer must also be observed! If in doubt, the min. speed and the pump stage should generally be set to high rather than too low.

7.9.1 Variant

The following speed variants are available here:

Off: There is no speed control. The connected pump is only switched on or off with full speed.

Variant V1: After the purging time the controller switches to the set max. speed. If the temperature difference ΔT between the reference sensors (collector and storage tank) is less than the set value, then the speed is decreased by one stage after the control time elapses. If the temperature difference between the reference sensors is greater than the set value, then the speed is increased by one stage after the control time elapses. If the controller has adjusted the speed of the pump down to the smallest stage and the ΔT between the reference sensors is ΔT off, the pump is switched off.

Variant V2: After the purging time the controller switches to the set min. speed. If the temperature difference ΔT between the reference sensors (collector and storage tank) is greater than the set value, then the speed is increased by one stage after the control time elapses. If the temperature difference ΔT between the reference sensors is below the set value, then the speed is decreased by one stage after the control time elapses. If the controller has adjusted the speed of the pump down to the smallest stage and the ΔT between the reference sensors is $T\Delta$ off, the pump is switched off.

Variant V3: After the purging time the controller switches to the set min. speed. If the temperature at the reference sensor (collector) is greater than the setpoint to be set subsequently, then the speed is increased by one stage after the control time expires. If the temperature at the reference sensor (collector) is less than the setpoint to be set subsequently, then the speed is decreased by one stage after the control time expires.

Setting range: V1,V2,V3, off/default setting: off

Variant V4: (2 storages)

When the valve is set toward the primary storage, speed control works as in V3.

When the valve is set toward the secondary storage, speed control works as in V2.

Settings range: V1,V2,V3, Off / Default: Off

Speed control settings continued on page 42

Special functions

7.9.2 Purging time

During this time the pump starts up at its full speed (100%) to ensure reliable starting. Only after this purging time does the pump run with speed control and switches to the max. or min. speed, depending on the variant set.

Setting range: from 5 to 600 seconds/default setting: 8 seconds

7.9.3 Sweep time

The control time is used to determine the delay for speed control in order to avoid large temperature oscillations as much as possible. The time span required for a complete control process from minimum speed to maximum speed is entered here.

Setting range: from 1 to 15 minutes/default setting: 4 minutes

7.9.4 Max. speed

The maximum speed of the pump at relay R1 is specified here. During the setting the pump runs at the specified speed and the flow rate can be determined.

Setting range: from 70 to 100%/default setting: 100%



Caution

The indicated percentages are guide values that may vary to a greater or lesser extent depending on the system, pump and pump stage.

7.9.5 Min. speed

The minimum speed of the pump at relay R1 is specified here. During the setting the pump runs at the specified speed and the flow rate can be determined.

Setting range: from 30 to max. speed -5%/default setting: 50%



Caution

The indicated percentages are guide values that may vary to a greater or lesser extent depending on the system, pump and pump stage.

7.9.6 Setpoint

This value is the control setpoint for variant 3. If the value at the collector sensor drops below this, the speed is reduced. If it rises above this, the speed is increased.

Setting range: from 0 to 90°C/default setting: 60°C

Menu lock

8. Menu lock



Menu “8. Menu lock” can be used to secure the controller against unintentional changing of the set values.

The menu is closed by pressing “esc” or selecting “Exit menu lock”.

The menus listed below remain completely accessible despite the menu lock being activated, and can be used to make adjustments if necessary:

1. Measurement values
2. Analysis
3. Display mode
- 7.2. Time&date
8. Menu lock
9. Service values

To lock the other menus, select “Menu lock on”.

To enable the menus again, select “Menu lock off”.

Setting range: on, off/default setting: off

Language

10. Language



Menu “10. Language” can be used to select the language for the menu guidance. This is queried automatically during initial commissioning.

The choice of languages may differ, however, depending on the device design. Language selection is not available in every device design!

Service values

9. Service values

```

9.1TDC3-ML 2010/04/14.6825
9.2.Collector      50°C
9.3.Storage       42°C
  
```



The menu “9. Service values” can be used for remote diagnosis by a specialist or the manufacturer in the event of an error, etc.



Caution

Enter the values at the time when the error occurs e.g. in the table.

The menu can be closed at any time by pressing “esc”.

9.1.	
9.2.	
9.3.	
9.4.	
9.5.	
9.6.	
9.7.	
9.8.	
9.9.	
9.10.	
9.11.	
9.12.	
9.13.	
9.14.	
9.15.	
9.16.	
9.17.	
9.18.	
9.19.	
9.20.	
9.21.	
9.22.	
9.23.	
9.24.	
9.25.	
9.26.	
9.27.	
9.28.	
9.29.	
9.30.	

9.31.	
9.32.	
9.33.	
9.34.	
9.35.	
9.36.	
9.37.	
9.38.	
9.39.	
9.40.	
9.41.	
9.42.	
9.43.	
9.44.	
9.45.	
9.46.	
9.47.	
9.48.	
9.49.	
9.50.	
9.51.	
9.52.	
9.53.	
9.54.	
9.55.	
9.56.	
9.57.	
9.58.	
9.59.	
9.60.	

Malfunctions

Z.1. Malfunctions with error messages

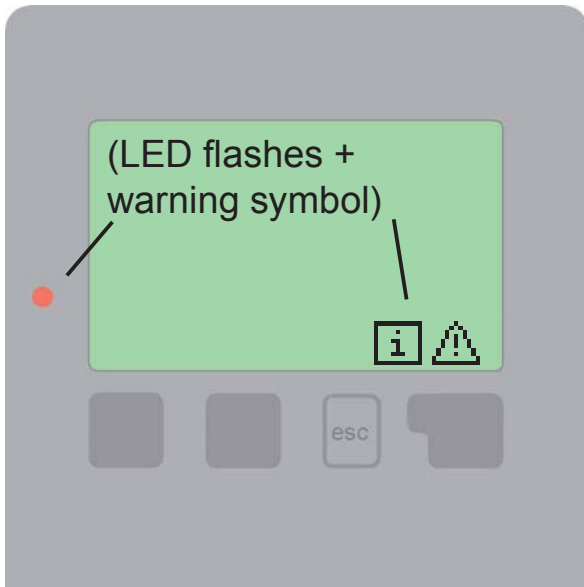

If the controller detects a malfunction, the red light flashes and the warning symbol also appears in the display. If the error is no longer present, the warning symbol changes to an info symbol and the red light no longer flashes.

To obtain more detailed information on the error, press the key under the warning or info symbol.



Do not try to deal with this yourself.
Consult a specialist in the event of an error!

Possible error messages:

Sensor x defective ----->

Notes for the specialist:

Means that either the sensor, the sensor input at the controller or the connecting cable is/was defective.
(Resistance table see B.1)

Collector alarm ----->

Means that the collector has fallen/fell below the temperature set under menu 6.5

Night circulation ----->

Means that the solar pump is/was in operation between 23:00 and 04:00. (Exception see 6.6)

Restart ----->

Means that the controller was restarted, for example due to a power failure. Check the date&time!

Time&date ----->

This message appears automatically after a mains failure because the time&date have to be checked, and reset if necessary.

Malfunctions

Z.2 Replacing the fuse



Repairs and maintenance may only be performed by a specialist. Before working on the unit, switch off the power supply and secure it against being switched on again! Check for the absence of power!



Only use the supplied spare fuse or a fuse of the same design with the following specifications: T2A 250V

Z.2.1

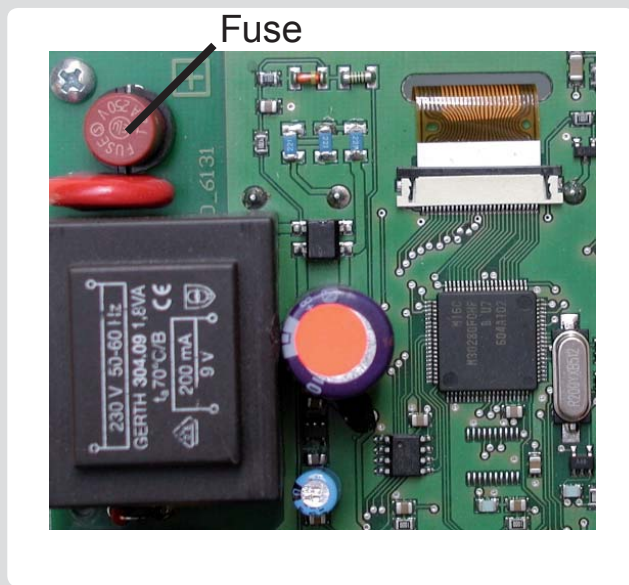

If the mains voltage is switched on and the controller still does not function or display anything, then the internal device fuse may be defective. In that case, open the device as described under C, remove the old fuse and check it.

Exchange the defective fuse for a new one, locate the external source of the error (e.g. pump) and exchange it.

Then first recommission the controller and check the function of the switch outputs in manual mode as described under 4.2.

Z.3 Maintenance



In the course of the general annual maintenance of your heating system you should also have the functions of the controller checked by a specialist and have the settings optimised if necessary.

Performing maintenance:

- Check the date and time (see 7.2)
- Assess/check plausibility of analyses (see 2.4)
- Check the error memory (see 2.5)
- Verify/check plausibility of the current measurement values (see 1.)
- Check the switch outputs/consumers in manual mode (see 4.2)
- Poss. optimise the parameter settings

Hydraulic variant set:

Commissioned on:

Commissioned by:

Instead of setting the flow rate for the system using a flow rate limiter, it is better to adjust the flow rate using the switch on the pump and by means of the “max. speed” setting on the controller (see 7.9.4). This saves electricity!

The service values (see 9.) include not only current measurement values and operating states, but also all of the settings for the controller. Write the service values down just once after commissioning has been successfully completed.

In the event of uncertainty as to the control response or malfunctions the service values are a proven and successful method for remote diagnosis. Write the service values down (see 9.) at the time that the suspected malfunction occurs. Send the service value table by fax or e-mail with a brief description of the error to the specialist or manufacturer.

In program 1 “Solar with storage tank” the mechanical relay R2 switches together with the speed-controlled output R1. Relay output R2 can be used to operate larger loads up to 460VA, as well as valves or auxiliary relays with low power.

In program 13 “Solar with storage tank and pool” the charging of the pool, e.g. for winter operation, can be switched off using a simple function. To do this, simply press and hold the “esc” key down for several seconds on the diagram/overview screen. A message appears on the display as soon as the pool is switched off or when the pool is switched on again.

Programs 20 + 21 “Universal ΔT controller” are suitable, for example, for hydraulic variants with solid-fired boiler, follow-on storage tank charging, storage tank transfer, heating circuit return lift, etc.

The Operating hours displayed in the “Analysis” menu are solar operating hours. This therefore only takes into account hours in which the solar pump is active. In the universal programs 20 + 21 the times refer to relay R1.

To protect against loss of data, record any analyses and data that are particularly important to you (see 2.) at regular intervals.

Final declaration:

Although these instructions have been created with the greatest possible care, the possibility of incorrect or incomplete information cannot be excluded. Subject as a basic principle to errors and technical changes.

Manufacturer:

SOREL GmbH Mikroelektronik

Jahnstr. 36

D - 45549 Sprockhövel

Tel. +49 (0)2339 6024

Fax +49 (0)2339 6025

www.sorel.de info@sorel.de

Your specialist dealer: