

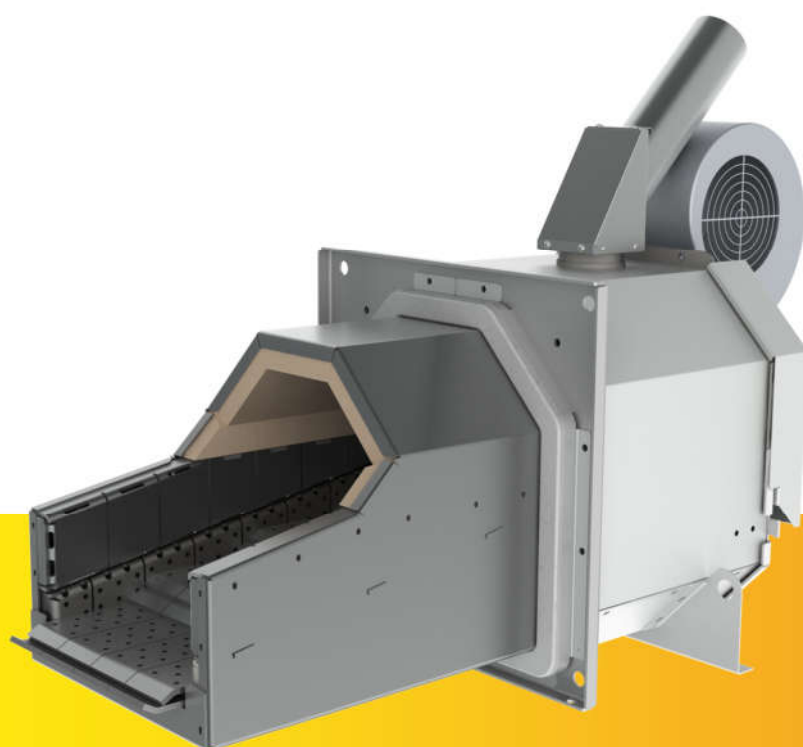

**ECO-PALNIK**

*Skiepko*



Operation and Maintenance manual for pellet

Eco-Burner (Eco-Palnik)

Line UNI-MAX O 100-1000kW

# Table of Contents

Table of Contents.....	2
1. GENERAL INFORMATION.....	3
1.1 Comments regarding transport.....	3
1.2 Place around the burner.....	3
2. Description of the Burner.....	4
2.1 Required parameters of pellet fuel.....	4
2.2 Technical parameters of UMO burners:.....	5
2.3 Composition of set.....	7
2.4 Burner in the boiler house.....	8
3. Burner design and operation.....	9
4. Eco-Burner Installation.....	11
4.1 Principles for selection of pellet burners for district heating boilers.....	11
4.2 Installation manual for UNI-MAX O:.....	12
5. Operation.....	13
5.1 Display symbols.....	14
6. Start-Up.....	15
6.1 Execution of the controller function.....	16
6.2 Diagram of controller connection to ECO-BURNER.....	19
7. Preliminary settings of the manufacturer – basic parameters of the burner.....	25
8. Elements of pellet burner protections.....	27
9. Recommendations.....	28
10. Conditions of proper and safe operation.....	29
11. Cleaning and maintenance.....	30
11.1 Grate cleaning.....	30
11.2 Igniter replacement.....	31
11.3 PHOTOCCELL CLEANING.....	33
12. Removal of burner after expiry of its service life.....	35
13. DEFECTS.....	35
14. SPECIMEN OF THE TYPE PLATE.....	38
DECLARATION OF CONFORMITY EC 04/P/16.....	39
TERMS AND CONDITIONS OF THE GUARANTEE.....	40
15. INSTALLATION REPORT.....	41
16. Composition of the set.....	42

10.2019

# 1. GENERAL INFORMATION

**Before starting the burner, the manual should be read carefully.**

Application of the principles presented in the manual is the basis for correct and safe installation and operation of the device.

The user of boiler heating equipment is obligated to read and comply with the local legal regulations related to installation and operation of the boiler house. The user is responsible for handover of the boiler house for operation in accordance with all the requirements of the construction law.

Improper installation may result in invalidity of the manufacturer's guarantee. The manufacturer is not responsible for installation non-compliant with the construction law standards, local regulations and guidelines, as well as for lack of relevant permits and certificates.

## 1.1 Comments regarding transport

The pellet burner and accessories are fragile, therefore they have been thoroughly protected for the transport. Special attention should be paid to packaging during transport:

- 1) The packaging should be protected against adverse weather conditions (large sun exposure, rain, snow and dust).
- 2) The packaging should be protected against rapid movements during loading, unloading and transport (throwing, rapid displacement, crushing with objects with greater mass, etc.),

In the case of delivery of the shipment by forwarding companies, check the content in the presence of the courier. In the case the burner is damaged, carry out a test to verify the components. In the event of damage, prepare a report. If damage is found, contact the manufacturer.

## 1.2 Place around the burner

A free space should be provided around the boiler of minimum 100 cm in order to enable installation and later access for cleaning and maintenance of the device. The boiler house should meet the requirements of construction law and should be clean, dry and well ventilated. Flammable materials (including bags with pellets) should not be stored at a distance smaller than 50 cm from the device

## 2. Description of the Burner

Eco-burner type device is an automatic burner combusting pellet (granulate made of sawdust and wood chips). It is intended for cooperation with district heating boilers combusting solid fuels. It may be also used in certain gas and oil boilers after their adaptation to combustion of solid fuels (e.g. after the use of the combustion chamber allowing for collection and removal of ash) and in technological processes.

In the equipment, unique solutions have been used:

- stepless burner power modulation. The more it approximates the boiler preset temperature, the less granulate it takes.
- the burner is equipped with mobile step-type grate,
- easy grate revision system - a unit of mobile grate in the form of a withdrawable drawer. total and complete combustion system - almost zero CO emission

The burner is an "environmentally friendly" device and is characterized by low flue gas emission and low electricity consumption. The structure of the burner provides for original solutions of stepless burner power modulation, which assumes that the more the temperature of the heating medium in the boiler approximates the temperature preset at the boiler controller, the more the fuel consumption is reduced-adjusted to the current demand. The burner cooperates with the room thermostat maintaining the preset temperature value in the room. Thus, operation of the burner is limited only to making up the fuel in the bunker and periodical ash removal. Structure of the burner causes that there is no danger of boiler overheating in the case of electric power supply failure, because the portion of fuel combusted on the grate is small. In the case of electric power supply failure, the burner is automatically deactivated and activated. The burner is prepared for combustion of fuel with the physical and chemical properties specified below.

### 2.1 Required parameters of pellet fuel

<b>Diameter Ø</b>	6-8 mm
<b>Length</b>	4-40 mm
<b>Density</b>	≥ 600 kg
<b>Fine fraction content below</b>	3mm 0,8%
<b>Net calorific value</b>	≥15 MJ/kg lub ≥4,4 kWh/kg
<b>Ash content</b>	≤ 2,0%
<b>Moisture content</b>	≤ 10%
<b>Ash melting temperature</b>	Nie określa się

Burner power is specified for the use of pellet manufactured according to DIN or DIN PLUS specification. For the fuel with other physical and chemical properties, the device parameters may change

#### **Warning!!!**

The burner cannot burn fuel with HDF or MDF board waste as well as straw and hay pellets

Using such fuel may void your warranty.



## 2.2 Technical parameters of UMO burners:

Lp.	Size [kW]	100	150	200	250	300	400	500	750	1000	
1	<b>Max/Min power [kW]</b>	100/20	150/30	200/30	250/50	300/50	400/100	500/100	750/150	1000/200	
2	<b>FD fan power[W]</b>	WPA 145 160W	WPA 145 160W	DM16 SF 260W	DM16 SF 260W	2x DM16 SF 2x260 W	2x DM16 SF 2x260W	2x DM16 SF 2x260 W	2x DM16 SF 2x WPA06	3x DM16 SF 2x DM15 SF	
3	<b>Voltage</b>	~230V									
4	<b>Igniter power</b>	300 W				2x 300 W					
5	<b>Fuse</b>	8A									
6	<b>Required stack draft</b>	5-15 Pa									
7	<b>Negative pressure on the combustion chamber</b>	It is required that negative pressure in the combustion chamber allows for collection of 100% of flue gas for the maximum power of the burner.									

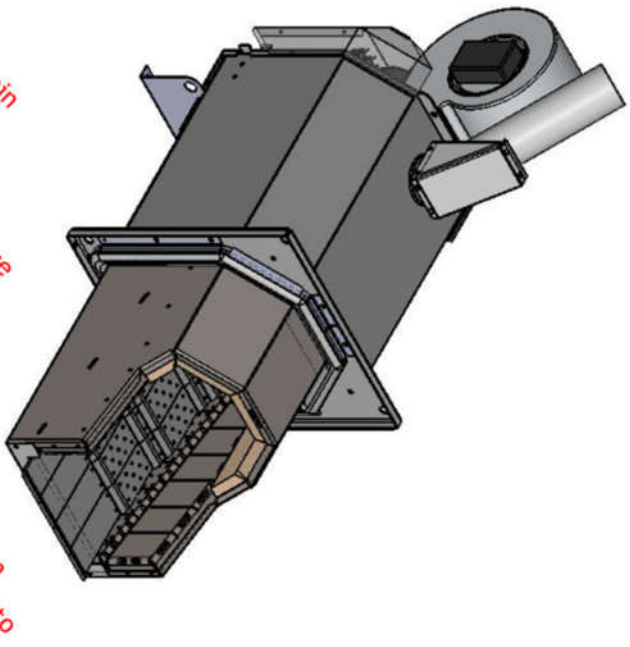
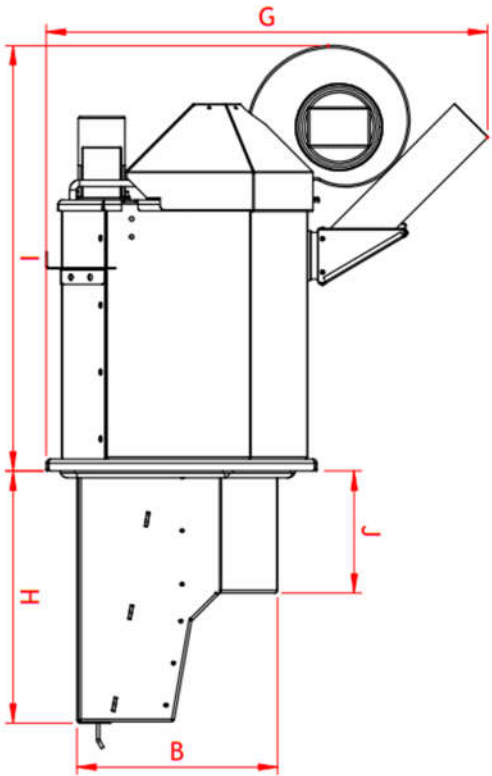
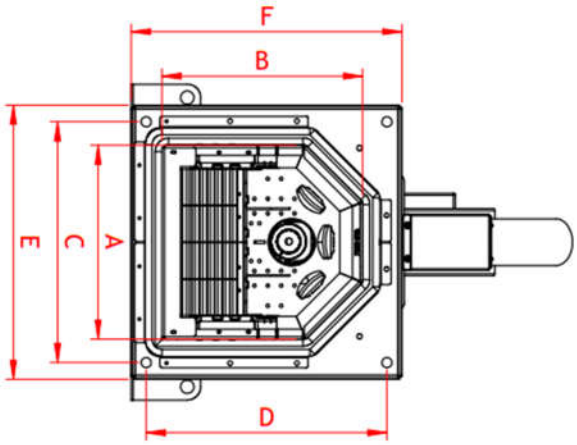

Power (kW)	A	B	C	D	E	F	G	H	I	J
100	236	270	320	280	350	350	612.5	377	391	182.5
150	236	270	320	280	350	350	612.5	377	505	182.5
200	290	300	360	360	410	405	660	377	522	182.5
250	290	300	360	360	410	405	660	377	636	182.5
300	350	360	470	400	520	490	793	420	567	190
400	400	430	540	520	600	602.5	900	420	637.5	190
500	530	470	600	530	640	580	830	425	737.5	190
750	575	480	650	545	705	600	905	575.5	786.5	235
1000	662.5	800	730	890	800	950	1115	617.5	1165	275

\*distance with standard strain relief  
Dimensional tolerance  $\pm 5\text{mm}$

## 2.3 Composition of set

The set includes – check completeness of the set:

• fan burner	
• Ø70 strain relief	
• Controller including boiler temperature sensors, protecting sensor and domestic hot water sensor.	
• feeder	
• spiro pipe	
• power supply cable,	
• cable connecting the control with the feeder	



### **Uwaga!**

The manufacturer has the exclusive right to make structural changes of the burner, feeder and control, including its software and cabling. Any changes made without consultation and authorization of the manufacturer result in invalidity of the guarantee and release the manufacturer from any liability

## 2.4 Burner in the boiler house

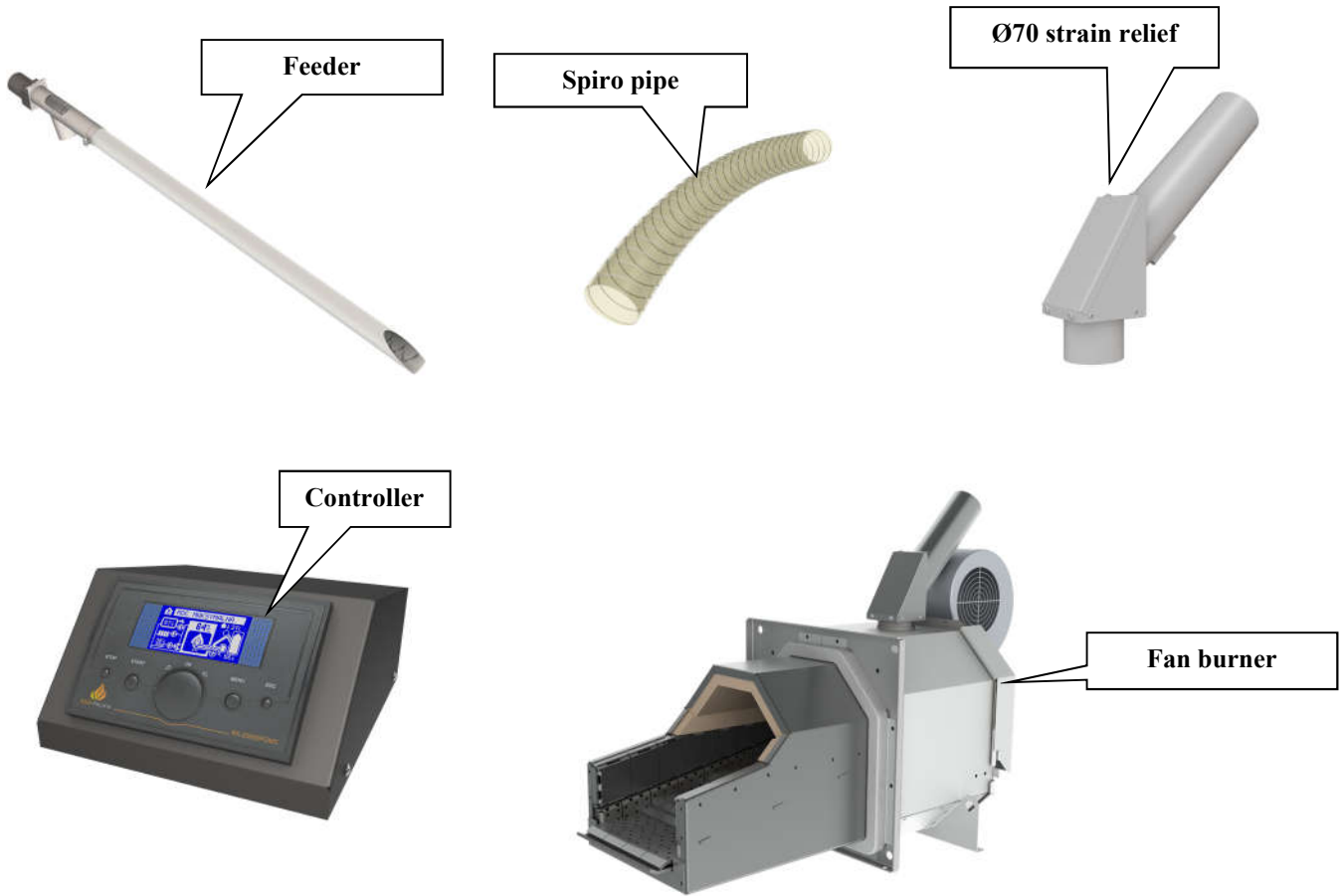



### 3. Burner design and operation

Eco-burner is of modular design, bolted and assembled of individual elements: the furnace, together with the ceramic lining, main fixing slab, mobile grate: step and segment type, together with the drive system installed on the drawer - removed backwards - air chamber integrated with the burner fixing slab, fuel feeding system, FD fan and built-in igniter. The entire burner is enclosed with a three-part casing with a controller located in a separate casing to be installed on the boiler, wall or bunker.

The materials used for the structure are of the highest quality: heat resistant, acid resistant and stainless steel. The furnace is polygonally shaped. After installation, the most part of the furnace is placed in the boiler and the external surface of the burner during operation does not heat up, since it is cooled with air.

Operation of the burner is fully automatic, all phases of the combustion process - firing, burning, standby and flameout are programmed automatically.

The firing process begins with activation of the fan to purge the boiler combustion chamber and remove the accumulated gases. Then the igniter is activated. The pellet is fired in the hot air stream heated up to 820 degrees Celsius. The basic method of flame detection is based on a photoelement commonly referred to as the photocell, which analyzes presence of the flame in the combustion chamber on an on-going basis. For this purpose it is also possible to use the flue gas temperature sensor type PT-1000 in the boiler flue or the burner temperature sensor. The controller handles all three flame detection methods.

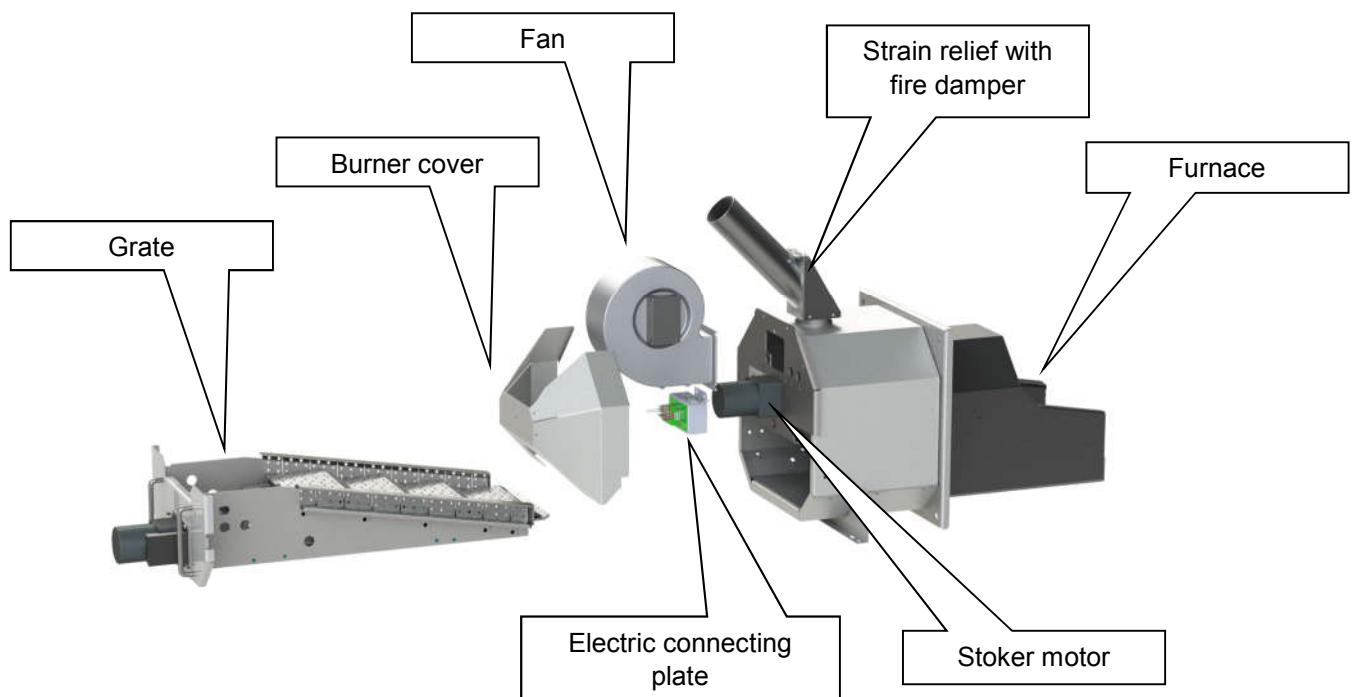

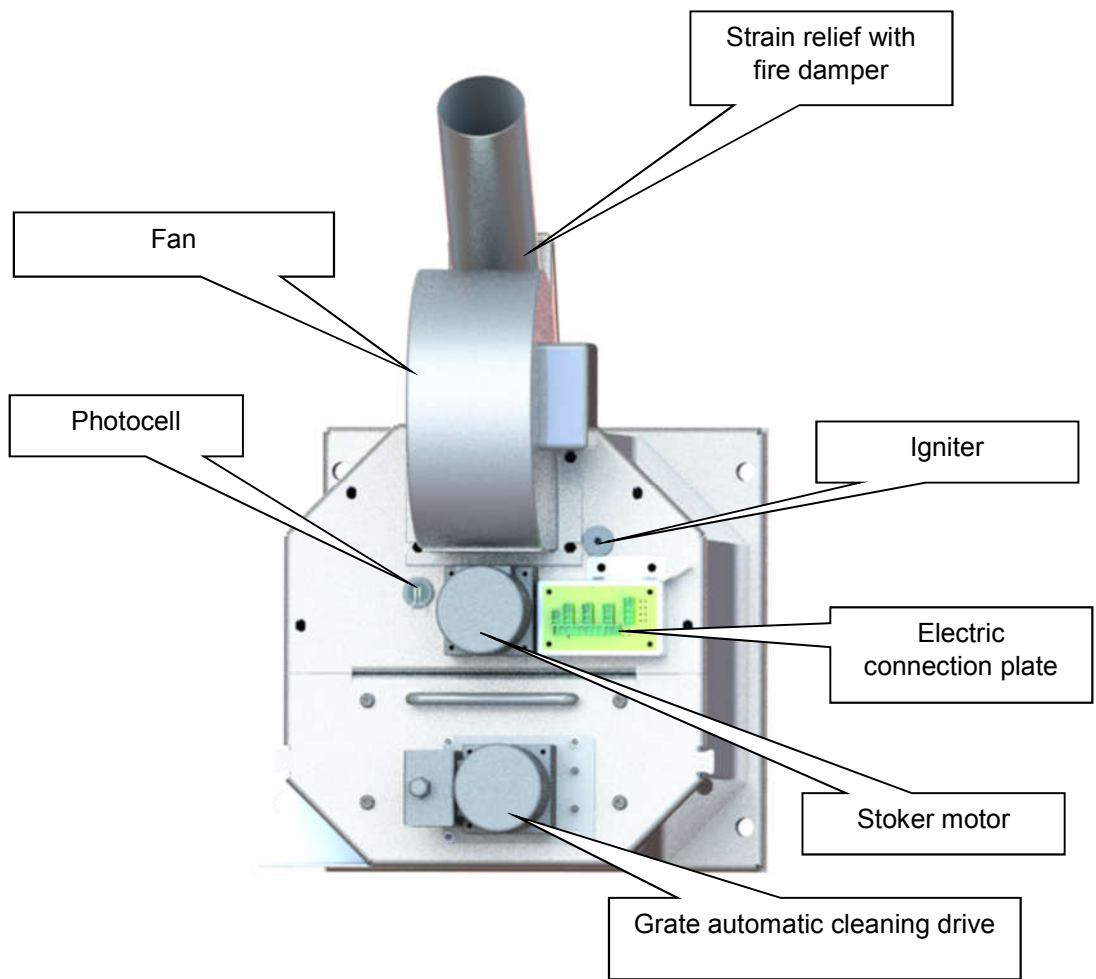
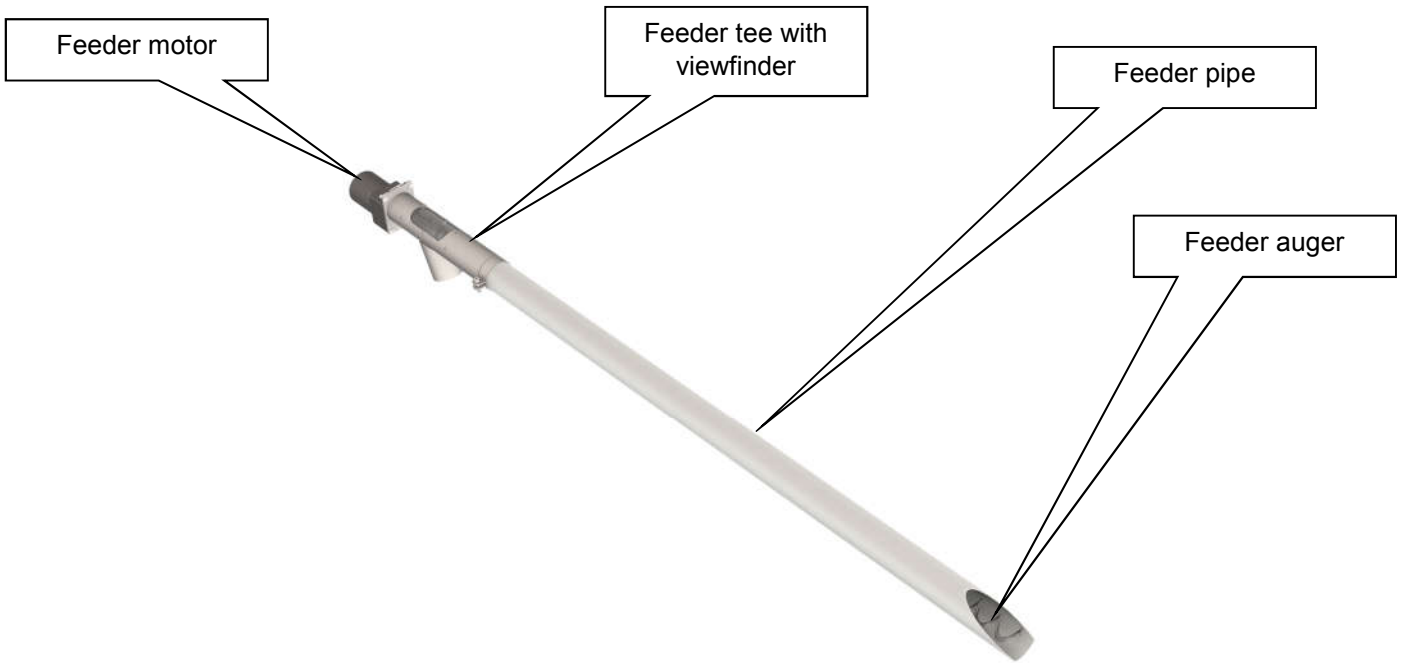

## 4. Eco-Burner Installation

Eco-burner is intended for installation in the district heating boilers. It is recommended to place the burner in the boiler door or at the boilers with the eco-pea coal feeder in the place of the retort. Depending on the boiler structure, such installation method should be selected so as to ensure the highest efficiency of the entire system and allow ash removal and easy revision and maintenance of the burner.

If the door is too narrow, we suggest asymmetrical installation - closer to the hinges so that the furnace does not interfere with the boiler door frame and the door opens together with the burner without its disassembly.

Installation and start-up should be carried out by an authorized service technician trained by the Manufacturer. Eco-burner should be installed according to the below manual.



**Note!** Prior to commencement of installation or disassembly, disconnect power supply of the burner and the boiler



**Note!** Prior to commencement of installation and then operation of the burner, clean the stack and boiler thoroughly and check whether there is sufficient amount of fluid in the system and if the overflow vessel (if any) operates properly.

### 4.1 Principles for selection of pellet burners for district heating boilers

When selecting the pellet burner for the oil, gas or fuel boiler, numerous aspects should be taken into account. The most important criteria are listed below:

#### 1. Burner and its power - principles for selection

- Due to the fact that during pellet combustion more gas is produced than in the case of fuel oil or gas, to achieve the same power of the device burners with power higher than the rated power of the boiler are not installed.
- Oil burners can operate at overpressure in the combustion chamber, whereas the pellet burners should generally operate at negative pressure in the combustion chamber. Slight overpressure in the combustion chamber of the boiler is acceptable if the burner is equipped, on the fuel feeding line, with a cell lock or automatic fire damper operating independently of electricity. The damper releases fuel toward the burner and blocks the gas flow in the opposite direction, i.e. toward the feeder.
- The main criterion for selection of the burner horsepower for oil boilers covers not the boiler horsepower, but the heat demand of the facility. In most cases, the boiler horsepower is much redesigned in relation to the heat demand, even in the case of very low above zero temperatures. Thus, the selection is based on fuel consumed in a unit of time, e.g. during the heating season.

#### 2. Boiler structure:

- Design of the boiler is the most important criterion to state whether a given boiler is suitable to insert the pellet burner. Pellet burners can be only inserted in boilers with a closed combustion chamber and allowing for collection of solid combustion products, i.e. slag and ash and for cleaning of the heat exchanger.
- Flue gas route, the fact whether the boiler is three- or two-line, whether flue gas is evacuated from the burner or whether the boiler is equipped with flue gas return water box are important as well.

- The design and the size of the combustion chamber /flue/, its diameter and depth, the distance between the burner and the opposite walls is important in relation to the length of the flame of the burner for the rated power. The length of the combustion chamber should be greater than the length of the combustion chamber. If the length of the combustion chamber is not sufficient, a deflector or the flue head insulator should be provided.
- Design of the heat exchanger. Design of the heat exchanger is important, in particular the susceptibility to pollution - arrangement and structure of the active elements collecting heat from flue gas in relation to the burner outlet and susceptibility to pollution, also to backfilling with fly ash.
- Type, amount, structure of vortex generators /swirl inserts/ and their impact on the flue gas flow resistance and susceptibility to pollution.

3. Stack draft. The stack draft should evacuate the flue gas stream in all modes of the burner operation, firing phase, burning with maximum power /mostly rated/, minimum power and during the furnace flameout.

Size of the stack draft depends on:

- stack cross-section
- stack height
- local conditions, caused by enclosing with trees or buildings
- difference of flue gas temperature at the inlet and outlet

weather conditions.

## 4.2 Installation manual for UNI-MAX O:

1. Install the burner in the boiler door after prior provision of installation openings. Open the burner cover and connect the control cable to the appropriate socket on the fixing slab. Fix the cable to the casing using the attached gland.
2. Place the bunker next to the boiler, insert the feeder in the bunker opening and suspend the feeder.
3. Place the strain relief on the burner and connect the feeder outlet using "spiro" pipe with an appropriate length in order to maintain the fuel slope line not lower than 45 degrees.
4. Install the box together with the controller in the selected place (at the bunker, on the wall, the boiler) in such a way that it is not exposed to direct temperature impact.
5. Connect the district heating and domestic hot water pumps by means of conductors. Connect the feeder with the controller using the attached cable.
6. Distribute the sensors appropriately:
  - Boiler sensor - in the capillary on the boiler intended for the sensors or for the boiler shell underneath the insulation - preferably in the vicinity of the power supply nozzle or directly on the feed pipe as close as possible to the boiler /upstream the pump/ ensuring good contact and insulation for correct indications.
  - Feeder sensor - in the holder on the strain relief.
7. Connect the power supply cable of the feeder and the power supply to the sockets in the control box. Ensure that the so-called PHASE is located on the power supply plug in the place marked with "L".
8. Fill the bunker with fuel.
9. Activate the power supply using the main switch.
10. Fill the feeder with pellet - press the START button until the message FILLING is displayed. After effective transfer of granulate toward the burner - stop by pressing the STOP button.
11. After installation, connection and start-up of the burner, the Installer should train the User in terms of correct operation of the device, independent setting of basic parameters of the burner, cleaning and procedure in emergency situations (no fuel, filling of the feeder, setting the sensitivity thresholds of the flame sensor/photocell/other).



The minimum distance from the end of the furnace to the opposite wall of the combustion chamber should be kept.

## 5. Operation

Below the burner operation has been discussed with control by RK KEY. In the case of use of other control functions authorized by the manufacturer, please use the control manual.

After activation of the power supply, the governor displays the name and version of the device and then moves to the condition in which it was before the activation or loss of electric power supply.

The face plate of the governor (figure 1) consists of the following elements:



Rysunek 1. Face plate of RK-2006LPG2 controller.

- |   |  |
|---|--|
| 1 –display,   | 4 – boiler controller knob and knob for parameter setting including the OK button, |
| 2 –STOP button, buton for alarm reset and cancellation of introduced changes, | 5 – MENU buton and buton for parameter selection,                                  |
| 3 – START buton and buton for parameter selection,                            | 6 –ESC buton.  |

The basic operation of the device consists in setting the boiler preset temperature. For this purpose, the correct value should be set by turning the boiler governor knob (4) and approved using the OK button (pushing the knob).



**NOTE!** If the input of the room thermostat operates in the adaptive mode, the attempt to change the preset boiler temperature may not be successful, i.e. after approval of the new value, the regulator may automatically change the preset boiler temperature to the value which results from the adaptive algorithm.



**NOTE!** If the heating system is provided with a domestic hot water bunker, water temperature in the boiler maintained by the regulator during bunker preheating may be higher than the temperature preset with the thermostat knob.

## 5.1 Display symbols.

### 4. Description of display symbols.

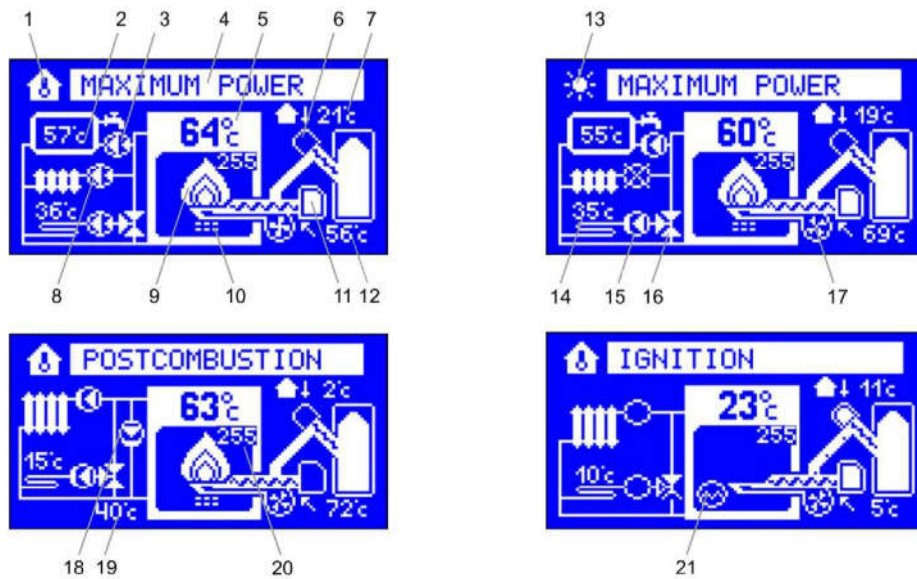

- 1 – Thermostat work indicator,
- 2 – DHW temperature,
- 3 – DHW pump work indicator,
- 4 – Controller work mode,
- 5 – Boiler water temperature,
- 6 – Feeder work indicator,
- 7 – The outdoor temperature,
- 8 – CH pump work indicator,
- 9 – Burner capacity indicator (the higher the capacity, the brighter the flame),
- 10– Cleaning device work indicator,
- 11– Stoker work indicator,
- 12– Feeder temperature,
- 13– The operation indicator summer mode,
- 14– The temperature circuit 2,
- 15– The operation indicator circuit pump 2,
- 16– The operation indicator mixing valve,
- 17– Fan,
- 18– Mixing pump work indicator,
- 19– Return water temperature,
- 20– Flame radiance intensity in boiler furnace/ burner temperature,
- 21– Ignitor work indicator.

## 6. Start-Up

1. Check the granulate condition in the tank (bunker). If there is no fuel - make-up the tank.
2. Fill the feeder with granulate **until pellet is transferred to the burner**, in order to start the filling function press the **START** button for approx. 5 seconds (until the FILLING message is displayed). The first feeder filling may last from several to dozen minutes. The controller will automatically stop the filling process after 10 minutes. If the feeder is still not full (pellet has not been not transferred toward the burner), filling should be repeated. The filling process can be interrupted at any time by pressing the **STOP** button.
3. Check the status of the set basic parameters:

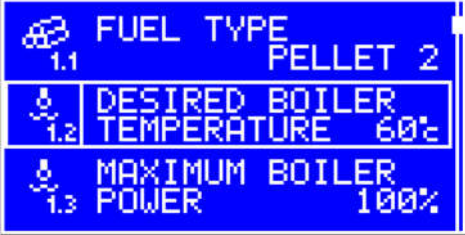
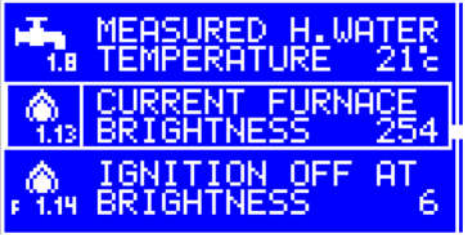
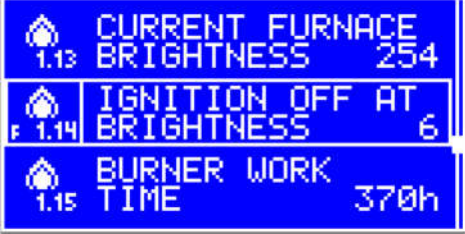
Another pressing of <>	Display status (example) for RK-2006LPG controller	What does it mean?	Comments:
1	BOILER PRESET TEMPERATURE 	Boiler setpoint temperature	
2	CURRENT FURNACE BRIGHTNESS 	Current value at the photocell - when it is not on, it amounts to 0	Varies depending on the brightness in the combustion chamber ranging from 0 to 254
3	IGNITION OFF AT BRIGHTNESS 	Setpoint of the values for the fired status - on	Brightness value which should be set depends on the type of the detector used. It amounts to : 5-10 for NSL 4960 sensor 10-20 for NSL 6940 sensor 40-50 for NSL 6910 sensor

4. Press the **START** button. Burner starts operation.

**Note:**





If, for any reasons it will be returned to the setpoints of the manufacturer in the service menu, then in addition to settings in the service menu of flame detection method, protections, parameters of fuel and air /and other/ feeding, always remember to set the photoelement sensitivity thresholds in the user menu according to the above table.

- Fill up water in the district heating system.
- Remove any flammable materials from the boiler house.
- Set all the governors (room thermostats, remote circuit breakers, etc.) in *max/on/* position - the room governor is superior in relation to the controller. If room thermostat is not used its output must be shorted in the control box - G-H terminals.
- Good ventilation of the boiler house must be ensured, bearing in mind that the cross-section of the ventilation opening must be of min. 50% of the cross-section of the stack.

## 6.1 Execution of the controller function

The burner is started with short pressing of the START button on the controller panel. In the first phase, the control lights activate and the fan is switched on to purge the combustion chamber.

After preparation of the boiler combustion chamber, the start-up dose of fuel (granulate) is fed and the igniter is switched on. The igniter needs 60 - 90 seconds to fire the fuel. After detecting a flame - i.e. after exceeding the set brightness threshold by the sensor (photocell), the igniter will be switched off and the burner will move to automatic operation mode, which is indicated by displaying a relevant text on the controller - MAXIMUM POWER, MODULATED POWER or MINIMUM POWER. In the case of brightness decrease in the combustion chamber to the value of the firing threshold, the igniter is activated for repeated firing of the fuel. The operating status of the device can be evaluated on the basis of the displayed message:

<b>Display status</b> RK-2006LPG	<b>Action</b>
	Controller switched off, resumption of operation by pressing the START button
	Manual filling of the fuel feeder. Burner control stopped.  The governor controls operation of the district heating and domestic hot water pumps, but does not start automatic firing.



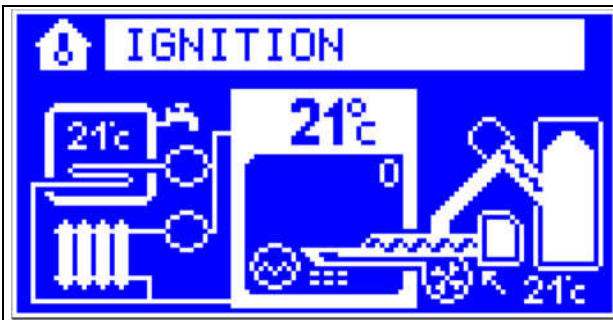

The controller is in the course of automatic burner firing.



Control of the fan and the feeder in a manner allowing for stabilization of the burner operation.

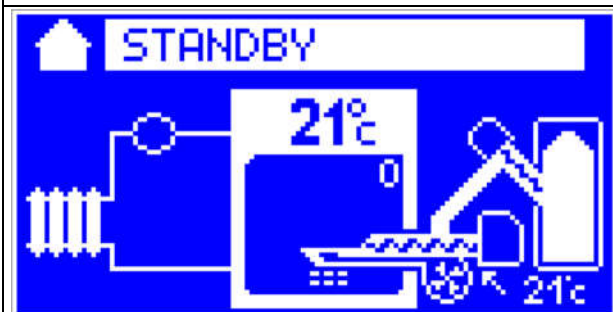

The controller controls operation of the district heating and domestic hot water pumps. In the case of heat demand, it attempts to automatically fire the burner

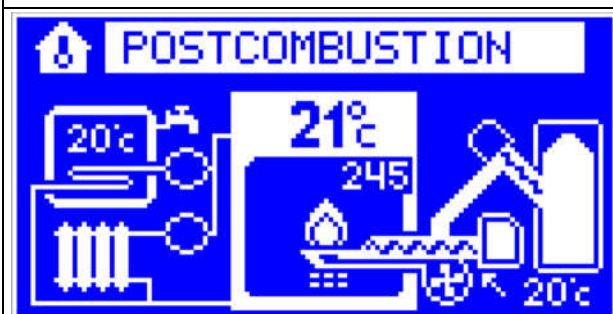

No heat demand or the need to clean the furnace. The controller switches off the feeder and starts secondary combustion of fuel until the flame decays.

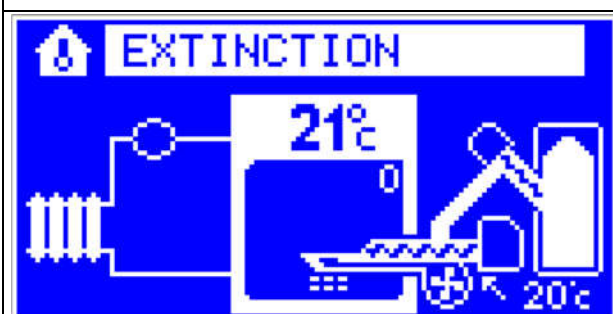

The controller flames out the furnace in the burner..

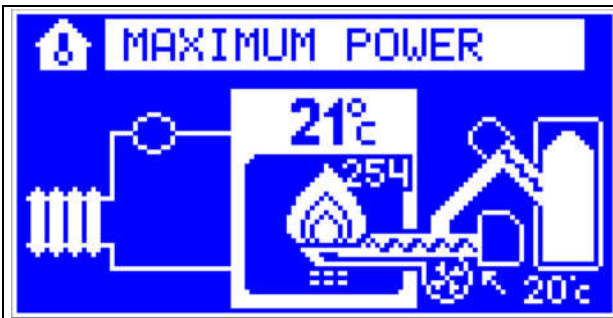

Control of the fan and the feeder in a manner enabling achievement of maximum power of the burner.

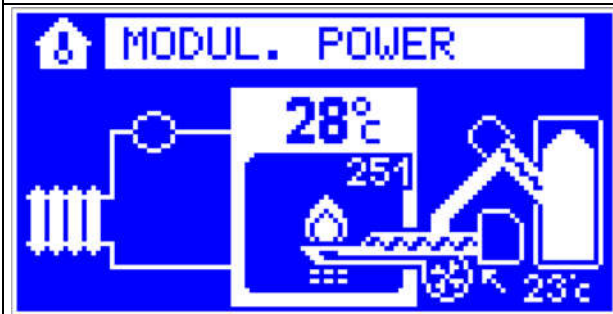

The controller reduces the amount of fed fuel as the water temperature in the boiler approximates the preset value.

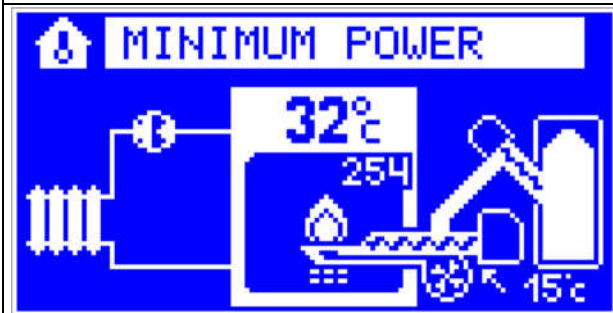

Control of the fan and the fuel feeder in a manner allowing for burning maintenance.



Cleaning of the furnace.

## 6.2 Diagram of controller connection to ECO-BURNER

### 6.2.1 RK-2006LPG2 controller connection diagram

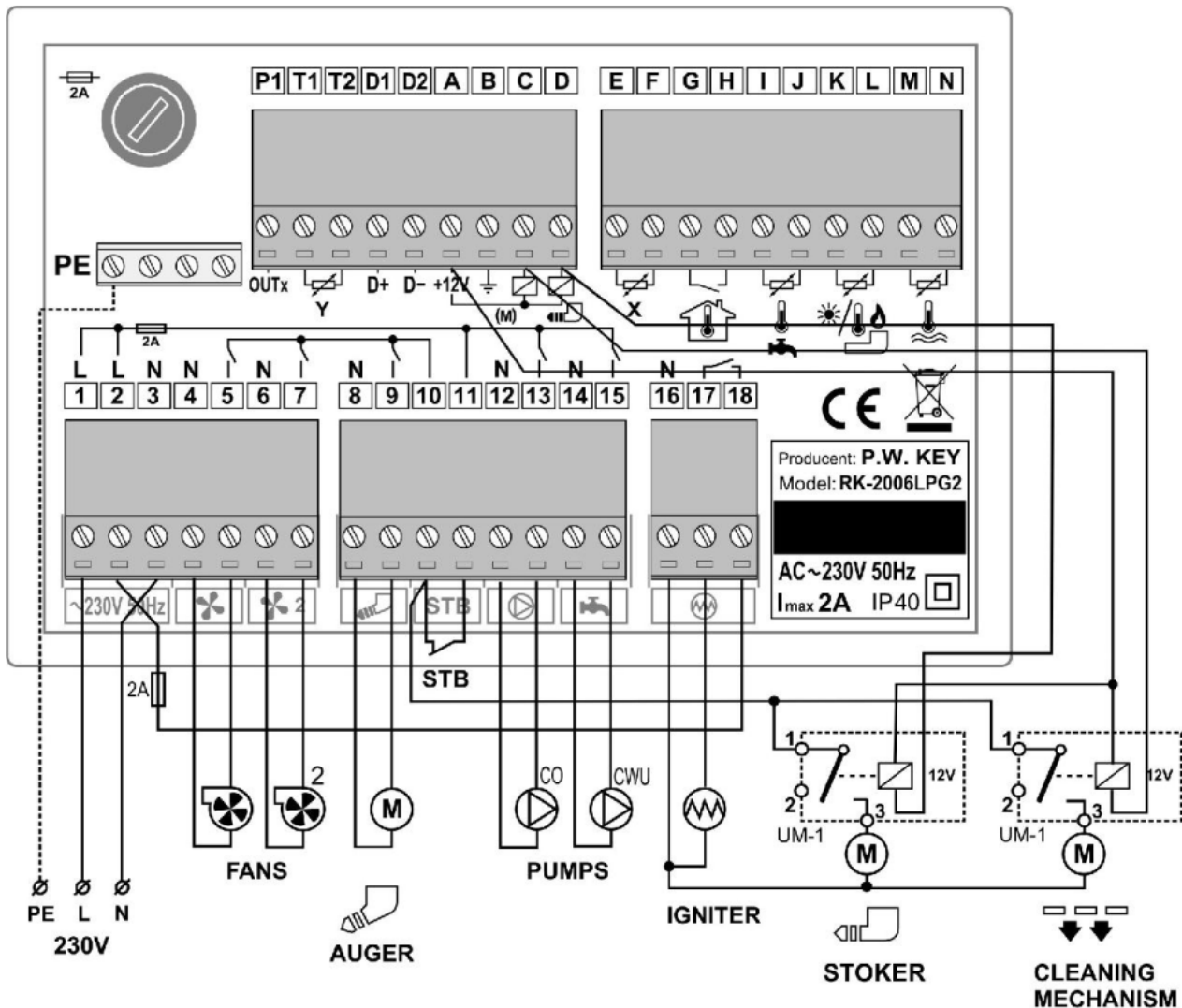

Low voltage strip - control:

A-D – connection of the relay activating the stoker (infernial feeder of the burner),  
 A-C - connection of the relay activating the mobile grate (automatic cleaning),  
 E-F – burner temp sensor ,  
 G-H – room thermostat  
 I-J - domestic hot water temperature sensor  
 K-L - photocell (optionally - Pt-1000 sensor or burner temperature sensor)  
 M-N - boiler temperature sensor,

Listwa prądowa - wg schematu.

12-13 - brown - blue - district heating pump connection output  
 14-15 - gray - green - domestic hot water pump connection output

Protective strip - PE

Connect all the yellow and green cables.

## 6.2.2 Schemat elektryczny regulatora RK-2006SPGM

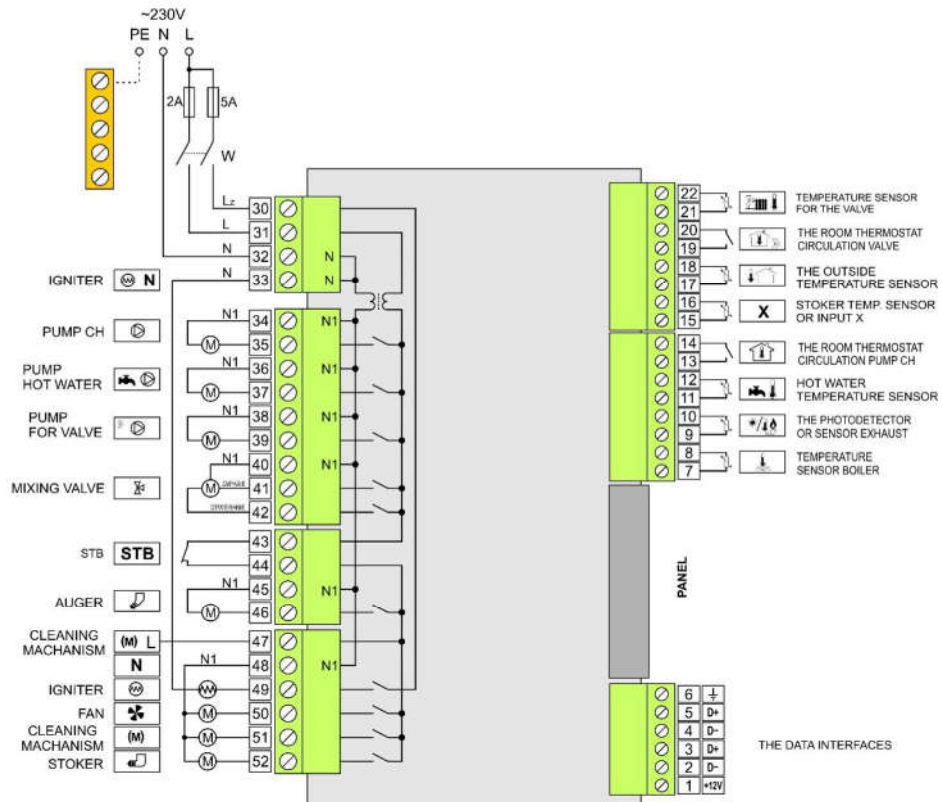

Figure. RK-2006SPGMS Controller connection diagram.

### Input/Output diagram RK-2006SPGM

Listwa niskonapięciowa – sterująca:

- 1-6 –RS485 data transmission connection
- 7,8 – Boiler temp sensor
- 9,10 – Photodetector
- 11,12 – Domestic hot water temp sensor
- 13,14 – Room thermostat input
- 15,16 – Stoker temp sensor (a tour premises, it is the burner sensor)
- 17,18 – Outside temp sensor
- 19,20 – Circulation thermostat input with a valve
- 21,22 – district heating temp sensor downstream the valve

Power strip – acc. To the diagram:

- 30,31 – controller L input
- 32 – controller N input
- 33 – igniter N output
- 34 – district heating pump N output
- 35 – district heating pump L output
- 36 – domestic hot water pump N output
- 37 – domestic hot water pump L output

- 38 – N output for the pump downstream the mixing valve
- 39 – L output for the pump downstream the mixing valve
- 40 – N output for the mixing valve
- 41 – L output to close the mixing valve
- 42 – L output to open the mixing valve
- 43,44 – STB output
- 45 – external feeder N output
- 46 – external feeder L output
- 47 – constant cleaning mechanism L output
- 48 – burner N output
- 49 – igniter L output
- 50 – fan L output
- 51 – cleaning mechanism L output
- 52 – internal feeder (stoker) L output

Protective strip - PE

Connect all the yellow and green cables.

6.2.3 Controller connection diagram RK2006-LPG2 for burner 100-250kW

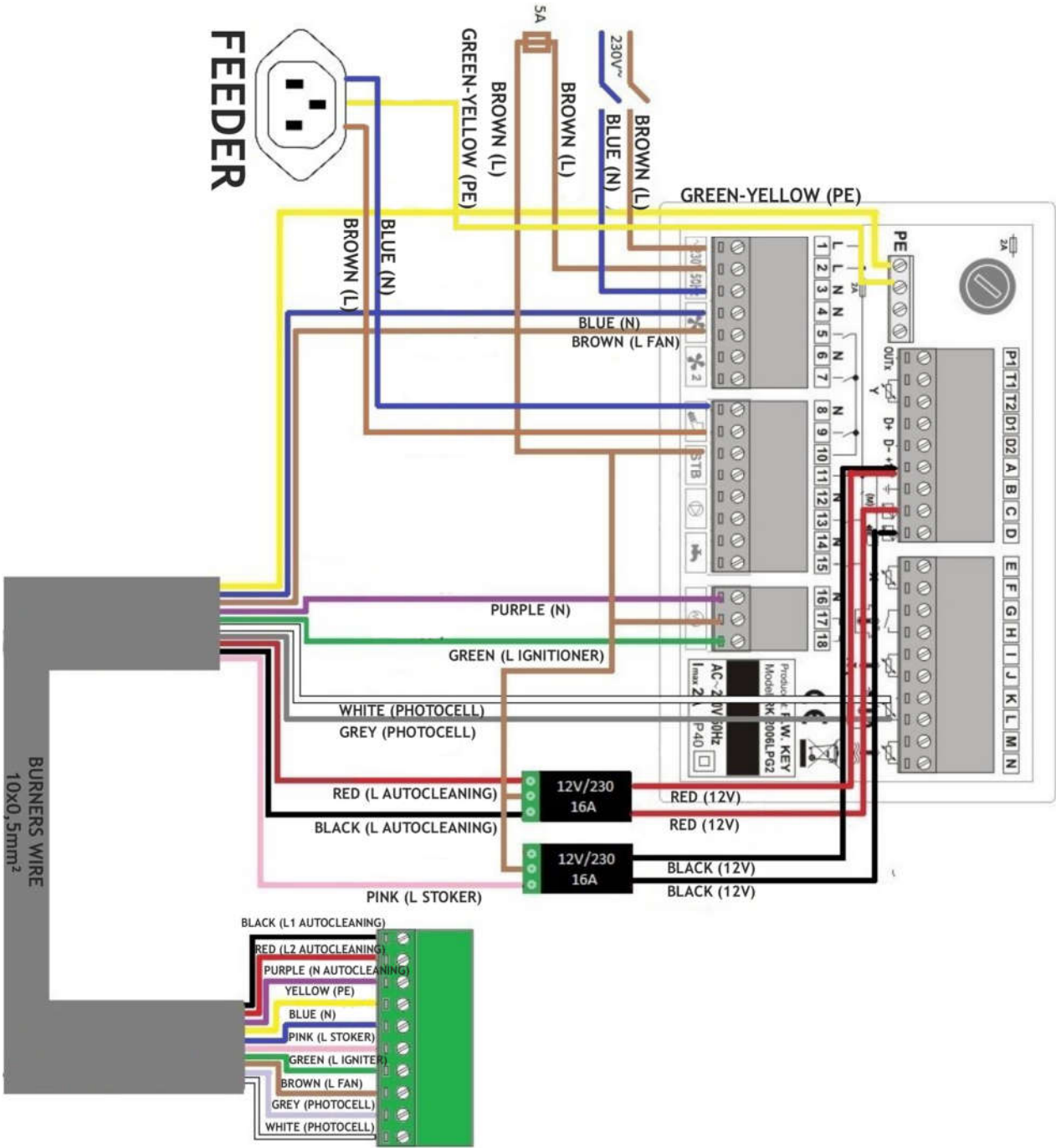

### 6.2.1 Controller connection diagram RK2006-LPG2 for burner 300-1000kW

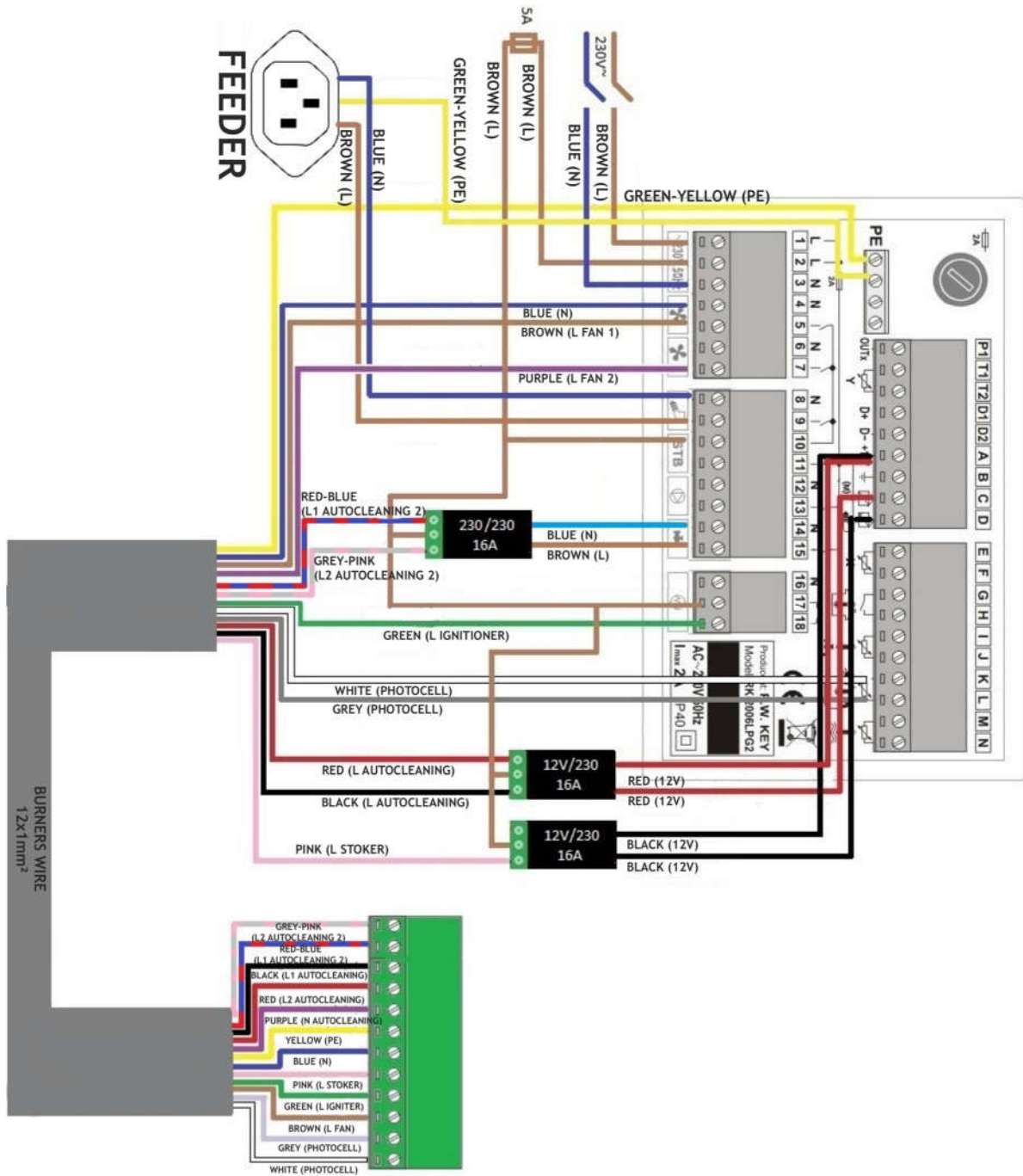

6.2.2 Controller connection diagram PLUM 850P-O (optional)

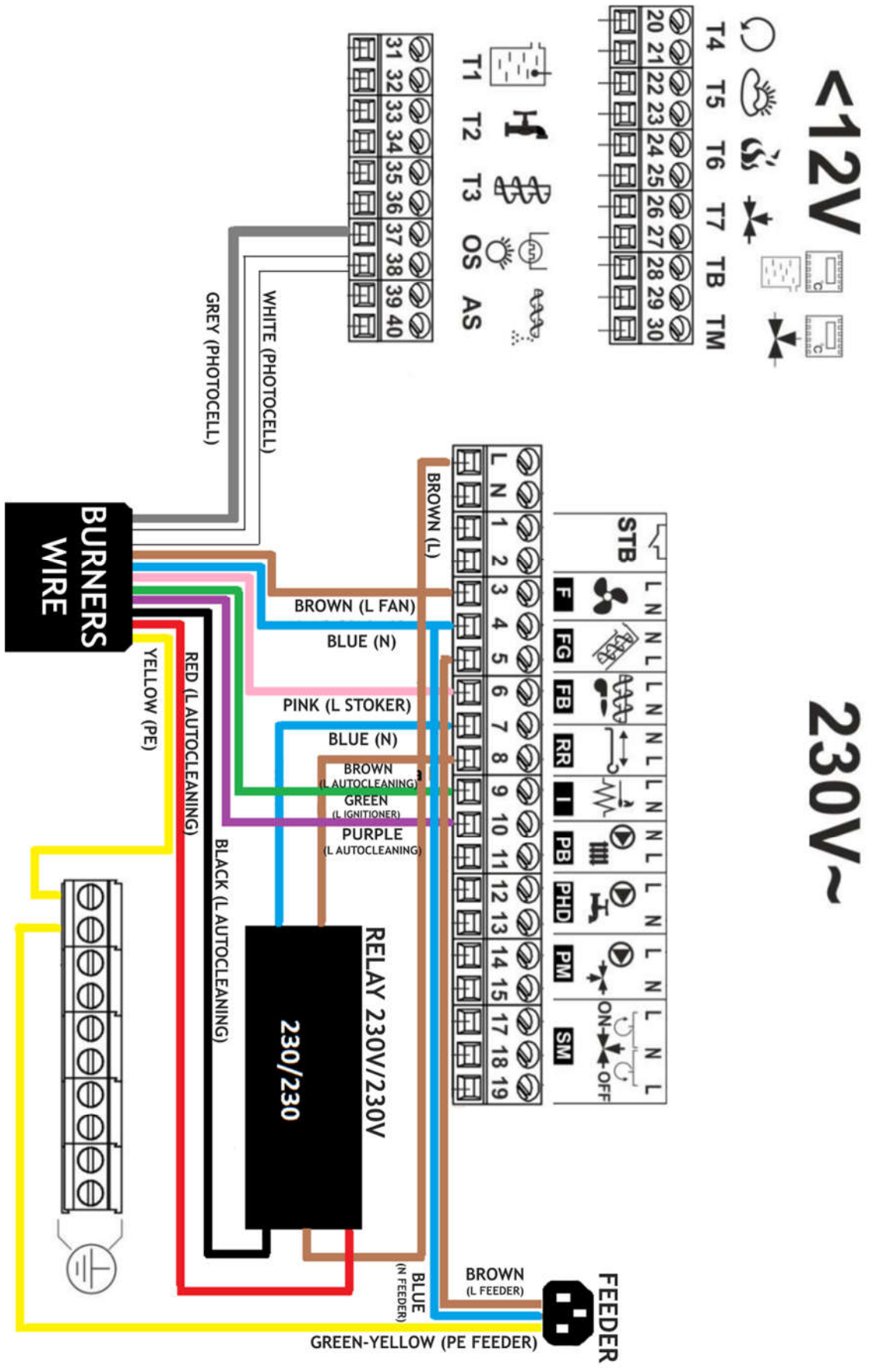

6.2.3 Control board for 100-250kW burners

# CONTROL BOARD - CIRCUIT DIAGRAM

NOTE: PAY ATTENTION TO CORRECT CONNECTION OF THE SO CALLED "PHASE" - L TERMINALS

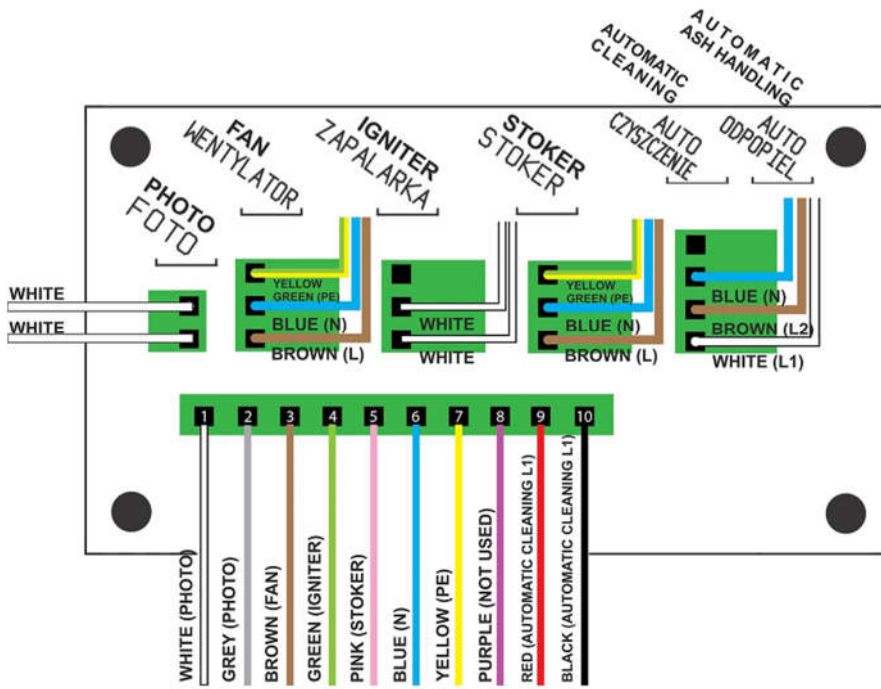

6.2.4 Control board for 300-1000kW burners

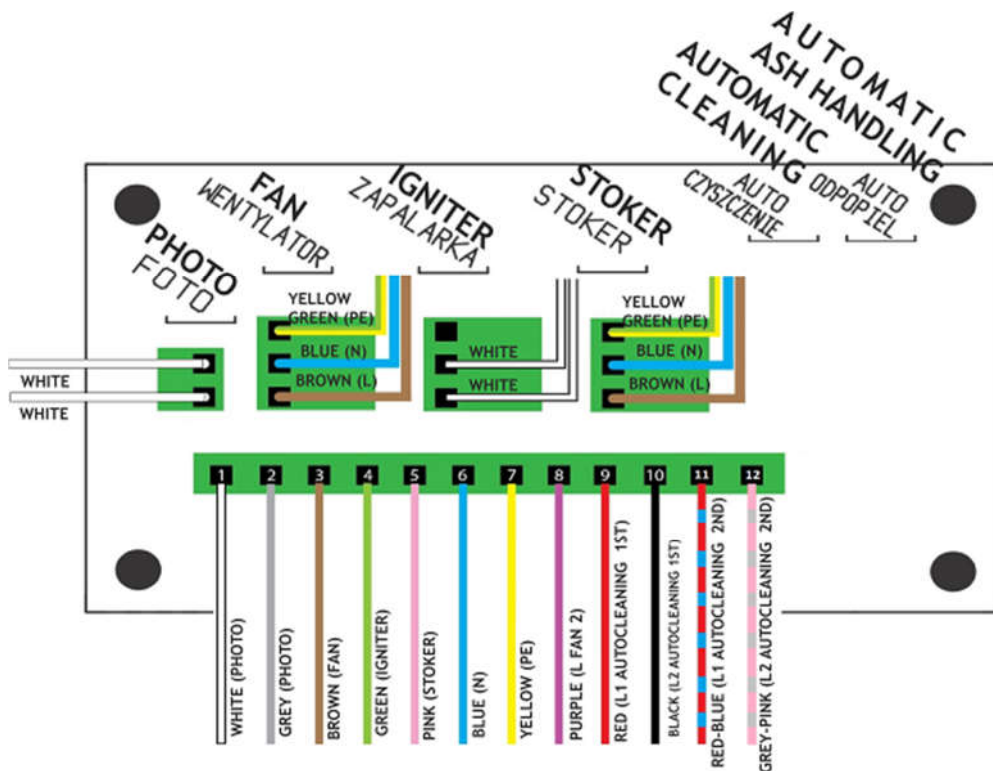



## 7. Preliminary settings of the manufacturer – basic parameters of the burner

1	Max power [kW]	100	150	200	250	300	400	500	750	1000	
2	Dosing feeder motor	25W 50K	25W 50K	25W 50K	25W 50K	125W 36K	125W 36K	180W 36K	180W 36K	180W 36K	
3	Fan rotational for firing	Individual settings adjusted to boiler and burner requirements									
4	Fan rotational for max. power	Individual settings adjusted to boiler and burner requirements									
5	Fan rotational for min. power	Individual settings adjusted to boiler and burner requirements									
6	Start-up fuel dose	5 sec.									
7	Fuel dose for max. power	See chapter 10									
8	Fuel dose for min. power	10%									
9	Stoker operation type	Auto									
10	Furnace flameout time	15 min	15 min	15 min	15 min	20 min	25 min	30 min	45 min		
11	Power of UPS	500W/800W				1000W/1500W					
12	Min. Capacity of UPS	30Ah				100Ah					

**NOTE:**



For burners with an external combustion chamber(UMO series) emergency power supply is recommended in the event of a power failure.



**The manufacturer is not responsible for damages resulting from a power failure.**

## 7.1 Setting of the parameter "Fuel dose for the maximum power"

Burner power depends on the amount of combusted pellet. The "Fuel dose for the max/min power" and the "Boiler horsepower" are the parameters controlling the power. In order to start power control, the feeder capacity should be known. Capacity is provided in kilograms per hour (kg/h).

a) Feeder capacity formula

$$\text{Feeder measurement in kg} * \frac{60\text{min}}{\text{measurement time}} = \text{Feeder output for 1h}$$

Where

**Feeder measurement** - we conduct the measurement for a filled feeder during a specified measurement time (e.g. 2 or 3 minutes).

b) Then, power shall be calculated which will be provided by the specified fuel amount

$$\text{Feeder output for 1h} * (\text{pellet net calorific value} * 0.277\ 777\ 777\ 8) = \text{Power achieved from fuel}$$

where

$$0.277\ 777\ 777\ 8\ \text{kW} - 1\ \text{MJ}$$

Another issue is to consider capacity in the power achieved from fuel

$$\frac{\text{Power from fuel} * \text{efficiency}}{100} = \text{Power with the consideration of capacity}$$

Where

**Power with the consideration of capacity** – Maximum power which can be achieved from a given feeder

Example of capacity calculation.

Let us assume that our feeder fed 1kg of pellet within 3minutes of operation.

$$1\text{kg} * \frac{60\text{min}}{3\ \text{min}} = 1\text{kg} * 20 = 20\ \frac{\text{kg}}{\text{h}}$$

Then

$$20\ \frac{\text{kg}}{\text{h}} * (19\text{MJ} * 0,277\ 777\ 777\ 8) = 105,56\text{kW}$$

Then

$$\frac{105,56\text{kW} * 90\%}{100} = 95\text{kW}$$

The result indicates that feeder is able to feed fuel with the maximum value of 95kW.

### Concept of percentage dose for power.

Doses for the individual power values are determined by means of percentage values. This means that if we took our sample feeder setting of the parameter „Fuel dose for maximum power” at 100% will result in burner operation at 95kW.

Following this concept, it is quite easy to calculate the percentage value for other power values according to the principle of proportion

$$\frac{25kw}{95kw} = \frac{x\%}{100\%} \rightarrow x = \frac{25kw * 100\%}{95kw} \rightarrow x \approx 26\%$$

Based on this proportion, it can be calculated that setting of the parameter „Fuel dose for maximum power” for this burner is 26%

There are two possibilities of changing power parameters:

- 1) Change of the parameter „Fuel dose for maximum power”, which functions as above,
- 2) Change of the parameter „Boiler horsepower”, which is determined based on percentage values and calculated based on the parameters „Fuel dose for maximum power” and „Fuel dose for minimum power”, consists on calculating percentage values according to the principle of proportion as follows :

$$\frac{25kW - 100\%}{10kW - x}$$

$$\frac{25kW - 100\%}{10kW - 40\%}$$

## 8.Elements of pellet burner protections

Protection	Protection type
Protection against External ignition	Feeder dosing the pellet to the burner gravity
	Spiro pipe and strain relief connecting the feeder with the burner are at all Times empty and made of non-flammable materials
	Spiro pipe is made of polyurethane – non-flammable and self-extinguishing – the resistance from -40 to 70°C
	Fire damper protecting against flashing back of flame and gas
	Feeder (strain relief) temperature sensor, set at 45°C.
Protection against power failure	Emergency power supply recommended.
Protection against flame decay	Use of photocell

## **9. Recommendations**

1. Maintain the burner furnace grate clean, remove combustion residues (ash, slag) at least once a week. If necessary, clean the furnace more often - depending on the quality of used granulate.
2. Remove combustion residues from above and under the grate.
3. During each cleaning check the air admittance openings in the grates and the furnace slab in terms of blockages.
4. It is recommended to commission inspection to an authorized service once a year, after the heating season.
5. Maintaining the boiler house room clean.
6. Protection of supply of sufficient air amount to the boiler house.
7. Ensuring that there are no blockages in the ventilation ducts.
8. Use of suitable and clean fuel.
9. In the case of change of pellet delivery, check if combustion is correct and adjust the setpoints.

# 10. Conditions of proper and safe operation

In order to maintain optimum and safe operating conditions of the boiler/burner, the following principles should be observed:

1. The burner can be operated only by adults trained in the scope of operation and maintenance of pellet burners.
2. Prior to commencement of boiler operation, it is absolutely required to read the operation manual of the burner.
3. It should be ensured that the burner is located away from children.
4. It is prohibited to insert hands in the fuel bunker - it can cause serious injury.
5. The burner, feeder, boiler and the district heating and domestic hot water system should be kept in good technical condition.
6. The burner is a device producing thermal power. It should be noted that some elements of the burner heat up to high temperatures.
7. Order should be maintained in the boiler house and materials not related to operation of the boiler and flammable materials should not be stored therein.
8. Only the fuel recommended by the Manufacturer should be used.
9. The electronic and automation system elements and other electronic equipment related to the burner should not be interfered in.
10. The electrical system in the facility where the burner is located must be made in accordance with the applicable regulations and safety rules.
11. Soot and ash should be removed from the burner and the boiler during outage of the boiler.
12. It is not allowed to burn in the burner materials not intended for this purpose.
13. Appropriate amount of fresh air should be ensured in the boiler house.
14. During operation of the burner, the boiler door with the installed burner must not be opened.
15. In the case of fuel ignition inside the burner part not intended for this purpose, the device should be disconnected from the power supply and then the extinguishing should be started.
16. The burner must not be exposed to water, which may cause electric shock. The burner should be protected against rain and any leakage from the water system.
17. The burner should be stored and used in the rooms with the temperature ranging from +10°C to +40 degrees Celsius and with adequate humidity.
18. It is not allowed to install and use the burner in the boilers and other systems not intended for this purpose.
19. The burner is a device intended for installation in the district heating boilers and may not function as an independent device.
20. It is not allowed to fire the burner using other methods than those described in the manual. It is particularly forbidden to use flammable agents.
21. The burner should be operated with the covers in place and all the elements ensuring proper functioning of the device.



**It is forbidden to use the burner without the covers installed.**

# 11. Cleaning and maintenance

**UNI-MAX O version burners** - are provided with mobile grate in the form of a drawer which maintains stable combustion conditions in time and removes the excess slag from the furnace. In order to remove and clean the grate, the cover should be removed from the burner, the cable marked as automatic cleaning of the grate disconnected from the control board and the clasps located on the burner sides undone. Then the drawer should be gently withdrawn and cleaned of ash and slag.

Once the drawer has been cleaned, it should be gently re-inserted in the burner, Once the grate has been carefully inserted, the clasps should be done, the cable for automatic grate cleaning connected and the cover put on. It is recommended to remove the grate for cleaning once a week/month.



## NOTE!

The frequency of grate cleaning depends on the quality of combusted pellet.



## NOTE!

In order to clean the burner, switch off the equipment and wait until the temperature in the furnace drops.



This operation should be carried out with particular care and only by persons who have read the operation manual.

## 11.1 Grate cleaning

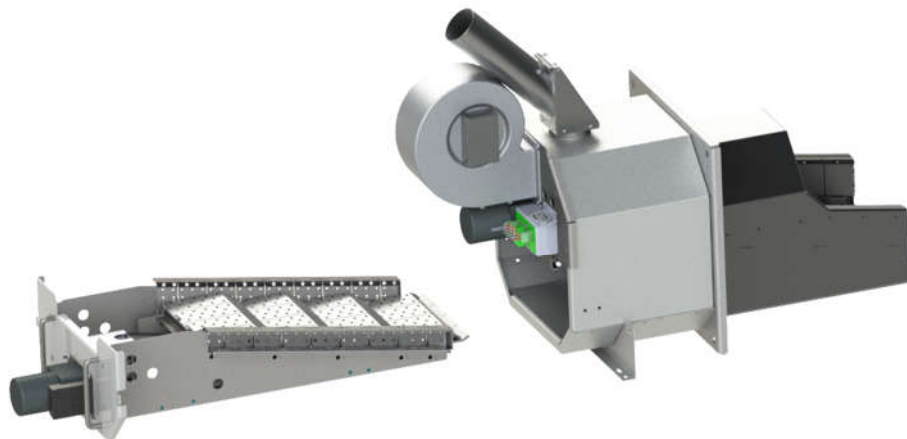

In order to clean the grate, the clasps located on the sides of the device and cables connected to the electric plate should be undone. Then, the grate should be pulled out and ash removed, which is located on the grate and in the drawer underneath it.

It is very important that the air admittance openings are not blocked, which has an impact on the amount and the quality of fuel combustion. It is particularly important that the openings are not blocked. They are located both in the grate and the furnace slab. It is recommended to clean the openings in the grate during each burner cleaning and clean the openings in the slab once a season (or more frequently if required). Clear openings on the slab may have an impact on flame detection by the photodetector.

## 11.2 Igniter replacement

Worn element subject to the greatest loads - igniter - is the most frequent reason for the Eco-burner servicing.

Before the igniter replacement is commenced, it should be checked whether it is not sufficient to replace the fuse protecting the firing system. In addition to the lack of firing, simultaneous lack of fuel feeding (the feeder spiral is not turning, despite the fact that the LED signaling fuel feeding is active) is a characteristic feature of such defect. In such case, the controller should be disconnected from the power supply and the fuse insert unscrewed. After unscrewing, it should be checked if the wire inside the fuse is not broken. If it is broken, the fuse should be replaced and the igniter tested again.

### I. Remove the burner cover

Prior to commencement of work, the device should be disconnected from the power supply and the casing removed from the burner.

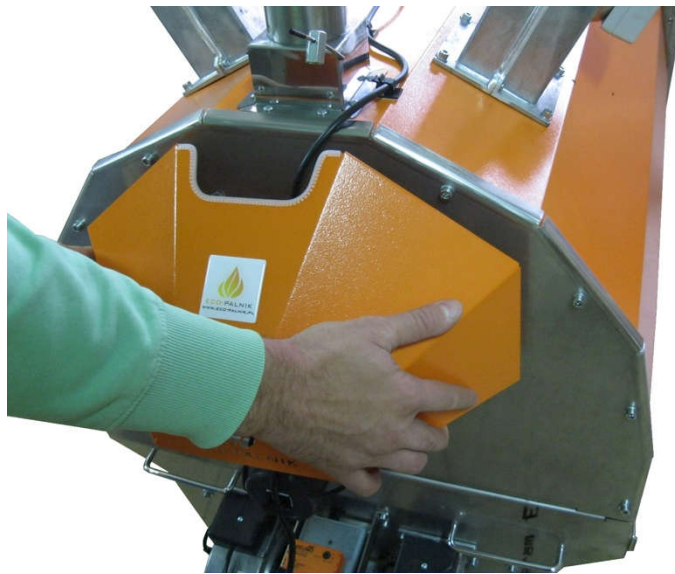

### II. Igniter removal

Then, the igniter plug should be gently removed from the electric plate and the igniter rubber gland pulled out.

Once the gland has been removed, the igniter should be gently removed from the holder.





### **III. Inserting of an efficient igniter**

When inserting a new igniter, ensure that it is inserted in the holder and handled with care. The igniter should be pushed as far as the end.



### **IV. Assembly**

Once the igniter has been installed, the remaining components should be assembled in reverse order to removal.



## 11.3 PHOTOCELL CLEANING

In the course of combustion, ash, soot and other impurities settle on many components of the burner. In the case of problems with flame detection, the photocell should be cleaned.

### I. Remove the burner cover

Prior to commencement of work, the device should be disconnected from the power supply and the casing removed from the burner.

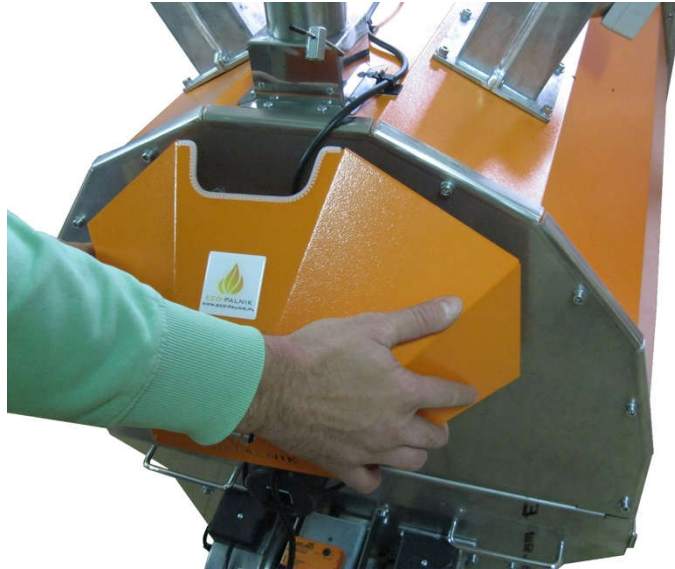

### II. Disconnection of the photocell from the electric plate and removal from the tee casing

Once the casing has been removed, the plug should be gently removed from the electric plate and then the rubber gland should be pulled out in which the photocell is mounted.

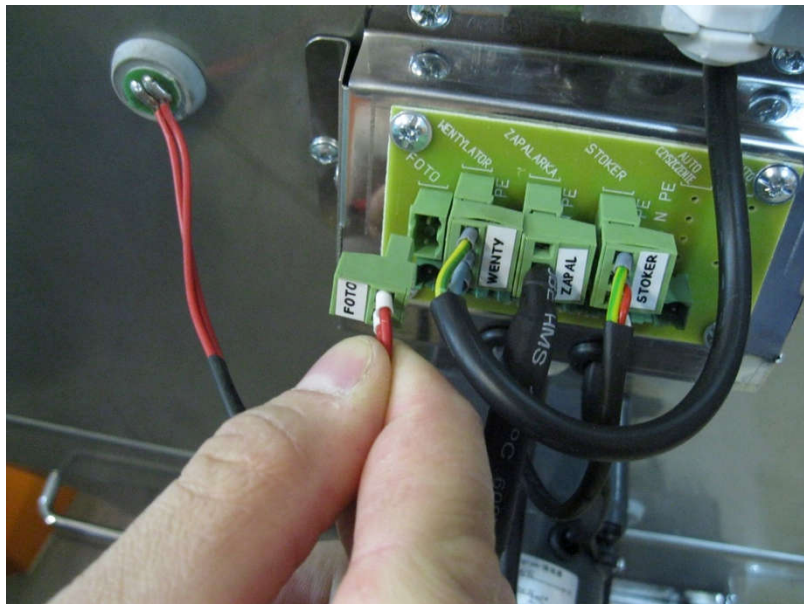

### III. Photocell cleaning

Once the photocell has been removed, it should be gently wiped with a cloth or toilet paper, until the winding is clearly visible through the glass.

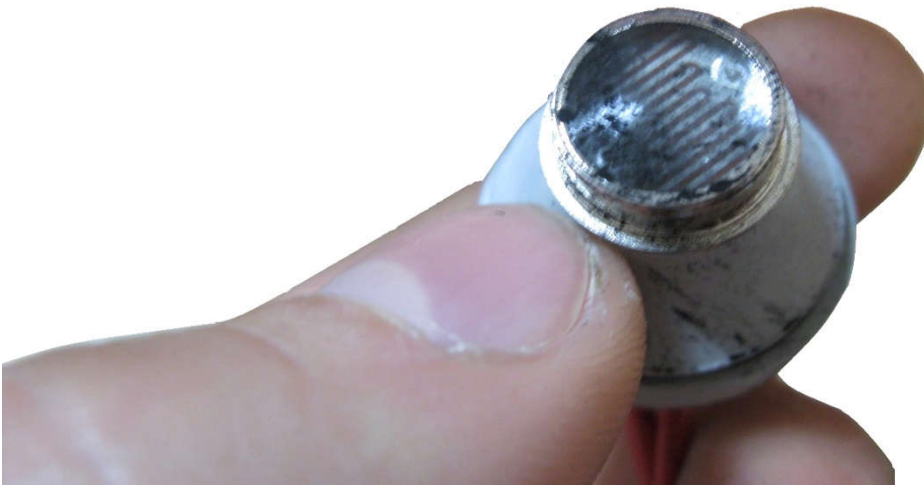

#### **IV. Assembly**

Once the photocell has been cleaned, it should be installed in reverse order to removal.

## 12 Removal of burner after expiry of its service life

The burner and its individual parts for the production of which metals are used should be removed by authorized companies, ensuring purchase of recyclables or other companies specializing in neutralization of such equipment with absolute compliance with the environment protection rules.



## 13 DEFECTS

ITEM	Defect	Cause of defect occurrence	Method of defect removal
1	NO FUEL alarm	No fuel in the bunker	If during operation in the FIRING mode, the governor does not detect the flame for the duration specified by the service technician, the no fuel alarm is activated. In order to restart the governor, the fuel should be made up, the alarm canceled using the <b>STOP</b> button and the control process started using the <b>START</b> button.
		Damaged igniter	Replace the igniter insert.
		Slag in furnace	Thoroughly clean the furnace and clean the openings supplying air in the furnace.
		The igniter, stoker, feeder does not work	Replace the fuse located in the vicinity of the controller for a new one with the value of 5A (5 x 20).
		Feeder does not work	Check the feeder condition in terms of blockages.
		Photocell does not detect fire	Wrong photocell calibration, reset firing thresholds.
			Photocell is contaminated, which may result in incorrect readings, clean the photocell.
			Zbyt duża ilość paliwa lub paliwo złej jakości – zmniejszyć: dawkę startową i/lub dawkę paliwa dla rozpalania
Photocell is broken – replace the photocell			
2	The burner is often in firing condition	Incorrectly selected parameters of flame detection	Set the correct parameters or contact the manufacturer's service
		Contaminated photocell	Remove and clean the photocell
		Contaminated furnace	Thoroughly clean the furnace and clean the openings supplying air in the furnace

		Too small fuel doses	Increase the parameters for the minimum power of the device
		Too large fuel doses	Reduce the parameters for the maximum power
		Contaminated furnace slab	Thoroughly clean the slab downstream the furnace and clean the openings supplying air in the furnace
3	Feeder ignition alarm	Excessive temperature increase in the burner casing caused by fuel ignition in the stoker tee or the feed pipe	<p>If the feeder is equipped with a temperature sensor, exceeded programmed value in the service parameter FEEDER IGNITION TEMPERATURE will cause activation of the feeder ignition alarm and the regulator will switch to the EXTINGUISHING mode</p> <p>NOTE! This alarm can be canceled once the feeder temperature has been lowered. The attempt to cancel the alarm before completion of extinguishing deactivates the sound signal only.</p>
4	Boiler overheating alarm	Exceeding of water temperature in the boiler set by the service technician in the controller	RK-2006SPGM governor is equipped with a boiler overheating protection. If the water temperature in the boiler reaches the value programmed in the service parameter "Maximum temperature of the boiler", the governor will activate the district heating pump. Increase in water temperature in the boiler to the value programmed in the service parameter "Overheating temperature of the boiler" will result in deactivation of the fan, activation of the district heating pumps, switch of the governor to the STOP mode without starting the flameout process and activation of the alarm:
5	Temp sensor is broken	Damage to the sensor circuit or temperature outside the measuring range of -9°C - 109°C	Contact the manufacturer's service if the error message is not canceled after pressing the STOP button, replace the sensor
		Damage to the feeder temperature sensor	In the case of damage to the feeder temperature sensor, similarly as in the case of ignition, the governor performs the extinguishing procedure and activates the appropriate alarm NOTE: Contact the manufacturer's service in order to remove the sensor failure if the error cannot be canceled.
		Damage to the circuit of domestic hot water temperature sensor results in the deactivation of the domestic hot water control	If the heating system is equipped with domestic hot water circulation, then in the case of the domestic hot water sensor damage the governor deactivates the domestic hot water pump and activates the alarm Note: Contact the manufacturer's service in order to remove the sensor failure

		Damage to the burner temperature sensor	In the case the temperature flame detector (CT-1/2 or PT-1000) is connected to the governor, its damage will activate the appropriate alarm and switch the device to the STANDBY mode. NOTE: Contact the manufacturer's service in order to remove the sensor failure
6	The burner smokes, soot is formed	Too large fuel feeding in relation to the air, Contaminated burner furnace, slag on the furnace.	Clean the furnace, check the air admittance openings in terms of blockages. Adjust the burner - fuel and air to the maximum and minimum power.
7	Slag is too often formed on the furnace - the burner does not clean automatically.	Inappropriate fuel, with improper parameters.	Change the pellet supplier.
8	The feeder does not feed fuel.	The pellet container is empty	Add fuel to the container
		The feeder is blocked by trash from fuel	Empty the container and feeder, and remove foreign objects from them
		The auger inside the feeder stretch out	Stretch out of auger is natural process and it need to be shortened about 1-2 cm. The auger need short than feeder pipe about 1-2 cm.
		The feeder is out of power	The power cable must be connected to the feeder. If it still doesn't work, check the STB and fuse.
		Dust at the fuel inlet point in the pellet container	Empty the container and clean the fuel inlet point
9	The controller works despite no flame	The photocell is broken	Replace the photocell
		Parameter IGNITOR TURN-OFF DEPENDING is too low	Parameter Ignitor turn-off depending need be higher
		Photocell inserted incorrectly or Pulled out of the mounting hole	Insert the photocell correctly into the appropriate hole
		The photocell can see external light (sunlight, lamp light, etc.)	Access of external light radiation must be blocked to the aeration chamber by means of a mounted photodetector

## 14 SPECIMEN OF THE TYPE PLATE

 <b>ECO-PALNIK</b> <i>Sklep</i>	
ZPD "SKIEPKO" ul. Kolejowa 33 29-100 Włoszczowa, POLSKA <a href="http://www.eco-palnik.pl">www.eco-palnik.pl</a> tel. +48413945518	
Palnik na pellet do kotłów C.O.	
Typ:	PLUS <input type="checkbox"/> PERFECT <input type="checkbox"/>
	UNI <input type="checkbox"/> VIP <input type="checkbox"/>
	UM <input type="checkbox"/> BIO <input type="checkbox"/>
Numer seryjny:	
<input type="text"/> <input type="text"/> <input type="text"/> <input type="text"/> - <input type="text"/> <input type="text"/> <input type="text"/> - <input type="text"/> <input type="text"/> -	
<input type="text"/> <input type="text"/> <input type="text"/> <input type="text"/> - <input type="text"/> <input type="text"/> <input type="text"/> <input type="text"/>	
Rok prod.:	2018
<b>Podstawowe parametry:</b>	
PALIWO: pellet drzewny 6-8 mm	
NAPIĘCIE ZASILANIA:	[V] <input type="text" value="-230"/>
MOC ZNAMIONOWA:	[kW] <input type="text"/>
ZABEZPIECZENIE:	[A] <input type="text" value="5"/>
MOC ZAPALARKI:	[W] <input type="text" value="170/300"/>
KLASA OCHRONY:	<input type="text" value="IP41"/>
	

Serial number:
<input type="text" value="2601"/> - <input type="text"/> <input type="text"/> <input type="text"/> <input type="text"/> - <input type="text"/> <input type="text"/> - <input type="text"/> <input type="text"/> <input type="text"/> <input type="text"/>



**ECO-PALNIK**  
*Skiepko*

## **DECLARATION OF CONFORMITY EC 04/P/16**

Z.P.D. SKIEPKO  
Wiesław Skiepko  
ul. Kolejowa 33  
29-100 Włoszczowa

We hereby declare that the product manufactured by our company

Name: Pellet burner  
Series: ECO-BURNER  
Type/model: UNI-MAX O 100 – 1000 kW

Meets the requirements of the following standards and harmonized standards:

PN-EN 303-5:2012, EN 60335-2-102, EN 60730-1:2012  
EN 953:1997+A1:2009, PN-EN 60127-1:2008, PN-EN 60446:2008,  
PN-EN 60519-2:2008, PN-EN 60730-2-5:2006, PN-EN 15456:2008, PN-EN 230:2010

and meets the principal requirements of the following directives:

2006/42/WE

2006/95/WE LVD (including the revision)

2014/30/W/UE EMC (including the revision)



The product is provided with CE marking

Włoszczowa, April 27, 2016

  
Wiesław Skiepko  
Właściciel



## TERMS AND CONDITIONS OF THE GUARANTEE

1. Z.P.D. SKIEPKO, the Manufacturer, grant a guarantee for efficient operation of the burner for period of 24 months from the date of purchase and for the period not longer than 36 months from date of manufacture.
2. The Manufacturer provides a 12-month warranty on elements working in a fire.
3. Material defects and design errors shall be removed at the expense of the Manufacturer within 21 business days from the date of written notification of the complaint submitted to the Manufacturer and in the period not longer than 7 days from acceptance of the complaint.
4. The product used in relation to the conducted business activity by the End-customer is covered by the Manufacturer's 12-month guarantee.
5. The manner, scope and conditions of the device repair shall be specified by the Manufacturer.
6. Each information about the defects must be submitted to the Manufacturer in writing immediately after their discovery, on the attached complaint report. The compliant report is also available at the website [www.ecopalnik.pl](http://www.ecopalnik.pl).
7. The documents authorizing the purchaser to a free of charge guarantee repair are: filled-out Guarantee Card/Installation Report accepted by the purchaser and the document confirming the purchase of the burner (boiler including the burner).
8. The Guarantee Card is invalid if it does not have the required stamps, signatures and dates.
9. The Customer must send the filled-out Guarantee Card/Installation Report to the Manufacturer within 14 days from the date of commissioning of the device to register it in the guarantee service system to the following address: [biuro@eco-palnik.pl](mailto:biuro@eco-palnik.pl) or by mail.  
Otherwise, the Customer may assert its rights on the basis of commercial warranty.
10. The first start-up of the burner and setting of the operating parameters shall be the responsibility of the fitter (utility company holding the Manufacturer's authorization). This service may be subject to a fee.
11. The Manufacturer shall not be liable for any damage resulting from the operation or failure of the equipment and the costs of substitute heating.
12. **THE GUARANTEE IS NOT VALID** in the case of mechanical damage as a result of improper use or normal wear. The guarantee does not cover costs of the installation, transport and damage caused as a result of transport and, in particular, in the case of:
  - installation, start-up and operation which is not compliant with this operation manual and damage not attributable to the Manufacturer,
  - damage caused as a result of careless transport of the burner,
  - changes and modifications of the burner design without written consent of the Manufacturer,
  - burner start-up without installation in the boiler,
  - too small cross-section of the stack and the stack draft below 5 Pa,
  - performance of repairs in the guarantee period by unauthorized persons,
  - damage which may arise due to the electrical system faults,
  - damage due to improper transport, including transport to the boiler house,
  - wrong settings of the burner operating parameters, including burner operation above the nominal power of the device,
  - finding inadequate quality of fuel combustion resulting in formation of slag and tar on the burner which are difficult to remove and cause damage,
  - no possibility of repair due to reasons not attributable to the Manufacturer (e.g. no fuel, no access to the burner, no stack draft, etc.).
13. **THE GUARANTEE DOES NOT COVER:**
  - Operating parameters control,
  - Cleaning and maintenance,
  - Igniter replacement,
  - Spiro pipe.
14. Costs of requesting the Manufacturer's service to handle the complaints resulting from the reasons referred to in points 11 and 12 shall be borne by the Customer
15. Complaints should be submitted by: mail, fax or e-mail to the Manufacturer's address.





# 15 INSTALLATION REPORT

**Customer's details:**

phone.: e-mail:  
**Seller:** **Date of sell:**

phone.: e-mail:  
**Details of the company installing the burner:** **Date of first start-up:**

phone.: e-mail:  
**Details concerning installation:**  
 ECO-PALNIK Type: kW  
 Serial no.: Year of manufacture.:

Boiler: Year of manufacture.:  
 Power: kW

**Comments:**

**Data concerning the burner and combustion parameters:**

Measured 10-minute capacity of feeder: kg/10min. x6 kg/h

<b>Air setpoints:</b>		<b>Cleaning mechanism settings:</b>
% of rorarlional speed of the fan for MAX power.:	%	Mode of operation of the cleaning mechanism.: or Movable grate - mode:
% of rorarlional speed of the fan for MIN power.:	%	Cleaning mechanism work time.: lub Movable grate - work:
<b>Fuel setpoints:</b>		Cleaning mechanism retraction time.:
Fuel amount for MAX power.:	%	Cleaning mechanism pause time.: lub Movable grate - pause:
Fuel amount for MAX power.:	%	Opening time cleaning mechanism.: lub Movable grate - opening.:
<b>Flame detector type:</b>		Closing time cleaning mechanism.:
Igniter deactivation for the photocell value:		

**Results of the flue gas analysis:**

<b>Flue gas temperature [°C]:</b>	Max power:	Min power:
<b>CO emission [ppm]:</b>	Min power:	Min power:
<b>Stack draft [Pa]:</b>		
<b>Excess air coefficient <math>\lambda</math> or oxygen %:</b>	Max power:	Min power:
<b>Efficiency [%]:</b>	Max power:	Min power:

I confirm with my signature that I have been trained in the operation, basic adjustment and cleaning of the above-mentioned burner and boiler.

\_\_\_\_\_  
 Legible signature of the Customer

\_\_\_\_\_  
 Legible signature of the Fitter

The terms and conditions of the guarantee have been described in detail in this OMM. In the case of problems with operation of the burner, please contact the utility performing the first start-up.

## 16 Composition of the set

Component name	I hereby confirm the completeness of	Notes
Pellet burner		
Ø70 strain relief		
Control together including sensors		
Feeder		
Ø70 Spiro pipe		
Burner cover		
The composition of the set is compliant with the actual status:		
..... Signature of the Customer		..... Signature of the Fitter





Z.P.D. SKIEPKO Wiesław Skiepko, 29-100 Włoszczowa  
phone +48 41 39 45 518, +48 533 101 691, +48 503 860 816  
[serwis@eco-palnik.pl](mailto:serwis@eco-palnik.pl), [marketing@eco-palnik.pl](mailto:marketing@eco-palnik.pl),  
[techniczne@eco-palnik.pl](mailto:techniczne@eco-palnik.pl), [biuro@eco-palnik.pl](mailto:biuro@eco-palnik.pl),  
[zamowienia@eco-palnik.pl](mailto:zamowienia@eco-palnik.pl),  
[www.eco-palnik.pl](http://www.eco-palnik.pl).