

Dear Customer,

We thank you for having chosen one of our products, the fruit of technological experience and of continual research for a superior quality product in terms of safety, dependability, and service. In this manual you will find all the information and useful suggestions to use your product with the maximum safety and efficiency.



We highly recommend to turn to our Authorized Service Centre for the installation and the first ignition of the device as it not only carries out the installation perfectly but also verifies the regular operation of it.

- Incorrect installation, incorrectly performed maintenance, improper use of the product release the manufacturer from every eventual damage derived from the use of the stove.
- The unit cannot be used as an incinerator. Do not use fuels other than pellets.
- This manual has been realized by the manufacturer and constitutes an integral part of the product and must remain with it during its entire lifetime. If the product is sold or transferred, be sure that the booklet is present since the information contained in it are addressed to the buyer, and to all those persons of various titles who complete the installation, use and maintenance.
- Carefully read the instructions and the technical information contained in this manual, before proceeding with the installation, use, and any operation on the product.
- The observance of the indications contained in the present manual guarantees the safety of people and the product, the economy of use and a longer functioning lifetime.
- Although the carefully studied design and the risk analysis done by our company has permitted the realization of a safe product, in any case, before effecting any operation on the stove, it is recommended to keep said manual available and pay scrupulous attention to the instructions written therein.
- Be very careful when moving the ceramic details where present.
- Check the precise flatness of the pavement where the product will be installed
- The wall where the product will be placed must not be constructed in wood, or in any case, made of an inflammable material, and in addition it is necessary to maintain a safety distance.
- While the stove is in operation, several parts of the stove (door, handle, sides) can reach high temperatures. Therefore pay attention and use the proper precautions, above all in the presence of children, elderly or disabled persons, and animals.
- Assembly must be performed by authorized persons (Authorized Assistance Center).
- Diagrams and drawings are furnished for the purpose of illustration; the manufacturer, with the intent of pursuing a policy of constant development and renewal of the product can, without any notice, make any modifications that are believed opportune.
- When the stove is working at its maximum speed, it is strongly suggested to wear gloves while handling with the door for pellets loading and the door handle.
- It is prohibited to install in bedrooms or in explosive environments.
- Only use replacement parts recommended by the supplier.



Never cover the body of the stove in any way or obstruct the openings placed on the upper side when the device is operating. All our stoves are trial lighted on the construction line.

In the event of a fire, disconnect the power supply, use an extinguisher and call the fire fighters if necessary. After that contact the Authorized Assistance Center.

This instruction booklet is an integral part of the product: make sure that it always accompanies the appliance, even in case of transfer to another owner or in the case of transfer to another place. In the event of damage or loss, request a copy from the area technician.

These symbols indicate specific messages in this booklet:



ATTENTION:

This warning sign indicates that the message to which it refers should be carefully read and understood, **because failure to comply with what these notices say can cause serious damage to the stove and put the user's safety at risk.**



INFORMATION:

This symbol is used to highlight information which is important for proper stove operation. Failure to comply with these provision will compromise use of the stove and its operation will not be satisfactory.

Norms and declarations of conformity

Our company declares that the stove conforms to the following norms for the EC European Directive labelling:

- 2014/30 UE (regulation EMCD) and following amendments;
- 2014/35 UE (Low Voltage Directive) and following amendments;
- 2011/65 EU (RoHS 2 directive);
- The Rules of Construction Products (CPR-Construction Products Regulation) No. 305/2011 regarding the construction world;
- For installations in Italy, please refer to UNI 10683/98 or following changes. **While installing the unit respect the local, national and European rules;**
- EN 55014-1; EN 55014-2; EN 61000-3-2; EN 61000-3-3; EN 60335-1; EN 60335-2-102; EN 62233, EN 50581.

Safety information

Please carefully read this use and maintenance manual before installing and operating the stove! If clarification is needed, please contact the dealer or the Authorized Assistance Center.

- The pellet stove must only be operated in living environments. This stove, being controlled by an electronic board, permits a completely automatic and controlled combustion; the exchange, in fact, regulates the lighting phase, 5 power levels and the shut down stage, guaranteeing the safe operation of the stove.
- The basket used for combustion allows most of the ash produced by the combustion of the pellets to fall into the collection compartment. Nevertheless, check the basket daily, given that not all pellets have high quality standards (use only quality pellets recommended by the manufacturer).

Responsibility

With the delivery of the present manual, we decline all responsibility, both civil and penal, for accidents deriving from the partial or total lack of observance of the instructions contained herein.

We decline every responsibility derived from improper use of the stove, from incorrect use by the user, from unauthorized modifications and/or repairs, from the use of replacement parts that are not original for this model. The manufacturer declines every civil or penal, direct or indirect responsibility due to:

- Lack of maintenance;

- Failure to observe the instructions contained in the manual;
- Use in non-conformity with the safety directives;
- Installation in non-conformity with the norms in force in the country;
- Installation by unqualified or untrained personnel;
- Modifications and repairs not authorized by the manufacturer;
- Use of non-original replacement parts;
- Exceptional events.



- **Use only wood pellets;**
- **Keep / store the pellets in a cool dry place;**
- **Never pour pellets directly on the hearth;**
- **The stove must only be fed with quality 6 mm diameter pellets, A1 certified according to the UNI EN ISO 17225-2 regulations;**
- **Before making the electrical connection of the stove the discharge tubes must be connected with the flue;**
- **The protective grill placed inside the pellet container must never be removed;**
- **The environment where the stove is installed must have a sufficient exchange of air;**
- **It is forbidden to operate the stove with the door open or the glass broken;**
- **Do not use the stove as an incinerator; the stove should be used only for the intended purpose;**
- **Any other use is considered improper and therefore dangerous. Do not put in the hopper other than wood pellets;**
- **When the stove is operating, the surfaces, glass, handle and tubes become very hot: during operation do not touch these parts without adequate protection;**
- **Keep the fuel and other inflammable materials off the stove.**

Charge pellet

Fuel is loaded from the upper part of the stove by opening a door.

Pour the pellets in the hopper. This is easier if performed in two steps:

- Pour half of the contents of the bag into the hopper and wait for the fuel to settle on the bottom.
- Then pour in the second half;
- Keep the cover closed, after loading the pellets, the lid of the fuel tank;
- Before closing the door load-pellet make sure that there are no residues of pellets around the seal. If carefully cleaned to avoid compromising the seals.

The stove is a product by heating, presents the external surfaces particularly hot.

For this reason, we recommend extreme caution when operating in particular:

- Do not touch the stove body and the various components, do not approach the door, it could cause burns;
- Do not touch the exhaust fumes;

- Do not perform any type of cleaning;
- Do not dump the ashes;
- Do not open the ash tray;
- Be careful that children do not come near;



Never remove the protection grille in the hopper. When filling, do not let the sack of pellets touch any hot surfaces.

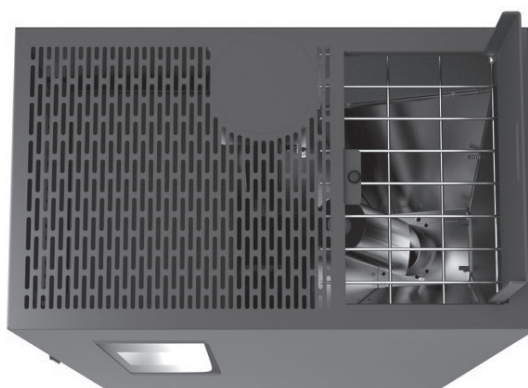

Instructions for safe and efficient use

- The device can be used by children that are not less than 8 years old and people with reduced physical, sensory or mental capabilities, or lack of experience or knowledge, provided being under supervision of someone responsible or after having received instructions relating to the safe use of the device and to the understanding of the dangers inherent to it. Children should not play with the device. Cleaning and maintenance to be performed by the user should not be made by children without supervision;
- Do not use the stove as a ladder or scaffold;
- Do not put clothes to dry on the stove; Any clothes hangers and suchlike must be kept a suitable distance from the stove. - Risk of fire;
- Carefully explain that the stove is made from material subjected to high temperatures for the elderly, the disabled, and in particular for all children, keeping them away from the stove during operation;
- Do not touch the stove with wet hands: the stove has electrical components that could produce sparks if handled incorrectly;
- Never open the glass door of the pellet stove while the stove is in operation;
- The stove must be connected to an electrical system equipped with an earthing conductor in accordance with regulations 73/23 and 93/98 EEC;

- The system must be of adequate electrical power declared the stove;
- Do not wash the inside of the stove with water. The water could damage the electrical insulation, causing electric shock;
- Do not expose your body to hot air for a long time. Do not overheat the room you are in and where the stove is installed. This can damage the physical conditions and cause health problems;
- Do not expose to direct the flow of hot air plants or animals;
- The pellet stove is not a cooking element;
- External surfaces during operation can become very hot. Do not touch them except with the appropriate protection;
- The plug of the device power cable must be connected only after installation and assembly of the device and must remain accessible after installation, if the unit is not provided of a double-pole switch suitable and accessible.
- Pay attention that the power cord (and any other cables external to the appliance) do not touch hot parts.
- Do not lay objects, glasses, infusers, room perfumers on the stove, they could be damaged or to damage the stove (in this case de warranty does not respond).

Operating area

For proper functioning and a good temperature distribution, the stove should be positioned in a location where it is able to take in the air necessary for combustion of the pellet (about 40 m³/h must be available), as laid down in the standard governing the installation and in accordance with local national standards.

The volume of the room must not be less than 30 m³.

The air must come in through permanent openings made in walls (in proximity to the stove) which give onto the outside, with a minimum cross-section area of 100 cm².

These openings must be made in such a way that it is not possible for them to be obstructed in any way. Alternatively, the air can be taken from rooms adjacent to the one which needs ventilating, as long as they are provided with an air intake from the outside, and are not used as bedrooms or bathrooms, and provided there is no fire risk such as there is for example in garages, woodsheds, and storerooms, with particular reference to what is laid down in current standards.

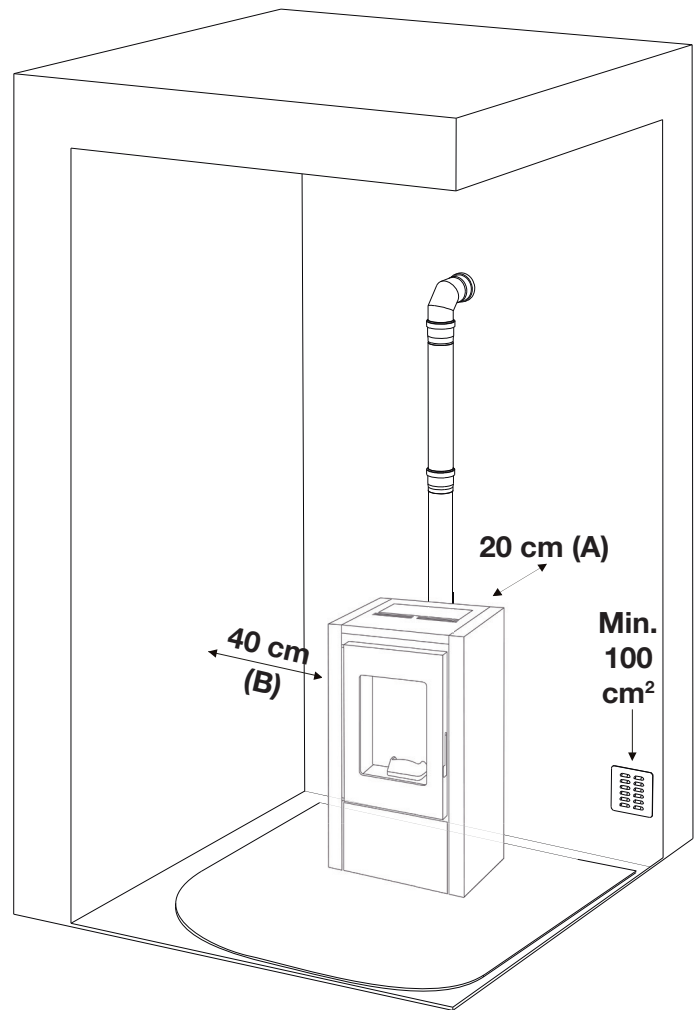

It is not permissible to install the stove in bedrooms, bathrooms, or in a room where another heating appliance is installed (fireplace, stove etc.) which does not have its own independent air intake. Locating the stove in a room with an explosive atmosphere is prohibited.

The floor of the room where the stove is to be installed must be strong enough to take its weight. If walls are flammable, maintain a minimum distance of 20 cm at the rear (A), of 40 cm at the side (B) and 100 cm at the front. If the room contains objects which are believed to be particularly delicate, such as drapes, sofas and other furniture, their distance from the stove should be considerably increased.



In the presence of wood floors, install a floor protection surface in compliance with the rules in force in the country

Connection to the external air intake

It is essential that at least as much air must be able to flow into the room where the stove is installed as is required for proper combustion in the appliance and for the ventilation of the room.

This can be effected by means of permanent openings in the walls of the room to be ventilated, which give onto the outside, or by single or collective ventilation ducts.

For this purpose, on the external wall near the stove, a hole must be made with a minimum free cross-section of 100 cm². (equivalent to a round hole of 12 cm diameter or a square hole 10x10 cm) protected by a grille on the inside and the outside. The air intake must also:

- communicate directly with the room where the stove is installed
- be protected by a grille, metal mesh or suitable guard, as long as this does not reduce the area below the minimum
- be positioned in such a way as to be impossible to obstruct.

Back flue pipe connection

The default stove is supplied already equipped with the back flue outlet. In this case it is necessary first to assembly the 80mm flue pipe connection, placed into the tank, with high temperature silicone on the back fumes box. (Pic.1)



Pic. 1

Upper flue pipe connection

As the default stove is equipped with the back flue outlet, it is necessary to remove the aesthetic covering by unscrewing the screws (Pic. 2) and lifting it upwards (Pic. 3).

Then break the covering pre-cut. remove the flange and the seal pre-installed at the flue pipe exit (Pic. 4).

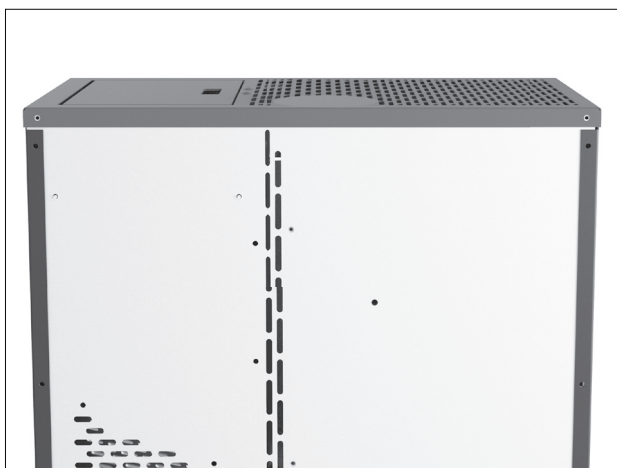

Pic. 2

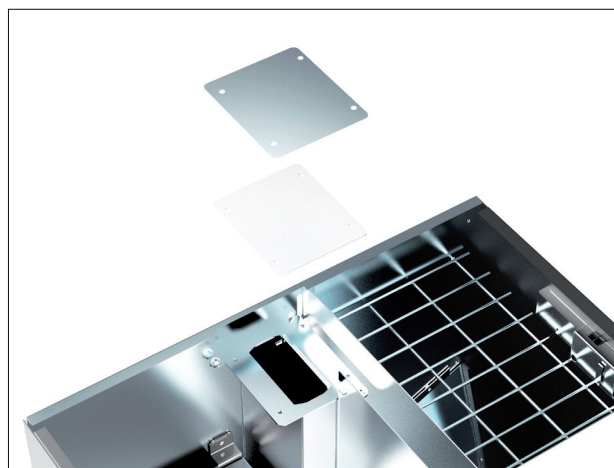

Pic. 4



Pic. 3

Place the flange and the seal on the back fumes box (Pic. 5-6). This flange can be used as inspection compartment.



Pic. 5



Pic. 6

Take the 80mm diameter flue connection (placed into the tank) and install it with high temperature silicone in the specific connection (Pic. 7-8).



Pic. 7



Pic. 8

Follow the instructions in the next chapters for the flue pipe connection, bearing in mind that in case of upward flue outlet it is not necessary to install the T-fitting.

In order to achieve the test report results, please load the performance parameters retained by the manufacturer and the qualified technician. They will use these parameters once verified that, during the installation, it is possible to reproduce the laboratory conditions.

Connection to the flue pipe

The flue pipe must have internal dimensions not larger than 20x20 cm, or diameter 20 cm. In the event of larger dimensions, or of the flue pipe being in poor condition (for example cracks, poor insulation, etc.), it is advisable to fit a stainless steel pipe of suitable diameter inside the flue pipe throughout its length, right up to the top. Check with suitable instruments that there is a draught between 3 Pa and 10 Pa. This type of connection ensures the evacuation of the fumes even in the event of a temporary power cut. At the bottom of the flue pipe, provide an inspection cap to allow periodic checking and cleaning, which must be done annually. Make a gas-tight connection to the flue pipe, using pipes and connectors as recommended by us. You must ensure that a windproof cowl should be fitted which complies with the standards in force.

Connection to an external flue with insulated or double-wall pipe

The only type of pipe which is permissible is insulated (double-walled) stainless steel, smooth on the inside, fixed to the wall. Flexible stainless steel pipe must not be used. At the bottom of the flue pipe, provide an inspection cap to allow periodic checking and cleaning, which must be done annually. Make a gas-tight connection to the flue pipe, using pipes and connectors as recommended by us. You must ensure that a windproof cowl should be fitted which complies with the standards in force. Check with suitable instruments that there is a draught between 3 Pa and 10 Pa.

Connection to the flue pipe

For proper functioning, the connecting pipe between the stove and the chimney or flue duct must have a slope of not less than 3% in the horizontal stretches, the length of which must not exceed 2 metres and the vertical distance between one tee connector and another (change of direction) must not be less than 1,5 m. Check with suitable instruments that there is a draught between 3 Pa and 10 Pa. At the bottom of the flue pipe, provide an inspection cap to allow periodic checking and cleaning, which must be done annually. Make a gas-tight connection to the flue pipe, using pipes and connectors as recommended by us. You must ensure that a windproof cowl should be fitted which complies with the standards in force.

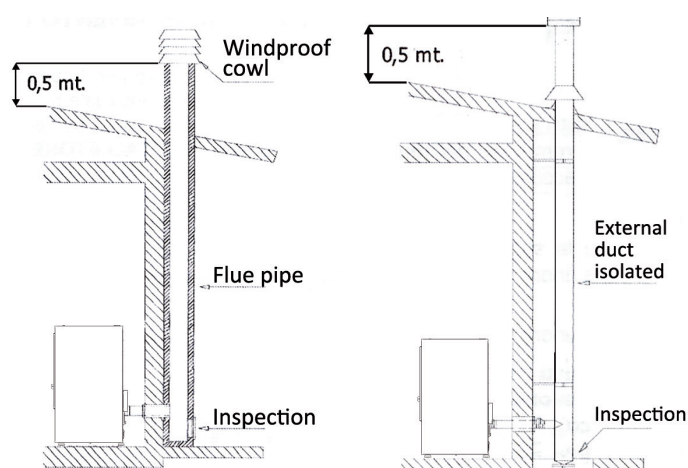
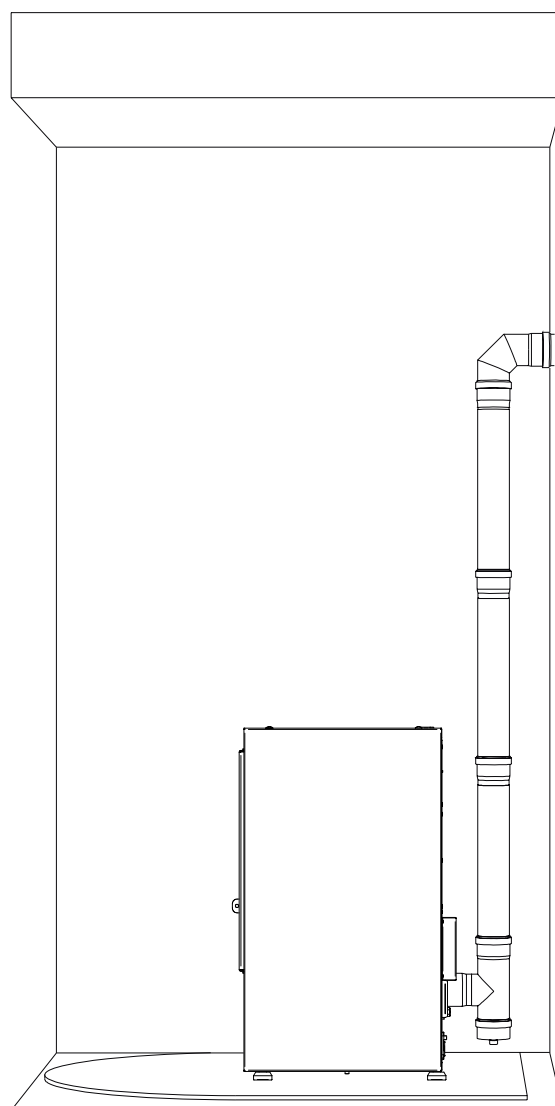

Fig. 2: connection to the flue pipe.

Fig. 3: connection to an external flue with insulated or double-wall pipe.

Fireplace flue gas

Avoid contact with combustible materials (example: wooden beams) and in any case provide for their insulation with flame retardant material. In case of pipe penetrations through roofs or walls is recommended to use special kits crossing, certificates, are available commercially. In the event of a chimney fire, turn off the stove, disconnect from the network and never open the door. Then call the authorities.

The chimney cap

The chimney cap must respect the following requirements:

- It must have the equivalent diameter and internal form of the flue.
- It must have a useful outlet diameter of not less than double that of the flue.
- The chimney cap on the roof or that remains in contact with the outside (for example, in case of open lofts or attics), must be covered with elements in brick or tile and must, in any case, be well insulated.
- It must be constructed to prevent rain, snow, and extraneous bodies from entering the flue and so that the discharge of the products of combustion is not inhibited by wind from any quarter or strength (wind-proof chimney cap).
- The chimney cap must be positioned in such a way as to guarantee the adequate dispersion and dilution of the products of combustion and in any case, must be out of the reflux zone. This zone has different dimensions and forms according to the angle of inclination of the roof so it is necessary to adopt minimum heights.
- The chimney cap must be a wind-proof type and must be above the ridge.
- Eventual structures or other obstacles that are higher than the chimney cap must not be too close

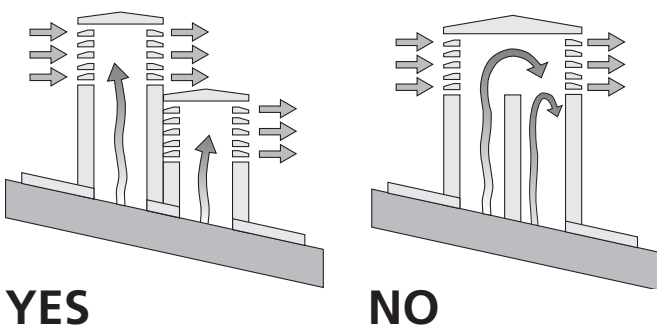

Fig. 5: characteristics of chimney

to the chimney cap itself.

- The device should not be installed in the flue shared.

Distance to objects

It is also recommended to keep the pellets and all flammable materials at a suitable distance from the stove.

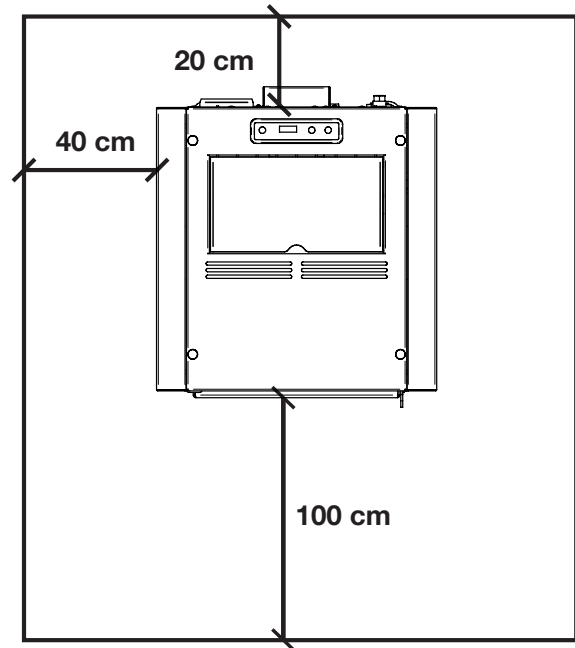

REMARKS:

- the appliance must be installed by a qualified technician in possession of the technical and professional requirements according to the DM37/2008 that, under its responsibility, to ensure compliance with the rules of good technique.
- you need to keep in mind all laws and national, regional, provincial and municipal laws of the country in which you installed the device
- check that the floor is not flammable: if necessary use a suitable platform
- in the room where the generator must be installed to heat must not pre-exist or be installed with an extractor hood or ventilation ducts of the collective type.
- Should these devices be located in adjacent rooms communicating with the installation, and 'prohibited the simultaneous use of the heat generator, where there is a risk that one of the two rooms being placed in depression than the other
- it is not permissible to install in bedrooms or bathrooms.

Stove start up



Remove any components which might burn from the firebox and from the glass (various instructions and adhesive labels).

Charge pellet

Fuel is loaded from the upper part of the thermostove by opening a door. Pour the pellets in the hopper. This is easier if performed in two steps:

- Pour half of the contents of the bag into the hopper and wait for the fuel to settle on the bottom.
- Then pour in the rest.



Never remove the protection grille in the hopper. When filling, do not let the sack of pellets touch any hot surfaces.



The brazier should be cleaned before each starting.

First lighting of the stove

- Before switching on, make sure that the grate is clean and empty of any pellet residues from previous combustions. Otherwise make sure you empty and clean it
- Fill the container 3/4 full with the pellets recommended by the manufacturer
- Connect the stove to an electrical outlet with the cable that has been supplied
- Press the lighting switch located on the back part of the stove
- The upper display will read **"OFF"**
- Press the button  for 2 seconds. After a few moments the smoke extractor and the lighting resistor will start and the display will read **"FAN ACC"**; The led resistance is switched on
- After 1 minute the display will read **"LOAD PELLETT"**, the stove will load the pellets and continue lighting the resistor
- Once the appropriate temperature has been reached the display will read **"FIRE ON"**: this means that the stove has begun the last phase in lighting, at the end of which the stove will be completely operational; The led resistance is switched off
- After some minutes the display will show the words **"ON 1-2-3-4-5"** alternating room temperature and current working power. The stove is now completely on
- When the stove reaches the set temperature, the display will show **"ECO"**.
- The temperature LED lights up when the set temperature is reached.



Before lighting a small amount of smoke may fill the combustion chamber.



We highly recommend to turn to our Authorized Service Centre for the installation and the first ignition of the device as it not only carries out the installation perfectly but also verifies the regular operation of it. During the first lighting the environment should be well ventilated since during the first hours of operation unpleasant odours could develop due to the physical stabilizing of the paint and from the grease in the tube bundle.

Stove switching off

To switch off the stove, press the key \odot on the control board until you read **"OFF"** on the display. After the stove has been switched off, the fan continues working for a set time in order to grant a fast smokes exhaust from the combustion chamber.

If you have a model with remote control, you just need to switch the remote control off keeping the key pressed for 2 seconds and confirming the selection pressing the key SEND.

If you try to switch on the stove during this phase, the display will show **"ATTE"** (that means wait for cooling) in order to inform you a switching off phase is running. Wait until the cooling phase is completely off and the display shows **"OFF"** before starting a new light up.

REMARKS:

- Do not continuously turn the stove on and off as this could provoke sparks that could shorten the life of the electrical components;
- Do not touch the stove with wet hands: the stove has electrical components that could produce sparks if handled incorrectly. Only authorized technicians can resolve possible problems;
- Do not remove any screws from the fire chamber without first lubricating them well;
- Never open the glass door of the pellet stove while the stove is in operation;
- Be sure that the brazier basket is positioned correctly;
- The flue system must be suitable for inspection. If it cannot be removed, it must have some holes for inspection and cleaning;

Function keys

1. Temperature or power decrease
2. Temperature or power increase
3. Key On/Off
4. Receiver
5. Led alarm ALC
6. Led alarm ALF
7. Led chrono-thermostat
8. Led temperature ok
9. Led pellets loading
10. Led resistance
11. Display LED 7 segments
12. Led On/Off

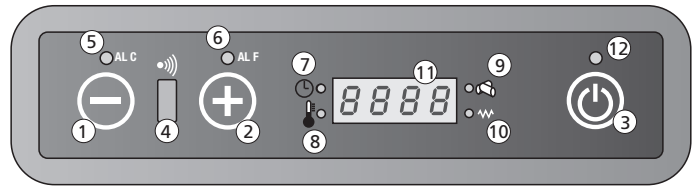

1. Temperature or power decrease

Using the key on the menu Set temperature, you can decrease the temperature from a maximum value of 40 °C to a minimum value of 7 °C.

With the key on the menu Set power, you can decrease the working power from a maximum value of 5 to a minimum value of 1.

2. Temperature or power increase

ing the key on the menu Set temperature, you can increase the temperature from a min. value of 7°C to a max. value of 40°C.

With the key on the menu Set power, you can increase the working power from a min. value of 1 to a max. value of 5.

3. Key On/Off

Keep the key pressed for 2 seconds to switch the stove on or off.

4. Receiver

Sensor receiving the settings of the remote control.

5. Led alarm ALC

The led blinks in the event of a malfunction or alarm.

6. Led alarm ALF

The led blinks in the event of a malfunction or alarm.

7. Led chrono-thermostat

This means the automatic single or daily programming of the switching on or off of the stove is on.

The automatic programming can be set only with the remote control (optional).

8. Led temperature ok

This is on when the stove reaches the set temperature. In this case you will read the word "Eco" and the set temperature on the display.

9. Led pellets loading

This led blinks every time the stove is loading pellets.

10. Led resistance

This led is on only while the stove is lighting up in order to indicate that the resistance is warming the air which will fire the pellets.

11. Display LED 7 segments

On the display you can read the different working functions of the stove, the room temperature and the set working power. In the event of a malfunction, the display shows the relative error codes (see paragraph on alarm codes).

12. Led On/Off

This led indicates the different phases of the stove:

- it is on if the stove is switched on and working
- it is off if the stove is switched off
- it blinks if the stove is switching off

Stove setting

How to change the wished room temperature

Join the following procedure to change the wished temperature: press the key \ominus (1) once to enter the menu and set temperature. You will read the word "Set" and the wished temperature on the display. Use the keys \ominus (2) and \oplus (3) to increase or reduce the wished value. The stove will leave the menu Set temperature automatically as soon as you do not work on it for some seconds.

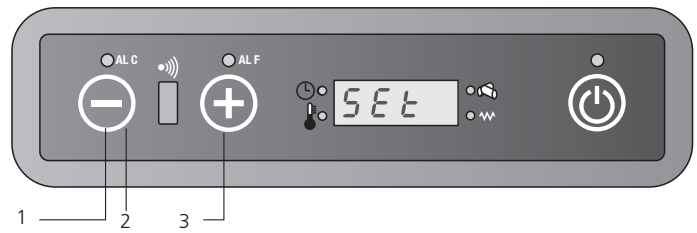

How to change the working power

Join the following procedure to change the working power: press the key \oplus (1) once to enter the menu and set the working power. You will read the word "Pot" and the range of 5 possible powers on the display. Use the keys \ominus (2) and \oplus (3) to increase or reduce the wished value. The stove will leave the menu Set working power automatically as soon as you do not use it for some seconds.

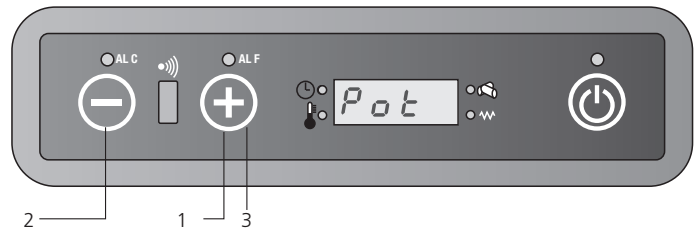

Remote control (if any)

Keys and main functions

The remote control can be used to check the stove. The remote control offers some functions which are not available from the keyset, like the automatic programming of the switching on and off of the unit.

How to use the remote control:

1. Direct the remote control on the control board of the stove
2. Check there are no obstacles between the remote control and the receiver on the stove
3. Every function you set on the remote control must be confirmed pressing the key SEND.

After selecting the wished function, an acoustic signal will confirm your choice.



On/Off







This function is used to switch the stove and the remote control on or off. Keep the key pressed for at least two seconds to switch the system on or off. Then press the key SEND.



You can use the two keys to set the wished temperature between a min. value of 7°C and a max. value of 40°C.



Please join the following procedure to set the functioning mode:

-  Automatic Functioning
-  power 1(on1)
-  power 2 (on2)
-  power 3 (on3)
-  power 4 (on4)
-  power 5(on5)



SEND

Use this key to transmit the selected information to the pcb.



ECONO





This key activates or deactivates the function ECONO. Keep the key pressed for at least two seconds to activate or deactivate this function.

**TURBO**

This key activates or deactivates the function TURBO. Keep the key pressed for at least two seconds to activate or deactivate this function.

**CLOCK FUNCTION**

Please join the following procedure to set the clock function on the remote control:

- press the symbol  and the time blinking.
- use the keys  and  to set hour and minutes.
- press  again to confirm and SEND to transmit the function to the pcb.

**ON1**

Using this key you can set a single time schedule for the automatic switching on of the stove (program 1).

**OFF1**

Using this key you can set a single time schedule for the automatic switching off of the stove (program 1).

**ON2**

Using this key you can set a single time schedule for the automatic switching on of the stove (program 2).

**OFF2**

Using this key you can set a single time schedule for the automatic switching off of the stove (program 2).

**AUTO**

With this key you can decide to repeat the programmed switching on and off (program 1 and 2) every day. The key AUTO activates this function.

Keep the key pressed for at least two seconds to activate or deactivate this function.

**CANCEL**

Use the key CANCEL in the event you want to cancel some programmed switching on or off of the stove.

**Lock / Unlock button**

Press and hold the key for at least 2 seconds to activate / deactivate this function.

(Not available on LCD 2)

**SLEEP**

This function allows, after an hour from sending the command, to automatically lower the temperature set by 1° C. (Not available on LCD 2)

Change the temperature

You can change the temperature using the keys  (1) and  (2). The temperature range goes from a min. value of 7°C to a max. value of 40°C.

Once you have chosen the wished temperature, confirm your selection pressing the key  (3).

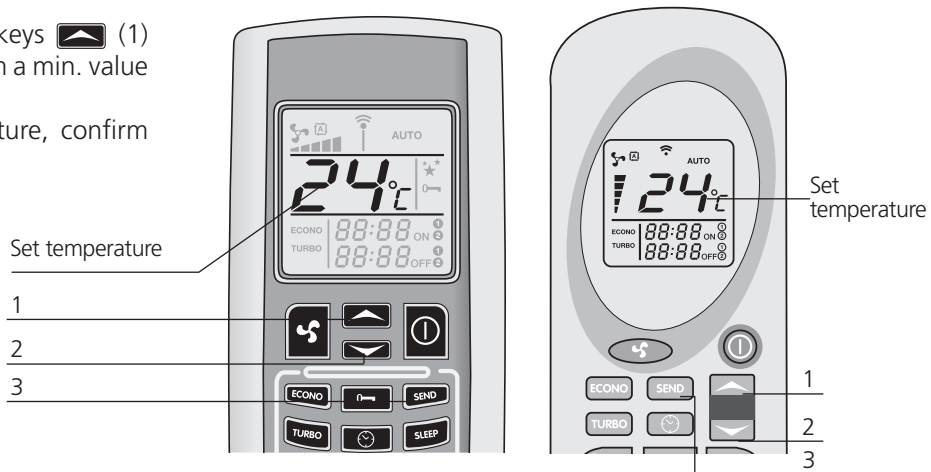



Change the power

Use the key  (1) to select the power of the stove. The marks (2) on the display of the remote control indicate the five possible powers. Press the key SEND (3) to confirm your selection. You will see the words on1-on2-on3-on4-on5 and the room temperature on the control board of the stove according to the selected power.

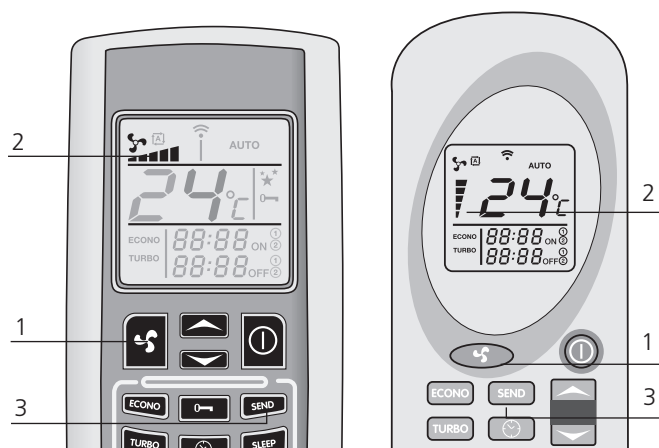
You can also select the automatic function. Please refer to the paragraph on the Automatic Power Function to understand how the stove works in this mode.



Automatic power function

To enter this function, press the key  (1), until you see the symbol  on the display. Press SEND (2) to transmit your selection. You will read the word "Auto" and the room temperature on the control board of the stove.

When you select this mode, the pcb will set the working power automatically according to the difference in degrees between the set temperature and the temperature identified by the sensor on the back of the stove.

Press , once more, select the wished power and press SEND to go back to the usual functioning.

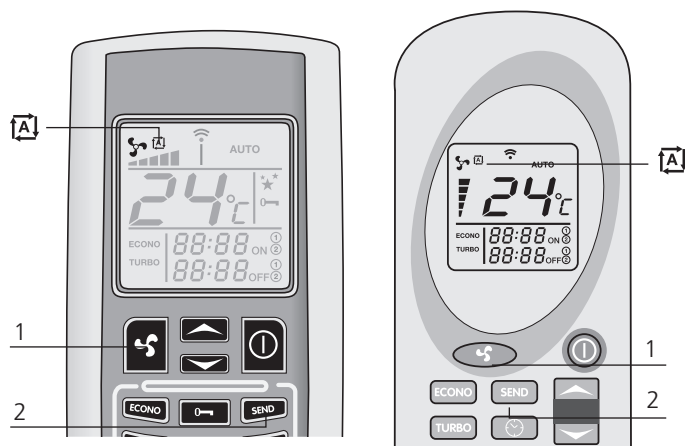

Function TURBO

This function has been developed in the event you need to heat your room quickly, for example when you have just switched the stove on. When you choose this function, the stove will work at its max. power for a period of thirty minutes and the temperature will be automatically set at 30°C. After thirty minutes (or earlier if you give different selections from the remote control), the stove will restart working as it did before you activated the turbo function. Keep the key TURBO (1) pressed for at least two seconds to activate this function. You will read the word "TURBO" (2) on the display of the remote control. Set temperature and working power will disappear. Press SEND (3) to transmit the selection to the pcb.

You will read the word "Turb" on the control board on the upper part of the stove. This word will appear together with the room temperature and working power set before activating the function TURBO.

If you want to deactivate this function before thirty minutes have passed, press the key TURBO (1) once again for at least two seconds. The word TURBO on the display of the remote control will disappear and you will see the set temperature and power again. Press the key SEND (3) to confirm your selection.

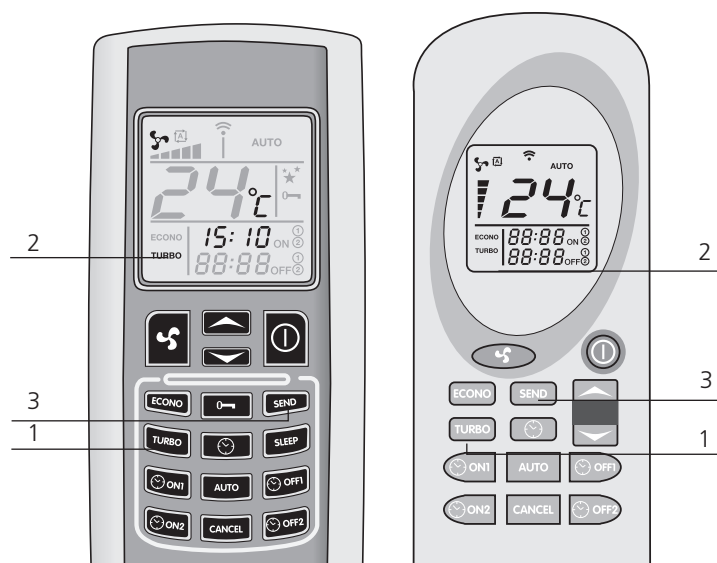

Function ECONO

The function ECONO has been developed to save money and it is used when you want to keep the temperature constant in the room. This function lets the stove decrease its working power every 10 minutes until it reaches the power 1.

Keep the key ECONO (1) pressed for at least two seconds to activate this function. You will read the word "ECONO" (2) on the display of the remote control. Set temperature and working power will disappear. Press SEND (3) to transmit the selection to the pcb.

You will read the word "Econ" on the control board on the upper part of the stove. This word will appear together with the room temperature and working power set before activating the function ECONO.

If you want to return to the standard function, press the key ECONO (1) once again for at least two seconds. The word ECONO on the display of the remote control will disappear and you will see the set temperature and power again. Press the key SEND (3) to confirm your selection.











- The time of the automatic switching on and off must be set when the remote control is Off;
- In the event of an even very short lack of current, you will miss the set time for the automatic switching on or off. Once the power supply is back, please program the stove again using the remote control;
- The stove switching on at the scheduled time will keep the same temperature and power you set before you last switched it off;
- Please consider an interval of min. 20 minutes between the switching off and subsequent switching on of the stove. In this way the unit will have time to arrange a complete cooling phase; in the event this minimal interval is not calculated, the stove will not switch on as scheduled.

Program 1 (ON1 and OFF1) Automatic switching on ON1

Please join the following procedure to set the time for the automatic switching on according to the program 1:



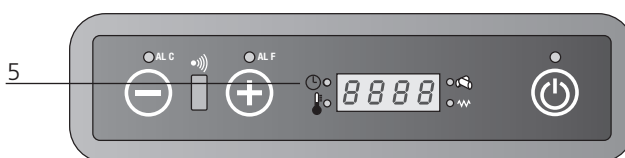
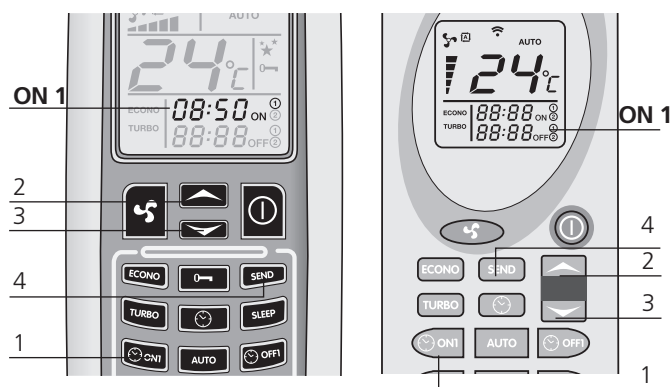

Press the key  (1). You will see the hours and minutes and the symbol ON1 blinking on the remote control. Use the keys  (2) and  (3) to change the wished time (intervals of 10 minutes). To scroll the time faster, keep the keys  (2) and  (3) pressed.

Confirm your selection pressing the key  (1) once again. You will now read the set switching on time on the remote control. Press SEND (4) to transmit your selection to the pcb of the stove.

The LED chrono-thermostat will light up on the control board indicating that the programming is on (5).



Automatic switching off OFF1

Press the key  (1). You will see the hours and minutes and the symbol OFF1 blinking on the remote control. Use the keys  (2) and  (3) to change the wished time (intervals of 10 minutes). To scroll the time faster, keep the keys  (2) and  (3) pressed.

Confirm your selection pressing the key  (1) once again. You will now read the set switching off time on the remote control. Press SEND (4) to transmit your selection to the pcb of the stove.

The LED chrono-thermostat will light up on the control board indicating that the programming is on (5).

The LED chrono-thermostat switches off as soon as the automatic switching on and off are completed.

The remote control does not show the previously set time schedule anymore.



Program 2 (ON2 and OFF2)

As above but with the keys ON2 and OFF2

Cancel any eventual already set timetables.

Please join the following procedure to cancel any other already set timetables. This example refers to the automatic switching off of the program 1 (Off1). The procedure is the same for all plans.

Press the key corresponding to the switching on or off time you want to cancel.

Referring to the example: press the key  (1).

You will see the hours and minutes and the symbol OFF1 blinking on the display of the remote control. Now press the key "CANCEL" (2) to cancel the automatic switching on or off timetables from the display.

Press the key SEND (3) to confirm your selection and transmit it to the pcb of the stove.



Daily repeat AUTO

Using the function AUTO, you can repeat the single automatic switching on and off you selected every day.

You just need to press the key AUTO (1) for at least two seconds to activate the function. You will read the words AUTO (2) on the display of the remote control. Press SEND (3) to confirm your selection and transmit it to the pcb of the stove. The LED chrono-thermostat will light up on the control board indicating that the programming is on.

You can deactivate the automatic repeat whenever you want just pressing the key AUTO again for at least two seconds. The words AUTO will disappear from the display. Press SEND (3) to confirm your selection and transmit it to the pcb of the stove.

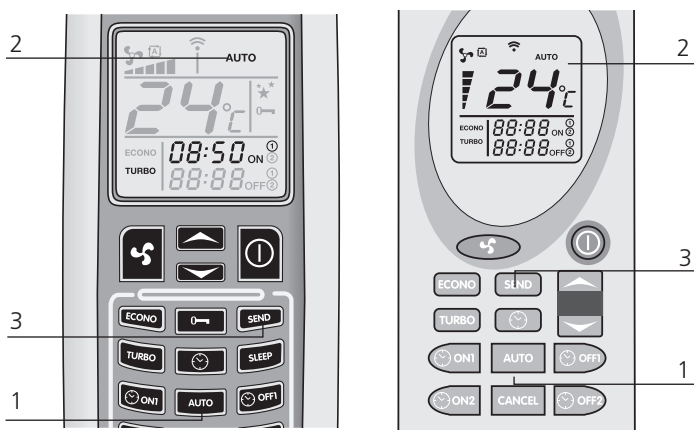

Function SLEEP (not available on LCD2)

The mode SLEEP is another function developed to save money. One hour after its activation, the system starts decreasing the set temperature automatically by 1°C.

Press the key SLEEP (1) on the remote control to activate the function SLEEP. You will see the symbol  on the display of the remote control. Press the key SEND (2) to transmit your selection to the stove.

The control board will register the new setting showing the word "SLEE" and the working power of the stove.

You can deactivate the function SLEEP whenever you want just pressing the key SLEEP again and the key SEND to confirm your selection.

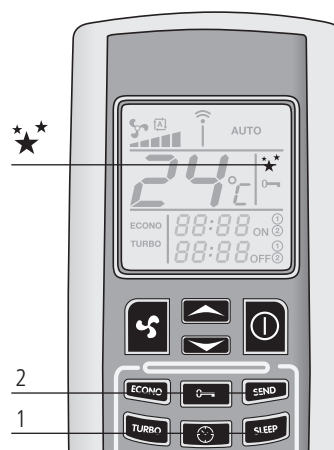

Please note: if the stove is working in "Auto", it is not possible to activate the function sleep.



Always clean the brazier before starting an automatic switching on in order to avoid any possible missed starts up which would damage your stove and the environment.

Alarms signal

In the event of a working defect, the system informs the user about the type of failure occurred. The following table summarises the alarms, kind of problem and possible solution:

No acc

This alarm occurs when the time foreseen for a light up (around 15 minutes) passes and the smokes temperature is still too low. This can occur also when there is not enough pellets flow to light up the unit. Press the key On/Off on the control board to reset the alarm. Wait until the cooling phase is completed, clean the brazier and start up with a new switching on.

No fire

This alarm occurs in the event the stove switches off during its working phase (for example if there is no pellets left in the pellets tank). You will read the words "Alarm No fire" on the display. Press the key On/Off on the control board to reset the alarm. Wait until the cooling phase is completed, clean the brazier and start up with a new switching on.

Cool fire

In the event of an even very short lack of current, the stove switches off. As soon as the power supply is back, the stove will start a cooling cycle and the display will show the words "Cool fire". After completing the cooling cycle, the stove will start up again.

NOTE: If your stove is supplied with a remote control and there is a lack of current, remember to program the eventual switching on and off times again. In the event of a lack of current, the stove will loose any previous time settings.

Once the power supply is back, press the key SEND on the remote control to retransmit the automatic programming you previously set to the stove.

Fan fail

This alarm occurs in the event the smokes ejector is broken or the pcb cannot detect the speed of the smokes exhaust fan. In this case press the key On/Off to reset the alarm and contact the technical assistance.

Dep Sic fail

This alarm is signalled by the Leds ALF and ALC blinking on the control board.

It indicates two different possibilities: an obstruction in the flue or a possible overheating of the stove. In both cases the motor reducer to load the endless screw stops working and the stove switches off. Press the key On/Off to reset the alarm. Check the possible activation of the manual reset thermostat on the back of the stove (4). Unscrew the safety cap and press the key.

In the event you have the same problem more than once, please contact the technical assistance.

Sond fumi

This alarm occurs in the event the sensor for smokes temperature is broken or not connected. You will read the words Alarm Son fumi on the display. In this case press the key On/Off to reset the alarm and contact the technical assistance.

Serv

The signal "Serv" on the display means that the stove has reached 1200 hours working. Please contact an authorised technical service to arrange a supplementary maintenance.

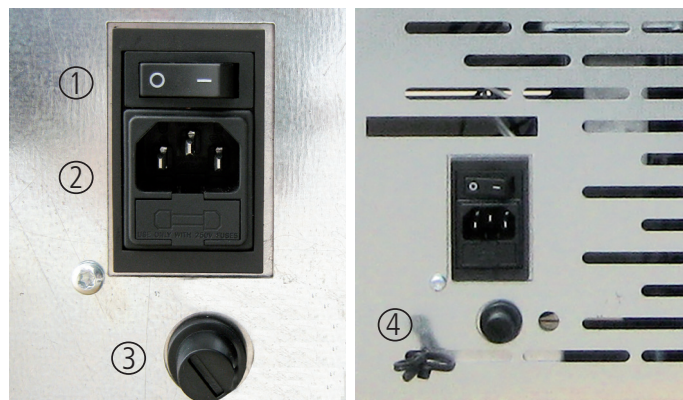

1. Lighting button
2. Fuse F4AL250V
3. Thermostat reset button
4. Environmental probe

Replace the batteries of the remote control

If you need to replace the batteries of the remote control, remove the back cover as shown in the picture. Replace the old batteries with the new ones respecting the polarity + and -. The batteries needed are AAA, 1,5 V.

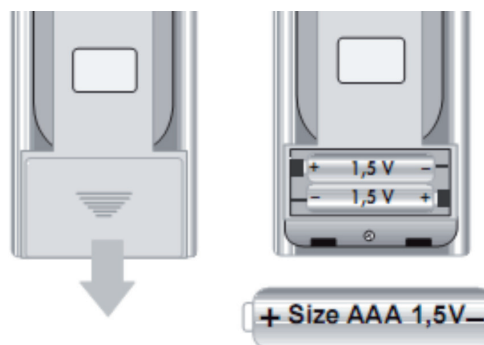

Regular checks should be carried out by the user, who should only contact the Authorized Assistance Center if no solution is found.

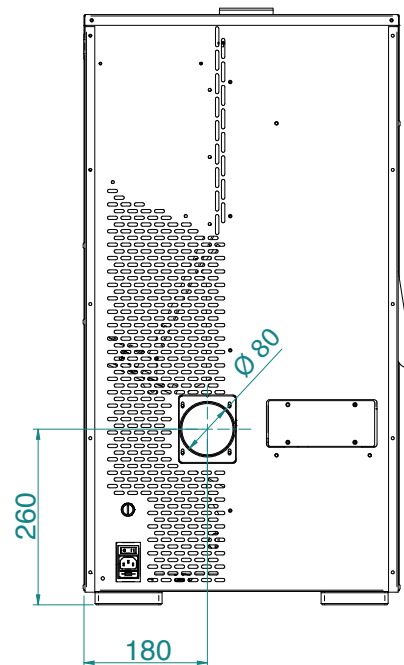
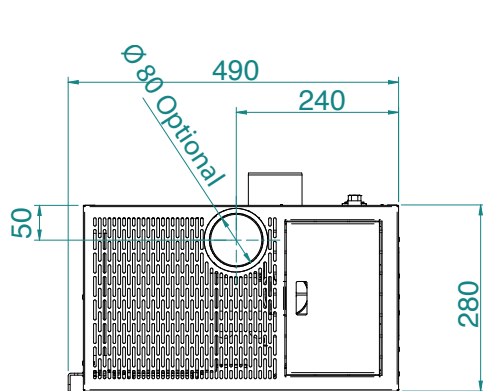
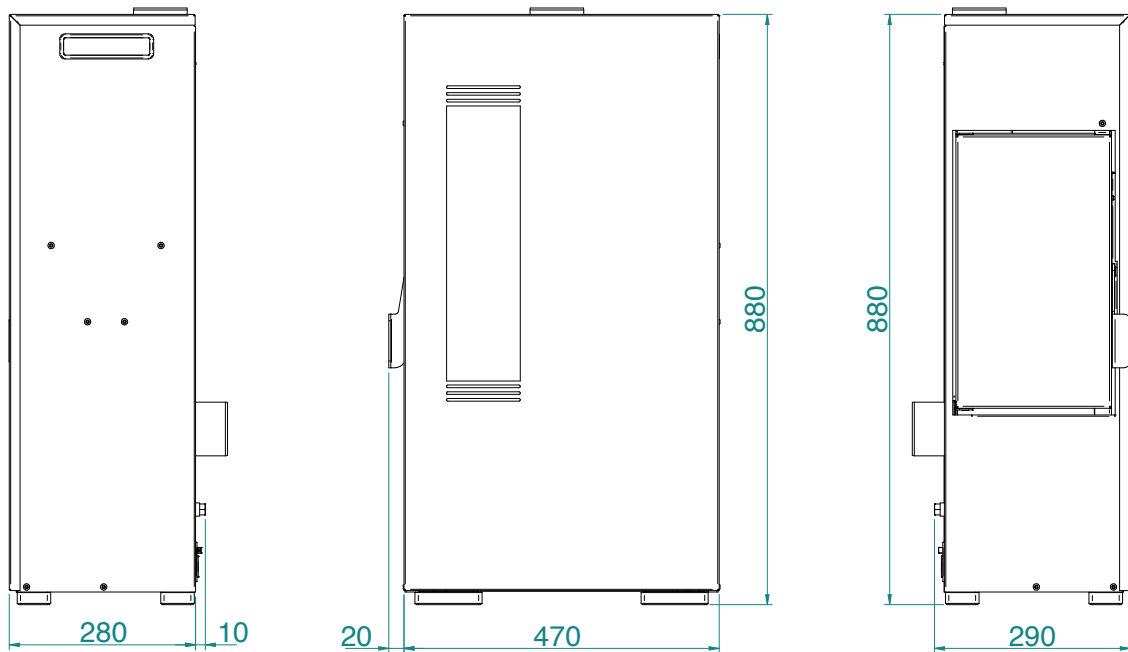

REMARKS:

- measurements are approximate and may vary based on to the aesthetics of the stove
- the positions of the tubes in the rear view are indicative and tolerance of +/- 10 mm
- measures with a tolerance of about 10 mm

PARAMETER	MEASURE UNITS	MINI 5
Heat input	kW	4,9
Nominal heat output	kW	4,4
Reduced nominal heat output	kW	2,1
CO concentration at nominal reference (13% O ₂)	mg/m ³	178
CO concentration at reduced reference (13% O ₂)	mg/m ³	488
Nominal efficiency	%	89,63
Reduced efficiency	%	92,32
Flue gas rate (min-max)	g/s	4,2 - 2,7
Draft advised (min-max)	Pa	3 - 10
Flue gas temperature (min-max)	°C	85 - 142
Tank capacity	Kg	11
Recommended fuel	(ø x H) mm	pellet 6 x 30
Heated surface	m ³	130
Diameter flue outlet tube	mm	80
Diameter air intake	mm	50
Nominal voltage	V	230
Nominal frequency	Hz	50
Ignition power consumption	W	315
Power consumption (min-max)	W	43 - 75
Stove weight	Kg	45
Energy class		A +
IEE		124
Environmental decree n. 186 of 7/11/2017		★★★★☆
N° Test Report		2003792
Powders at (13% O ₂) Ref. nominal heat input	mg/m ³	18

It is recommended to control emissions after installation.

Pellet

The pellets are cylinders of compressed wood, produced from sawdust and wood processing (chips and sawdust), generally produced by sawmills and carpenters. The binding capacity of the lignin contained in wood, allows to obtain a compact product without adding additives and foreign chemicals to the wood, is therefore obtained a natural fuel with high yield. The use of expired pellets or any other unsuitable material can damage parts of the thermostove and impair proper operation: this can lead to the termination of the guarantee, and its producer responsibility.

For our products use pellets diameter 6 mm, length 30 mm and a maximum of 8% and A1 certified according to the UNI EN ISO 17225-2 standard. Keep the pellets away from heat sources and not in humid environments or with explosive atmosphere.



Maintenance and cleaning of the stove

Before effecting any maintenance operation or cleaning on the stove, take the following precautions:

- be sure that all parts of the stove are cold.
- be sure that the ashes are completely cold.
- be sure that the general switch is in the "OFF" position.
- be sure that the plug is pulled out of the socket to avoid accidental contact.
- once the maintenance phase is completed check that everything is in order as per before the intervention (the brazier is placed correctly).



Follow carefully the following cleaning instructions. Failure to follow these instructions could create problems with the operation of the stove.

Cleaning the brazier and brazier support

When the flame assumes a red colour or seems weak, and is accompanied by black smoke, this means that there are ash deposits or incrustations that do not permit the correct functioning of the stove and that must be removed. Remove the brazier every day by simply raising it from its slot; then clean out the ashes and eventual incrustations that may have formed, paying particular attention to liberating the holes by using a pointed tool (not included with the stove).

This operation is made particularly necessary before every lighting the first several times and above all if using pellets that differ from those supplied by our company. The frequency of this operation is determined by how frequently the stove is used and the choice of pellets.

It is also a good idea to check the brazier support, vacuuming the eventual ash present.



Ash box

Open the door and use a vacuum to remove all the ash deposited inside the ash box. This operation must be performed more or less frequently depending on the quality of the pellets used.

Cleaning the glass

The glass is a self cleaning type, therefore, while the stove is working, a veil of air is blown across its surface to remove ash and dirt; nevertheless over a period of several hours, a greyish patina tends to form which should be cleaned when the stove is next shut down. How dirty the glass becomes also depends on the quality and quantity of pellets used.

Cleaning the glass should be done when the stove is cold with products recommended and tested by our company.

When performing this operation, always check that the grey seal around the glass is in a good state; failure to check the efficiency of this gasket can compromise the function of the stove.

Poor quality pellets can, in any case, cause the glass to become dirty.



If the glass is broken, do not attempt to light the stove.

Cleaning the surfaces

To clean the surfaces, use a rag dampened with water or with water and a neutral detergent.



The use of aggressive detergents or thinners can damage the surfaces of the stove. Before using any detergent it is advisable to try it on a small section out of sight or contact the Authorized Assistance Centre for information regarding the product.

Cleaning the metal parts

To clean the metal parts of the stove, use a soft cloth dampened with water. Never clean the metal parts with alcohol, thinners, petrol, acetone or other degreasing substances. If such substances are used, our company declines any responsibility.

Eventual variations in the colour of the metal parts can be caused by an incorrect use of the stove.



It is necessary to daily clean the brazier and often clean the ash box. The lack of cleanliness can prevent the starting of the stove, causing damages to the stove itself and to the environment (possible emission of unbrunt material and soot). Do not re-use the pellet possibly remained in the brazier due to no starting-up.

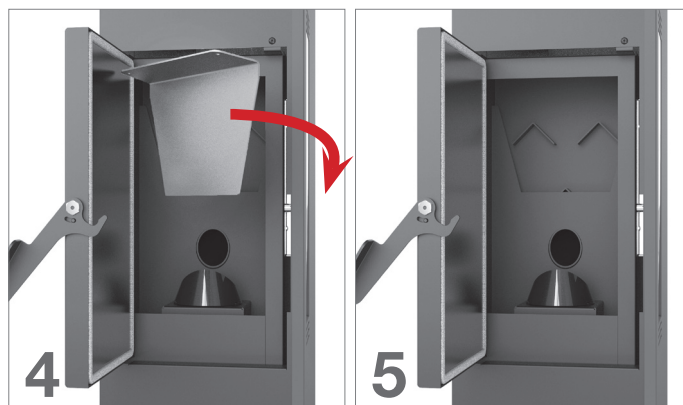

Disconnect the stove from the fume pipe and remove the inspection plate on the back (photo 6).

Remove the four screws and remove the plate (photo 7) to clean the compartment with an ash cleaner (photo 8).

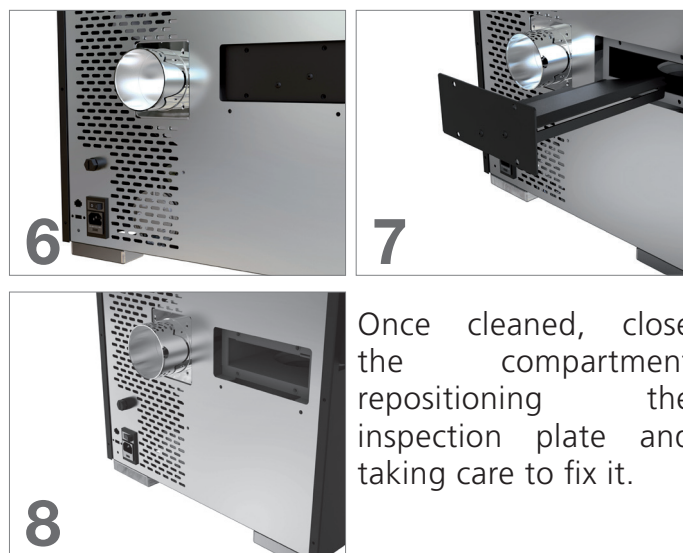

Once cleaned, close the compartment repositioning the inspection plate and taking care to fix it.

Cleaning the clearing system

Until a reasonable experience is acquired regarding the operating conditions, it is advisable to perform this maintenance on at least a monthly basis.

- remove the electrical feed cable;
- remove the cap from the T-joint and proceed with the cleaning of the ducts. If necessary, at least for the first few times, call in qualified personnel;
- carefully clean the smoke discharge system: for this, contact a professional chimney sweep;
- once a year clean the dust, cobwebs, etc. from the zone behind the internal covering panels, paying particular attention to the fans.

Cleaning the fans

The stove is furnished with fans (environmental and

CLEANING BY TECHNICIANS

Check every year

Clean the combustion chamber

Remove the brazier and clean it of any residue. (photo 1)

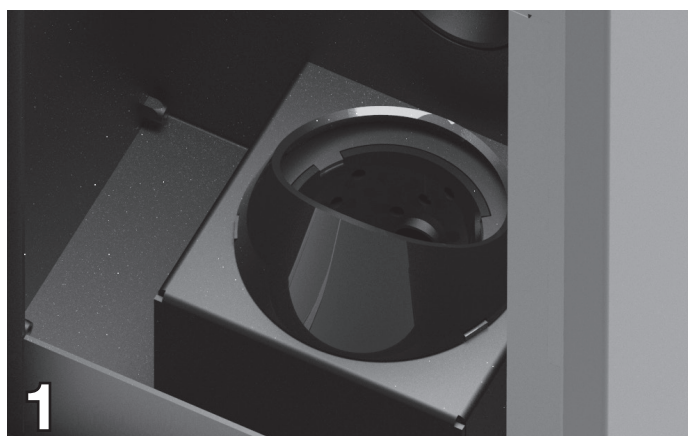

Open the door and lift the plate upwards as in pictures 2 and 3.

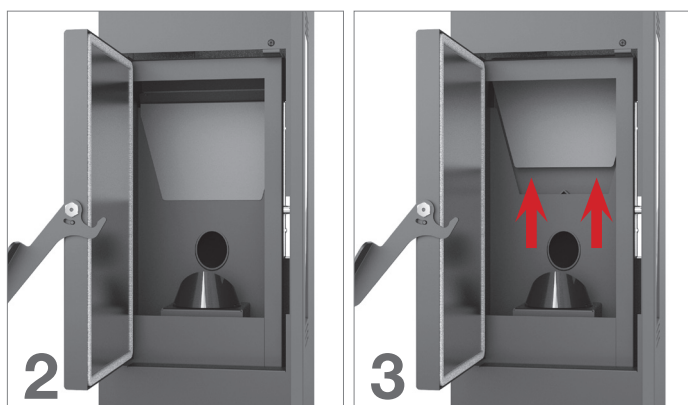

Rotate the plate (photo 4) and remove it. Clean the fume passage compartment by an ash cleaner (photo 5).

Refit the plates.

smoke) positioned at the rear and below the stove. Eventual deposits of dust or ash on the blades of the fan can cause an imbalance in the fans leading to noisy performance. It is, therefore, necessary to clean the fans at least once a year. Since said operation requires dismantling several parts of the stove, have the fans cleaned only by our Technical Assistance Centre.

Season end cleaning

At the end of the season, when the stove will not be used for some time, it is advisable to perform a thorough and general cleaning:

- Remove all the pellets from the container and the screw feeder;
- Carefully clean the brazier, the brazier support, the combustion chamber and the ash box.

Once the preceding points have been observed, it only means that the state of the stove has been verified. It is necessary to thoroughly clean the smoke discharge tube or flue and check the condition of the basket. If necessary, order a new one from our Authorized Assistance Centre.

If necessary, lubricate the hinges of the door and the handle. Also check the ceramic fibre cord near the glass, on the internal wall of the door; if it is worn or too dry, order a new one from the Authorized Assistance Centre.

Maintenance and cleaning



All cleaning of all parts must be carried out with the stove completely cold and unplugged to avoid burns and thermal shock. The stove does not need much maintenance if used with certified quality pellet. The need for maintenance varies depending on the conditions of use (switching on and off repeatedly) and depending on the performance required.

Parts	Everyday	Every 2-3 days	Every week	Every 15 days	Every 30 days	Every 60-90 days	Every year / 1200-1400 h
Brazier	◇						
Cleaning ash collection compartment		◇					
Cleaning the door and glass		◇					
Cleaning the interior heat exchanger / smoke fan compartment						•	
Cleaning complete exchanger							•
Clean "T" to exhaust						•	
Flue							•
Door gasket ash						•	
Internal parts							•
Flue pipe							•
Electromechanical components							•

◇ by the user

• by the authorised qualified technical assistance



Every 1200 hours of work the electronic board sends a warning signal and the display will show "SERVICE". This indicates the need for a thorough cleaning of the stove by a CAT. The lack of such cleaning could result in failure of the stove and poor combustion, thereby resulting in a lower yield.



Pressure switch: monitors depression in the smoke duct. It is designed to shut down the pellet feed screw in the event of an obstructed flue or significant back-pressure in the presence of wind. At the time of the pressure switch will show **“ALAR-DEP-FAIL”**.

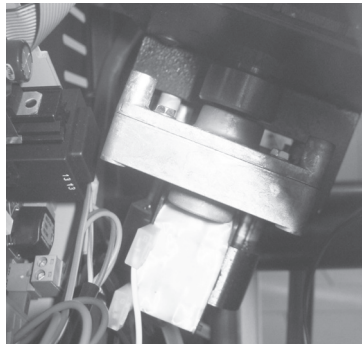

Reduction motor: if the motor stops, the thermostove continues to function until the flame goes out for lack of fuel, and until it has cooled down to the minimum level.

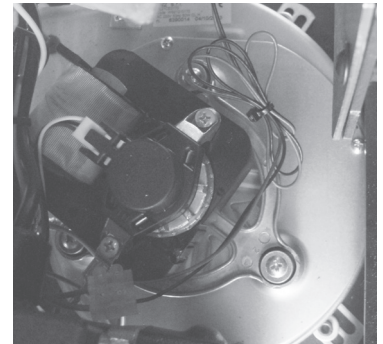

Flue gas temperature sensor: thermocouple that measures the temperature of the fumes while keeping the operation or shuts the thermostove when the flue gas temperature drops below the preset value.



Electrical safety: the stove is protected against violent surges of current (ex. lightnings) by the main fuse 4 A which is located on the control panel at the rear of the thermostove. Other fuses to protect the electronic boards are to be found on the boards themselves.



Pellets temperature safety: In the rare event there is a too high temperature in the tank, the thermostat for pellets safety with manual reset creates an alarm **“ALAR-SIC-FAIL”** stopping the pellet boiler stove. You need to reset the system working on the device placed on the back of the thermostove.



Room thermostat: the room thermostat detects the present temperature in the room. When it detects the set temperature on the display, the stove will go into operation in ECO ie hold function to save fuel. The room thermostat should be spread so as not to be conditioned by the temperature of the body stove.



Tampering with the safety devices is prohibited. It is only after eliminating the cause which gave rise to the intervention of the safety system, that it is possible to relight the stove and thus reset the automatic operation of the sensor. To understand which anomaly has occurred, consult this manual at paragraph relating to alarms which explains what to do based on the alarm message the stove display.

Problems and solutions



All repairs must be carried out exclusively by a specialised technician, with the stove completely cold and the electric plug pulled out. Is prohibited from any unauthorized modification to the device and the replacement of parts with other non-original. The operations marked in bold type must be carried out by specialised personnel.

Any inconvenience and solutions

Given that all stoves are tested in their parts handling and work and therefore are delivered in perfect physical condition and operation, it should be remembered that the transport, unloading, handling, misuse or poor maintenance, can be causes of drawbacks.

The main problems may be solved by reading the table below.

If after doing as hereinafter described the problem is not resolved, contact your authorized service center.

PROBLEM	POSSIBLE CAUSE	REMEDY
Display off and buttons are not working	<ol style="list-style-type: none"> 1. Power failure in the network 2. Switch back off 3. Display defective 4. Fault in the connection of the display with the card 5. Fuse board interrupted 6. Card defective 	<ol style="list-style-type: none"> 1. Check that the power cord is connected 2. Use the switch back to operate it 3. Unplug the stove from the power outlet for about one minute and then turn on. If the problem persists, contact an authorized service center 4. Check that the display and board are properly connected. Contact your authorized service center 5. Contact an authorized service center 6. Contact an authorized service center
Remote inefficient	<ol style="list-style-type: none"> 1. Too far from the stove 2. No batteries in the remote 3. The remote control is broken 	<ol style="list-style-type: none"> 1. Move closer to the stove 2. Check and change the batteries 3. Replace the remote control
Failure to ignite the stove	<ol style="list-style-type: none"> 1. Excessive accumulation of ash in the grate 2. Incorrect ignition procedure 	<ol style="list-style-type: none"> 1. Clean the grate 2. Repeat the ignition procedure. If persists, contact your authorized service center
Smoke comes from the grill	<ol style="list-style-type: none"> 1. Accidental electrical blackout 	<ol style="list-style-type: none"> 1. In case of ignition phase interrupted and momentary interruption of the fan, can occur slight amount of smoke
Hot air fan is not working	<ol style="list-style-type: none"> 1. The stove has not yet been heated 	<ol style="list-style-type: none"> 1. Wait until the conclusion of the ignition cycle. Arrived in temperature, the fan will start automatically. If the problem persists, contact your authorized service center.

<p>The stove does not turn on automatically</p>	<ol style="list-style-type: none"> 1. The tank is empty. 2. The resistance does not reach the temperature 3. Resistance damaged 4. The pellet drops 5. Screw motor defective 6. The grate is not in place or is dirty 7. Obstruction of nests or foreign bodies in the chimney or fireplace 8. Check operation of the glow plug 9. The ash drawer is not closed properly 10. Clogged flue and chimney 11. Smoke extractor not working 12. Temperature sensor defective 13. Pellet wet 	<ol style="list-style-type: none"> 1. Fill the tank with pellets 2. Check the electrical wiring and fuses, replace if the resistance is broken 3. Replace the resistance 4. It is recommended to unplug the power supply before: <ul style="list-style-type: none"> - check that the pellet is not caught in the chute - check that the cochlea is not blocked by dirt - check the seal of the pellet-door 5. Contact an authorized service center 6. Check that the hole in the brazier matches the glow plug, clean brazier 7. Remove any foreign body from the chimney or flue pipe 8. Make sure that there is power. Replace the spark plug if burned 9. Close the drawer ashtray 10. Perform periodic cleaning 11. Check the operation of the extractor flue 12. Contact an authorized service center 13. Make sure the place of stowage pellet and replace it with a handful of dry pellets
<p>Lock the stove. Pellets not being fed into the combustion chamber</p>	<ol style="list-style-type: none"> 1. The tank is empty 2. The cochlea is no pellet 3. Technical problem of the cochlea 4. Reduction motor failure 5. Electronic board faulty 	<ol style="list-style-type: none"> 1. Load the pellets in the tank. 2. Fill the tank and proceed as instructed before ignition stove 3. IT IS RECOMMENDED to unplug the power supply before: <ul style="list-style-type: none"> - empty the tank and manually free the auger from obstructions (sawdust) - release the slide from obstructions - remove the dust accumulation of pellets in the bottom of the tank 4. Replace the reduction motor 5. Replace the electronic board
<p>The stove runs for a few minutes and then turn off</p>	<ol style="list-style-type: none"> 1. Lighting cycle not completed 2. Temporary failure of electricity 3. Probes fumes defective or broken or not inserted 	<ol style="list-style-type: none"> 1. Re-run power 2. Re-run power 3. Check and replace sensors
<p>Fume extraction fan does not stop</p>	<ol style="list-style-type: none"> 1. The stove has not yet cooled 	<ol style="list-style-type: none"> 1. Allow the stove to cool. Only after cooling fan will stop. <p>If the problem persists, contact your authorized service center</p>

<p>The stove is clogged early in the brazier with burning irregular, door glass gets dirty, the flame is long, reddish and weak</p>	<ol style="list-style-type: none"> 1. Flue with presence of stretches too long or clogged 2. Too pellet 3. Excessive pellet or ash deposits in the brazier 4. The brazier is not found in its slot 5. Wind contrary to the exhaust flow 6. Insufficient combustion air 7. You changed the type of pellets used 8. Smoke extractor motor broken 9. Door closed incorrectly 	<ol style="list-style-type: none"> 1. Perform periodic cleaning. See paragraph stove installation in the user manual. Check chimney cleaning 2. Decrease in the parameters the charge level of the pellets 3. Clean the brazier after waiting for the total shutdown of the stove. If you repeat contact your Authorized Service Center 4. Check that the hole in the brazier matches the glow plug 5. Check the chimney cap windproof and / or possibly install it 6. Check the correct position of the brazier, its cleanliness and check that the air intake in both free environment, verify the status of the door seal, increase the level in the parameter relative to the speed of the fan exhaust fumes. Contact your Authorized Service Center 7. Check the quality of the pellets. Contact your Authorized Service Center 8. Increase the level in the parameters relating to the speed of the fan exhaust fumes. Check and eventually replace motor 9. Check that the glass is sealed and the seal guarantees tightness
<p>Smell of smoke in the environment. Turning off the stove.</p>	<ol style="list-style-type: none"> 1. Poor combustion 2. Malfunction of fan fumes 3. Installation of the flue performed incorrectly 4. Clogged chimney 	<ol style="list-style-type: none"> 1. Contact your Authorized Service Center 2. Contact your Authorized Service Center 3. Contact your Authorized Service Center 4. Contact your Authorized Service Center
<p>In the automatic position the stove always runs at full power</p>	<ol style="list-style-type: none"> 1. Room thermostat set to maximum 2. Significant temperature sensor failure 3. Control panel defective or broken 	<ol style="list-style-type: none"> 1. Reset the thermostat temperature 2. Check the operation of the sensor and replace if necessary 3. Check the control panel and replace if necessary
<p>The engine smoke extraction does not work</p>	<ol style="list-style-type: none"> 1. The stove has no voltage 2. The motor is broken 3. The board is defective 4. The control panel has failed 	<ol style="list-style-type: none"> 1. Check the supply voltage and the protection fuse. 2. Check the motor and capacitor and replace if necessary. 3. Replace the circuit board. 4. Replace the control panel.

<p>The fire goes out or the stove stops automatically</p>	<ol style="list-style-type: none"> 1. The pellet tank is empty 2. No power 3. Pellets not being fed 4. Excessive deposit of ashes in the grate 5. Intervention probe temperature safety of the pellet 6. Cochlea blocked by dirt 7. The door is not closed properly or gaskets worn 8. Pellet inadequate 9. Low pellet 10. Chimney or drain clogged with nests or foreign bodies 11. Pressure switch cuts 12. Smoke extraction motor failure 13. Alarm active 	<ol style="list-style-type: none"> 1. Fill the tank with pellets 2. Check plug and presence electricity 3. Fill the tank with pellets 4. Clean the brazier 5. Let the stove cool down completely, reset the manual reset and restart the stove. If the problem persists, contact your authorized service representative 6. Pull the plug, empty the tank, remove any foreign objects 7. Close the door or replace the gaskets with original 8. Change the type of pellet recommended by the manufacturer. Sometimes, depending on the type, the stage of adjustment of the parameters need to vary the level relating to the loading of pellets 9. Increase the level in the parameter for the pellet feed. To check the flow of fuel from technical authorized 10. Eliminate all foreign matter from the chimney Clean the smoke duct. Perform periodic cleaning. 11. Verify potential smoke duct is blocked and if the pressure switch is working properly 12. Check and replace the motor if necessary 13. See paragraph alarms
<p>The air fan convention (ambient air) never stops</p>	<ol style="list-style-type: none"> 1. Temperature sensor temperature control defective or broken 2. Smoke probe fails 	<ol style="list-style-type: none"> 1. Check the operation of the sensor and replace if necessary 2. Replace smoke probe
<p>The stove does not light.</p>	<ol style="list-style-type: none"> 1. Lack of electricity 2. Probe pellets in bulk 3. Fuse blown 4. Pressure switch broken (lockout indicated) 5. Smoke outlet or duct clogged 	<ol style="list-style-type: none"> 1. Check that the electrical outlet is plugged in and the power switch to "I" 2. Lockout by resetting the rear thermostat, replace the thermostat if it happens again 3. Replace the fuse 4. Replace the pressure 5. Clean the smoke outlet and / or smoke duct



The manufacturer of the stove any liability and will void the warranty terms of the product for any inconvenience caused by not following the rules described above. Any work of service center will be borne by the applicant if they are not complied with these instructions.

GENERAL GUARANTEE

All products are subject to accurate testing and are covered by warranty for 24 months from the date of purchase, documented by invoice or purchase receipt that will be presented to authorized technicians. If the document does not show up, it will be invalidate the right of the owner of the appliance. Warranty means the replacement or repair of parts of the appliance that are defective at source due to manufacturing faults.

1. Warranty covering manufacturing defects and defects in material declines:

- for unauthorized personnel work;
- for damage caused by transport or for causes not attributable to the manufacturer;
- for incorrect installation;
- for incorrect electrical connection;
- for periodic maintenance not performed;
- for outdoor accidents (lightning, floods, etc ...);
- for incorrect use and maintenance.

2. Complete replacement of the machine can only take place following the unquestionable decision by the manufacturer in special cases

3. The Company declares no responsibility for any damage that may, directly or indirectly, result in persons, things or animals as a result of non-observance of the instructions in the Instructions book and in particular concerning the installation, use and maintenance of the appliance.

GUARANTEE LIMITATIONS

Limited Warranty covers manufacturing defects, provided that the product has not been damaged by improper use, improper handling, incorrect connection, tampering, and installation errors. The following components are covered by a twelve months warranty:

- combustion burners;
- resistance.

They are not covered by warranty:

- the glass of the door;
- general gasket and fiber door;
- painting;
- tiles;
- the remote control
- Internal sides
- Any damage caused by inadequate installation and / or shortages of the consumer.

The images are purely indicative and may not match the reality of the product. Pictures are only exemplary and they are needed to understand how the product works.